



www.wima.com



MADE IN GERMANY



AEC-Q200 ACCORDANT

REACH COMPLIANCE

CONFLICT MINERALS DECLARATION

TECHNICAL SUPPORT/DESIGN-IN

WIMA PROCESS CONTROL SYSTEM

SHIP-TO-STOCK DELIVERIES

Film Capacitors for Electronic Equipment

Edition 2023/2024



■ SMD Plastic Film Capacitors Size Codes 1812 to 6054	Polyester film, metallized	WIMA SMD-PET	17
	Polyethylene-naphthalate film, metallized	WIMA SMD-PEN	21
	Polyphenylene-sulphide film, metallized	WIMA SMD-PPS	25
■ Subminiature Capacitors PCM 2.5 mm	Polypropylen film, film/foil	WIMA FKP 02	30
	Polyester film, metallized	WIMA MKS 02	32
■ Film/Foil Capacitors PCM 5 mm	Polyester film, film/foil	WIMA FKS 2	35
	Polypropylene film, film/foil	WIMA FKP 2	37
■ Film/Foil Capacitors PCM 7.5 to 15 mm	Polyester film, film/foil	WIMA FKS 3	40
	Polypropylene film, film/foil	WIMA FKP 3	43
■ Metallized Capacitors PCM 5 mm	Polyester film, metallized	WIMA MKS 2	48
	Polypropylene film, metallized	WIMA MKP 2	51
■ Metallized Capacitors PCM 7.5 to 52.5 mm	Polyester film, metallized	WIMA MKS 4	54
	Polypropylene film, metallized	WIMA MKP 4	61
■ Pulse Duty Capacitors PCM 7.5 to 52.5 mm	Polypropylene film, double-sided metallized electrode	WIMA MKP 10	67
	Polypropylene film, metal foil/single-sided metallized film	WIMA FKP 4	78
	Polypropylene film, metal foil/double-sided metallized film	WIMA FKP 1	81
■ RFI-Capacitors PCM 7.5 to 37.5 mm	Polypropylene film, metallized Class X2	WIMA MKP-X2	90
	Polypropylene film, metallized Class Y2	WIMA MKP-Y2	95
	Polypropylene film, metallized Class X1	WIMA MKP-X1 R	98
■ Filter Capacitors	Polypropylene film, metallized	WIMA MKP 4F	103
■ Snubber Capacitors	Polypropylene film, double-sided metallized electrode	WIMA Snubber MKP	110
	Polypropylene film, metal foil/metallized film	WIMA Snubber FKP	116
■ GTO Capacitors	Polypropylene film, double-sided metallized electrode	WIMA GTO MKP	124
■ DC-LINK Capacitors	Polypropylene film, metallized	WIMA DC-LINK MKP 4	129
	Polypropylene film, metallized	WIMA DC-LINK MKP 6	142
	Polypropylene film, metallized	WIMA DC-LINK HC	148
	Polypropylene film, metallized	CUSTOMIZED	150
■ PowerBlock	Double-Layer capacitor (SuperCap) modules	WIMA PowerBlock	152
■ General Information	Explanation of important terminology		3
	Construction principles of WIMA film capacitors		4
	Typical characteristics and graphs of the plastic film dielectric used		5
	Technical data and advantages of WIMA capacitors		9
	Selection of WIMA capacitors for pulse applications		11
	Recommendation for processing and application of WIMA capacitors		13
	WIMA quality and environmental philosophy		15
	WIMA part number system		155
	Types of packaging and packing units for WIMA capacitors		156
	WIMA representations		161

General Information

Explanation of Important Terminology

Nominal Capacitance

The nominal capacitance of a capacitor is usually given in pF, nF or μF .

Operating/Rated Voltage

Each capacitor is designed for a specified rated voltage in continuous operation. This is usually only valid for ambient temperatures of $T \leq +85^\circ\text{C}$. In the case of higher temperatures a derating factor must be applied to the rated voltage from 85°C .

Insulation Resistance/Time Constant

The insulation resistance is normally expressed in megohms ($\text{M}\Omega$) and is measured at a specified voltage after 1 minute. The time constant defines the time in seconds, in which the voltage across the capacitor self-discharges to 37% of the fully charged state and it is expressed as $\tau = R_{is} \times C$. The insulation resistance or time constant value denotes the quality of the dielectric insulation.

Dissipation Factor

The dissipation factor $\tan \delta$ is the quotient of the resistive and reactive parts of the impedance. The dielectric losses are illustrated by R in the equivalent circuit diagram. The insulation resistance R_{is} is in parallel with R, and affects the $\tan \delta$ only at very low frequencies. The dissipation factor is also affected by the resistance of both electrodes and of the termination – electrode interface. This is represented by the series resistance r. L represents the remaining self-inductance.

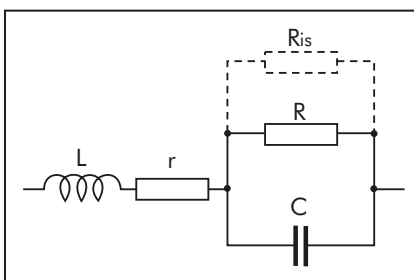

Capacitance Tolerance

The tolerance is the permissible actual capacitance relative to the nominal capacitance and it is defined in per cent. The tolerance is to be measured at $+25^\circ\text{C}$ and the permissible tolerance is only valid at the time of shipment. The capacitance may change after long storage or long usage. The tolerance, with the exception of $\pm 20\%$, is usually marked on the capacitor body in clear digits.

Temperature Coefficient of Capacitance

The temperature coefficient α expresses the change in capacitance with temperature, relative to the capacitance at the reference temperature of $+20^\circ\text{C}$; it is usually expressed in ppm per $^\circ\text{C}$.

$$C_T = C_{20} \times [1 + \alpha \times (T - 20^\circ\text{C})]$$

C_{20} = capacitance at $+20^\circ\text{C}$

C_T = capacitance at T

α = may be positive or negative.

Pulse Stressing

The ratings on pulse rise time are based on tests in accordance with DIN-IEC 60384 part 1. The test voltage corresponds to the rated voltage and the test comprises 10000 pulses with a repetition frequency of 1 Hz. The catalogue ratings are in accordance with the CECC specifications which specify that the test pulse rise time shall be 10 times the catalogue rating. It should also be noted that the pulse rise time (F) i.e. $\text{V}/\mu\text{sec}$ also provides the maximum current capability, as it can be determined from the following formula.

$$I = F \times C \times 1.6$$

C in μF / I in amps.

The information on the pulse rise time refers to pulses equal to the rated voltage so that, at lower operating voltages, the permissible pulse rise times may be increased.

Warning Notice/Technical Support

AC voltage load at the mains

Anticipating possible interfering pulses, DC

voltage capacitors must not be operated at the mains (power line), irrespective of the rated AC voltage. For this purpose, use approved interference suppression capacitors only.

Thermal load in the application

If a plastic film capacitor is overstressed due to inappropriate usage under AC voltage conditions, the temperature inside the component may rise to an impermissibly high level. Thus, the dielectric film may subsequently be damaged leading to a short circuit or formation of smoke and even fire in the capacitor.

This may also happen if the capacitor is overheated by an external heat source.

Shock and/or vibration load for larger case sizes

For increased shock and vibration applications involving larger case sizes (i.e., PCM 22.5 mm pin spacing or greater), it is recommended to fix capacitors in an appropriate way; or special pin and plate terminations may be required respectively to minimize lead separation from the capacitor element or the solder joint.

Processing

When processing plastic film capacitors it is mandatory to observe the application recommendations with regard to soldering and/or cleaning and drying processes.

General remarks

All catalogue data, range surveys and application data correspond to the actual state of the art and were elaborated as thoroughly and precisely as possible. They are to be understood as general information, and the right for amendments and construction changes is reserved. Special customized designs which deviate from our catalogue data, irrespective of whether being based on factory standards, specifications or related data, do not release the user from his duty of care with regard to incoming goods inspection and production monitoring. In case of the components being purchased through second or third suppliers we urgently ask to compare the technical details with the data given by the manufacturer. In cases of doubt we recommend use is made of our technical support, since we do not take any responsibility for damages caused by inappropriate use or processing of our capacitors.

Construction Principles of WIMA Capacitors

Film and Foil Construction

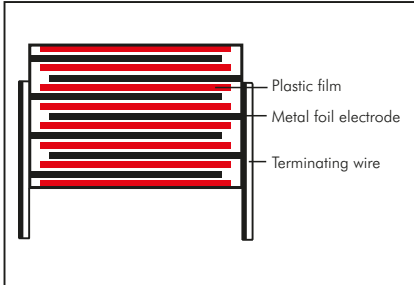

WIMA Types:

FKP 02	FKS 2	FKP 2
FKS 3	FKP 3	

Metallized Construction

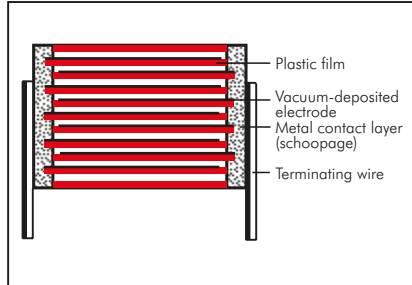

WIMA Types:

SMD-PET	SMD-PEN	SMD-PPS
MKS 4	MKP 4	MKP-X2

Advantages of Film/Foil Construction:

- High pulse and current rating
 - High insulation resistance
 - Close tolerances up to $\pm 1\%$
- Disadvantages: short circuit at end of life

Advantages of Metallized Construction:

- High capacitances in small box sizes
 - Excellent self-healing ability
 - Very good price/performance ratio
- Disadvantage: low pulse resistance

MKS 02	MKS 2	MKP 2
DC-LINK MKP 4	DC-LINK MKP 6	DC-LINK HC

Film and Foil Construction with Internal Series Connection and Self-Healing, Metallized Plastic Film

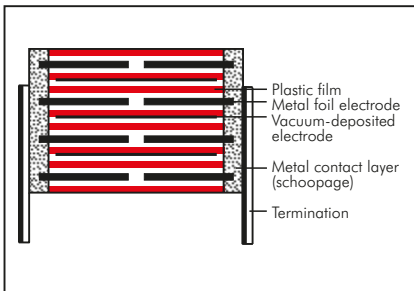

WIMA Types:

FKP 4	Snubber FKP
-------	-------------

Film and Foil Construction with Internal Series Connection and Self-Healing Plastic Film Metallized on Both Sides

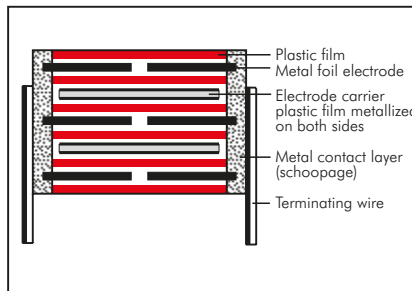

WIMA Types:

FKP 1

Pulse Duty Construction with Self-Healing Plastic Film Metallized on Both Sides

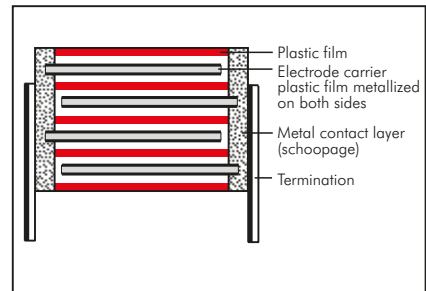

WIMA Types:

MKP 10*	GTO MKP*
---------	----------

*up to 250 VAC *up to 250 VAC

Pulse Duty Construction with Internal Series Connection and Self-Healing Plastic Film Metallized on Both Sides

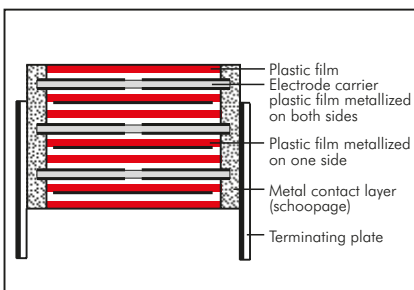

WIMA Types:

MKP 10*	Snubber MKP	GTO MKP*
---------	-------------	----------

*400 to 700 VAC

*from 400 VAC

Metallized Construction with Internal Series Connection

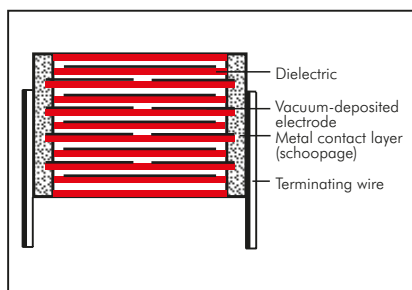

WIMA Types:

MKS 4*	MKP 4*	MKP 4F
--------	--------	--------

*400 VAC *400 VAC

MKP-X1 R	MKP-Y2
----------	--------

Typical Characteristics and Graphs of the Polyester (PET) Film



Polyester Film and Foil Types

FKS 2

FKS 3

Metallized Polyester Types

SMD-PET

MKS 02

MKS 2

MKS 4

Typical Applications

For general DC-applications e.g.

- By-pass
- Blocking
- Coupling and decoupling
- Timing

Film Properties

Dielectric constant

at 1 kHz and +23° C:

3.3 positive as temperature rise

Specific volume resistance

in Ω cm at +23° C:

10^{18}

Dielectric strength (DC voltage)

in V/ μ m at +23° C:

580

Preferred temperature range

in ° C:

-55 to +105 (125)

Dielectric absorption

in % at + 23° C:

0.20 to 0.25

Typical Graphs

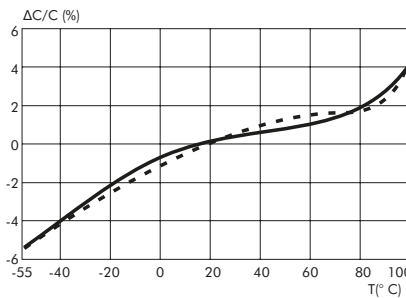

Capacitance change versus temperature (f=1 kHz) (general guide)

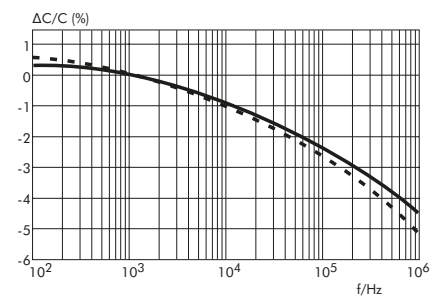

Capacitance change versus frequency (general guide)

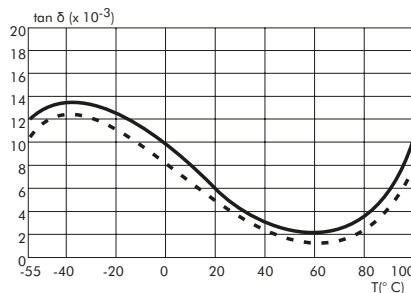

Dissipation factor change versus temperature (f=1 kHz) (general guide)

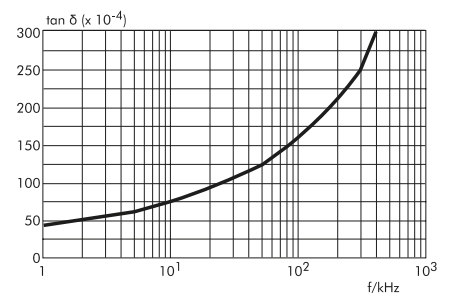

Dissipation factor change versus frequency. Example: MKS 4, 0.1 μ F/400VDC (general guide)

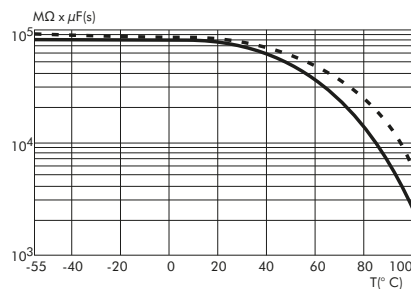

Insulation resistance change versus temperature (general guide)

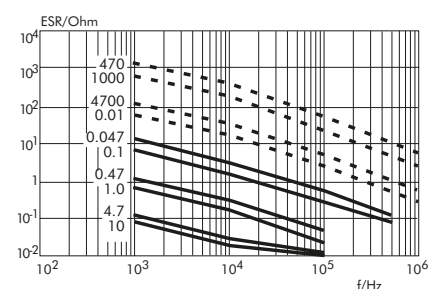

ESR change versus frequency (general guide)

The broken lines show the film and foil types.

The full lines characterize the metallized versions.



Typical Characteristics and Graphs of the Polypropylene (PP) Film

Polypropylene Film and Foil Types

- FKP 02
- FKP 2
- FKP 3
- FKP 4
- FKP 1
- Snubber FKP

Metallized Polypropylene Types

- MKP 2
- MKP 4
- MKP 10
- MKP-X2
- MKP-X1 R
- MKP-Y2
- MKP 4F
- Snubber MKP
- GTO MKP
- DC-LINK MKP 4
- DC-LINK MKP 6
- DC-LINK HC

Typical Applications

For high frequency and high pulse applications e.g.

- Sample and hold
- Timing
- LC-Filtering
- Oscillating circuits
- Audio equipment
- High frequency coupling and decoupling
- TV and monitor sets
- Lighting
- Power electronics

Film Properties

Dielectric constant

at 1 kHz and +23° C:
2.2 negative as temperature rise

Specific volume resistance

in Ω cm at +23° C:
 6×10^{18}

Dielectric strength (DC voltage)

in V/ μ m at +23° C:
650

Preferred temperature range

in ° C:
-55 to +100 (105)

Dielectric absorption

in % at + 23° C:
0.05 to 0.10

Typical Graphs

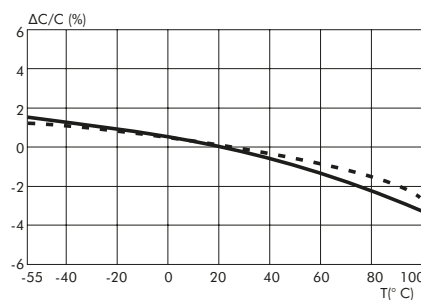

Capacitance change versus temperature (f=1 kHz) (general guide)

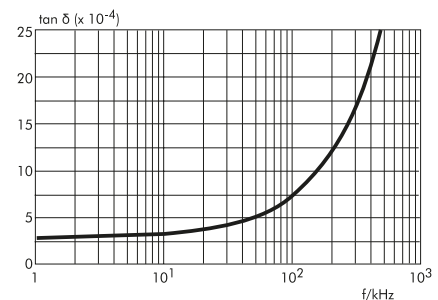

Dissipation factor change versus frequency. Example: MKP 10, 0.01 μ F/400VDC (general guide)

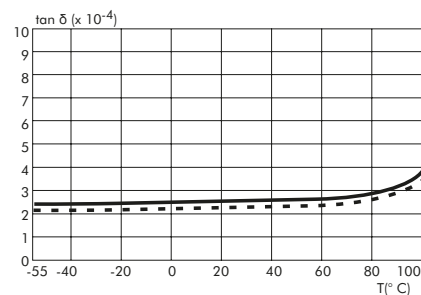

Dissipation factor change versus temperature (f=1 kHz) (general guide)

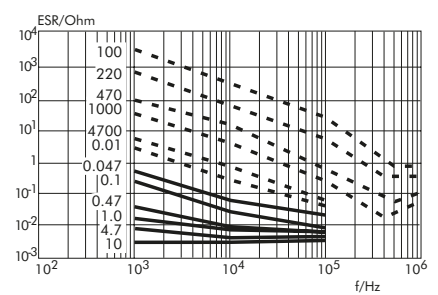

ESR change versus frequency (general guide)

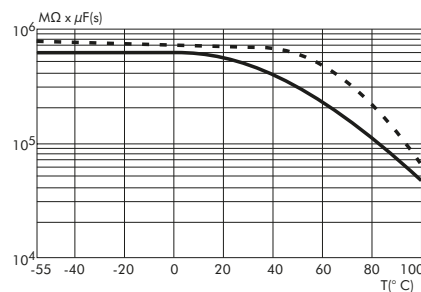

Insulation resistance change versus temperature (general guide)

The broken lines show the film and foil types.

The full lines characterize the metallized versions.

Typical Characteristics and Graphs of the Polyethylene-Naphthalate (PEN) Film



Metallized Polyethylene-Naphthalate Type

SMD-PEN

Typical Applications

For general DC-applications e.g.

- By-pass
- Blocking
- Coupling and decoupling
- Timing

Film Properties

Dielectric constant

at 1 kHz and +23° C:

3.0 positive as temperature rise

Specific volume resistance

in Ω cm at +23° C:

10^{18}

Dielectric strength (DC voltage)

in V/ μ m at +23° C:

580

Preferred temperature range

in ° C:

-55 to +125

Dielectric absorption

in % at + 23° C:

1.0

Typical Graphs

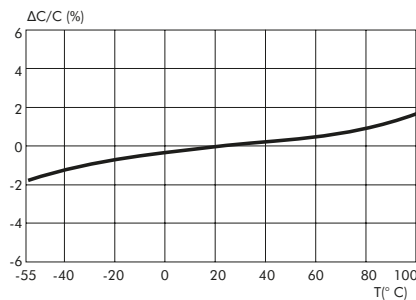

Capacitance change versus temperature ($f=1$ kHz) (general guide)

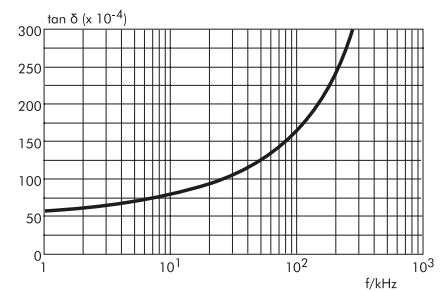

Dissipation factor change versus frequency. Example: SMD-PEN, 0.1 μ F/250 VDC (general guide)

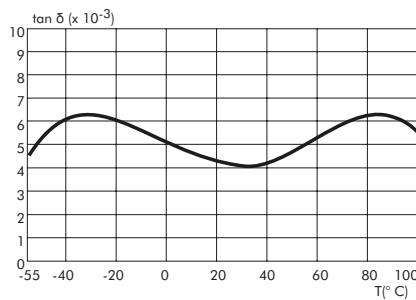

Dissipation factor change versus temperature ($f=1$ kHz) (general guide)

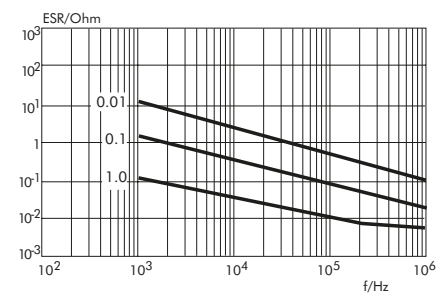

ESR change versus frequency (general guide)

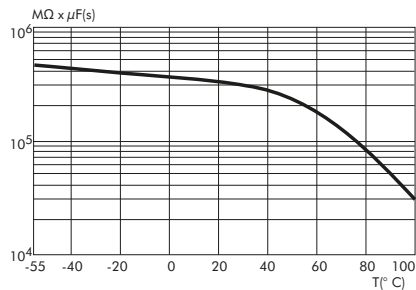

Insulation resistance change versus temperature (general guide)

Typical Characteristics and Graphs of the Polyphenylene-Sulphide (PPS) Film



Metallized Polyphenylene-Sulphide Type

SMD-PPS

Typical Applications

For general applications in high frequency and high temperature circuits e.g.

- By-pass
- Blocking
- Coupling and decoupling
- Timing
- Filtering
- Oscillating circuits
- TV and monitor sets
- Lighting
- Automotive electronics

Film Properties

Dielectric constant

at 1 kHz and +23° C:

3.0 very constant versus temperature

Specific volume resistance

in Ω cm at +23° C:

5×10^{17}

Dielectric strength (DC voltage)

in V/ μ m at +23° C:

470

Preferred temperature range

in ° C:

-55 to +140

Dielectric absorption

in % at + 23° C:

0.05 to 0.10

Typical Graphs

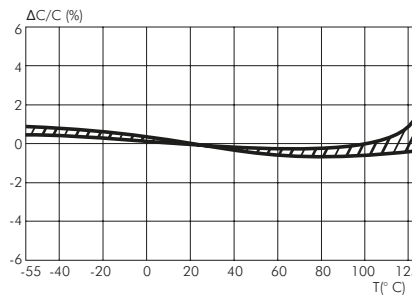

Capacitance change versus temperature (f=1 kHz) (general guide)

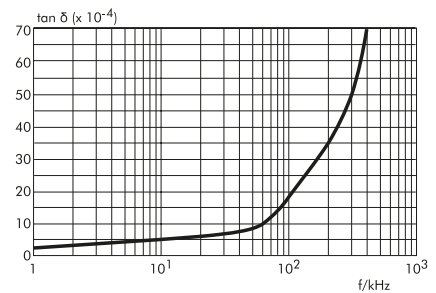

Dissipation factor change versus frequency. Example: SMD-PPS, 0.1 μ F/63 VDC (general guide)

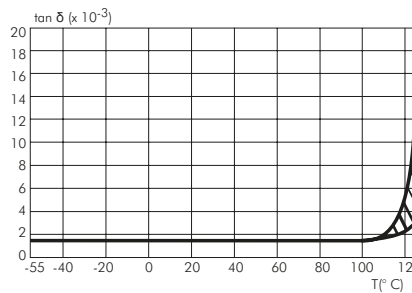

Dissipation factor change versus temperature (f=1 kHz) (general guide)

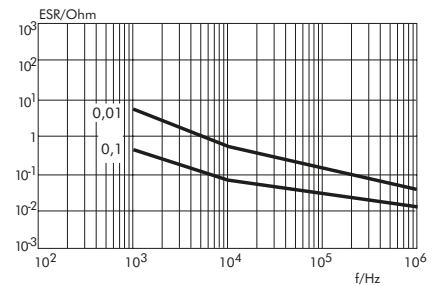

ESR change versus frequency (general guide)

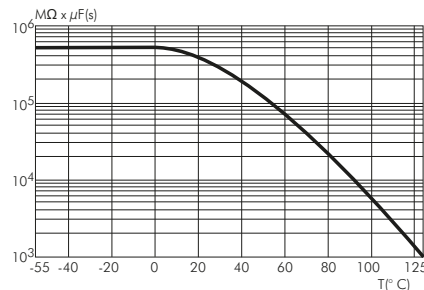

Insulation resistance change versus temperature (general guide)

Characteristics of Metallized Film Capacitors in Comparison with Other Dielectrics

	PET	PP	PEN	PPS	NPO	X7R	Tantalum
Dielectric constant 1 kHz/23° C	3.3 positive as temperature rise	2.2 negative as temperature rise	3.0 positive as temperature rise	3.0 very constant versus temperature	12 ... 40	700...2000	26
Operating temp. (° C)	-55...+105 (125)	-55...+100 (105)	-55...+125	-55...+140	-55...+125	-55...+125	-55...+125
Dielectric absorption (%)	0.2 ... 0.25	0.05 ... 0.10	1.0	0.05	0.6	2.5	n. a.
$\Delta C/C$ versus temperature (%)	± 5	± 2.5	± 5	± 1.5	± 0.3	± 15	± 10
$\Delta C/C$ versus voltage (%)	negligible	negligible	negligible	negligible	negligible	-20	negligible
ΔC aging rate (%/h decreasing)	negligible	negligible	negligible	negligible	negligible	2	n. a.
Dissipation factor (%)							
1 kHz	0.8	0.05	0.8	0.2	0.10	2.5	8
10 kHz	1.5	0.08	1.5	0.25	0.10		
100 kHz	3.0	0.25	3.0	0.5	0.10		
ESR	low	very low	low	very low	low	moderate	high
Ris (M Ω x μ F)							
25° C	10 000	100 000	10 000	10 000	10 000	1 000	100
85° C	1 000	10 000	1 000	1 000	1 000	500	10
Capacitance range from pF to μ F	1 000 ... 680	27 ... 400	10 000 ... 1.0	10 000 ... 2.2	1... 0.1	100 ... 2.2	100 000 ... 1 000
Capacitance tolerance (\pm %)	5/10/20	1/2.5/5/10/20	5/10/20	2.5/5/10/20	5/10	10/20	10/20
Self-healing	yes	yes	yes	yes	no	no	no
Typical failure mode at end of life	open	open	open	open	short	short	short
Reliability	high	high	high	high	high	moderate	low
Piezoelectric effect	no	no	no	no	no	yes	yes
Resistance to thermal and mechanical shock	high	high	high	high	moderate to low	moderate to low	high
Polarity	no	no	no	no	no	no	yes

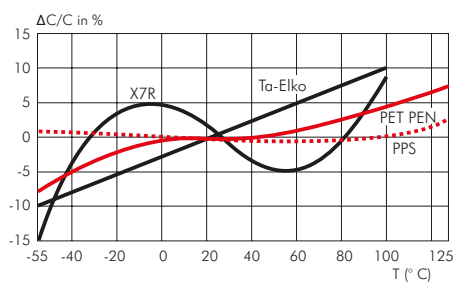

Capacitance change versus temperature (f = 1 kHz) (general guide)

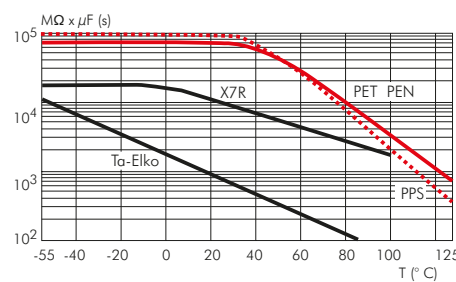

Insulation resistance change versus temperature (general guide)

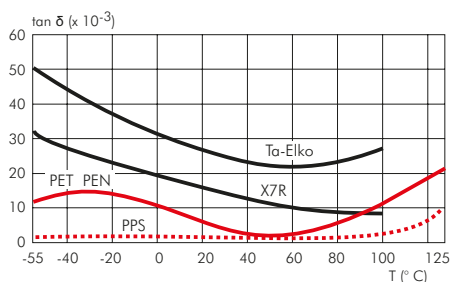

Dissipation factor change versus temperature (f = 1 kHz) (general guide)

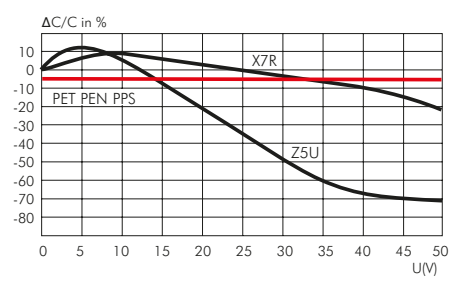

Capacitance change versus voltage (general guide)

Technical Data and Advantages of the Film Capacitors

Reliability

The failure rate in fit ($10^{-9}/h$) for plastic film capacitors is shown in the formula:

$$\lambda = \lambda_0 \times \pi_T \times \pi_V$$

λ_0 = expected value
 π_T = temperature factor
 π_V = voltage factor

The expected value has been determined for each component on the basis of life tests. If such a test is carried out at e.g. $T=85^\circ C$, this corresponds to an operating time of approx. 150 000 - 200 000 h in an equipment with $\leq 40^\circ C$ ambient temperature. Nowadays the best values are achieved by our metallized Polyester film capacitors with an expected value of 2 fit and a failure rate of $\lambda=10$ fit.

Self-Healing

The self-healing process in metallized plastic film capacitors is started by an electric breakdown, which takes about 10^{-8} sec. Temperatures of approximately 6000 K occur and evaporate the metallization around the failure spot. Insulated areas are formed and the capacitor continues to function properly.

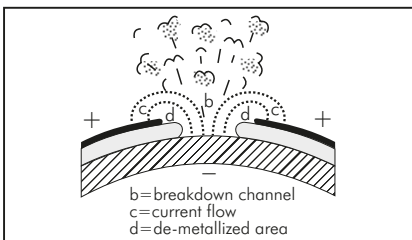

Inductance and Self-Resonance

Depending on the construction, an alternating current in the capacitor winding creates a more or less distinctive magnetic field which can be measured as inductance L . Nowadays, modern plastic film capacitors are contacted over the whole end surface of the winding element. In this way the self-inductance of the winding element is short-circuited and is reduced to the PCM (0.8 nH/mm) and the remaining length of the terminating wires (in case of SMD capacitors the distance between the soldering plates). L and C form a series oscillating circuit; at a frequency of

Old type with high self-inductance

The tape length of the winding element determines the value of the self-inductance

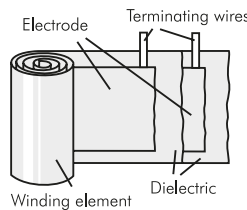

Modern WIMA type with low self-inductance

WIMA MKS 02/PCM 2.5 mm Self-inductance $L < 8$ nH
 WIMA SMD/Size Code 1812 Self-inductance $L < 6$ nH

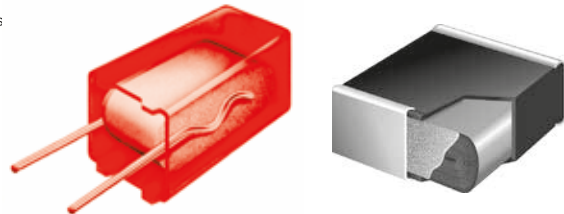

Average value for practical applications: inductance related to length = 0.8 nH/mm
 Example: length of the terminating wires = 2×3 mm + PCM.

$$f_0 = \frac{1}{2\pi \times \sqrt{L \times C}}$$

the capacitor is in self-resonance and has the lowest impedance, which only consists of r (ESR).

Dissipation Factor and ESR

The dissipation factor $\tan \delta$ is the quotient of the active and reactive components of the impedance. The losses occur mainly in the dielectric and are represented by R in the equivalent circuit diagram. Parallel to R is the insulation resistance R_{is} , which, in fact, only affects $\tan \delta$ at very low frequencies. Further dissipation is caused by the finite conductivity of the electrodes and the transfer resistance between the electrodes and the terminating wires. This is represented in the equivalent circuit diagram by the series resistance r . L represents the remaining self-inductance.

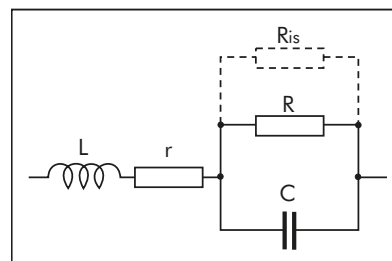

The dissipation factor is, for example, of importance for AC capacitors, which are subjected to strong currents: too high a $\tan \delta$ can lead to excessive heating brought about by the incoming active power and thus to a shorter life time of the capacitor.

Values of ESR are not directly stated in the data sheets of plastic film capacitors. The ESR for an individual capacitance value C can be calculated by the formula:

$$ESR = \tan \delta \times (2 \times \pi \times f \times C)^{-1}$$

$\tan \delta$: see data sheet of the respective WIMA type

f : frequency of the AC voltage share in the application.

ESR values for certain capacitances see characteristics of film dielectrics page 5.

Box Encapsulation

All WIMA series are produced with the proven box technology, showing the following advantages in comparison with non-encapsulated or dipped versions

- Safe protection of the capacitor element against mechanical stresses during processing and operation
- No danger of internal cracks, delamination or tearing away of the contacts due to construction elasticity
- Excellent self-healing properties of metallized capacitors due to pressure free layers in the winding element
- Solvent-resistant and flame-retardant plastic case in accordance with UL 94 V-0
- Clearly defined dimensions allows for close placement and exact setting of parts on PC-boards. Even larger parts are easily robotically insertable.

Stress Computation for WIMA Capacitors

The maximum permissible AC voltage that can be applied to capacitors in **sinusoidal** waveform applications, can be determined from the graphs in this catalogue. However, where **pulse conditions** exist, the following procedure is to be observed to ensure that the correct capacitor rating is selected for a particular duty:

1. **Rated Voltage (U_r):** The rated voltage of a capacitor against a zero potential reference point shall take into consideration that the dielectric strength of the capacitor film diminishes with rising frequency. The calculation of the required rated voltage of a capacitor must therefore allow for the correction factor k ; where k = dielectric strength of the film at the frequency f in % is shown in graph 1.

The calculation of the required dielectric strength is shown in the following example (U_{min} , U_{max} have the same polarity).

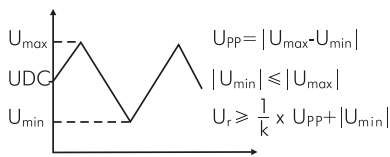

Furthermore the rms voltage derived from the peak to peak voltage shall not be greater than the nominal AC voltage rating of the capacitor to avoid the ionization inception level:
 $U_{rms} \leq U_{AC \text{ rated}}$

2. **Maximum current:** The voltage gradient or rise time of the pulse is taken as the reference point when calculating the maximum current rating of the end contacts. The maximum permissible current load on the end contacts is calculated by means of the voltage rise of the pulses (pulse rise time F_r).

$$I_{max} = F \times C \times 1.6$$

The data of the rated pulse rise time F_r for pulses equal to the rated voltage figure in the technical data of the different types.

With low voltage rise in operation (U_{pp}) the permissible current load is calculated as follows:

$$F_{max} = \frac{U_r}{U_{pp}} \times F_r$$

for example

$$U_r = 63 \text{ V}, U_{pp} = 12 \text{ V}, F_r = 50 \text{ V}/\mu\text{sec.}$$

$$\text{hence } F_{max} = \frac{63}{12} \times 50 = 262.5 \text{ V}/\mu\text{sec.}$$

When using maximum current ratings, self-heating must be taken into account at higher frequencies, and must not exceed 10 K.

3. **Dissipation (heat losses):** The heat dissipated by a capacitor when stressed by non-sinusoidal voltages or when under pulse conditions can be approximately determined from the following formula:

$$P_d = U_{rms}^2 \times \omega C \times \tan \delta \text{ where } P_d = \text{dissipation in Watts (see table 1 for the max. W per K).}$$

$$U_{rms} = \text{root mean square value of the AC voltage share.}$$

$$\omega = 2\pi \times f, \text{ where } f \text{ is the repetition frequency of the pulse waveform (C = capacitance in Farad)}$$

$$\tan \delta = \text{dissipation factor corresponding to the frequency of the steepest part of the pulse.}$$

$$\text{pulse frequency} = \frac{1}{\text{pulse width}}$$

$$\text{The temperature rise is as follows: Temperature rise in K} = \frac{\text{calculated dissipation}}{\text{specific dissipation}} \text{ (see table 1)}$$

In applications where reliability is critical, it is recommended to measure the surface temperature of the capacitor and to take into account that the temperature within the capacitor will be approximately 5 K above the case temperature.

4. **Determining the permissible AC voltage and AC current at given frequencies:**

To determine the permissible AC voltage (sinusoidal) for applications in a higher frequency spectrum, graphs showing AC voltage derating with frequency are available for the respective WIMA series.

The diagrams refer to a permissible self-heating of:

$$\Delta \theta \leq 10 \text{ K}$$

For the WIMA MKP 10/0.01 μF / 630 VDC / 400 VAC, for example, this shows – when $f = 50 \text{ kHz}$ – a permissible AC voltage of

$$U_{rms} = 280 \text{ V (graph 2)}$$

The AC voltage given in the diagrams can also be used to determine the maximum effective current.

$$X_c = \frac{1}{\omega \times C} = \frac{1}{2 \pi \times 50 \text{ kHz} \times 0.01 \mu\text{F}}$$

$$X_c = 318 \Omega$$

$$I_c = \frac{U_c}{X_c} = \frac{280 \text{ V}}{318 \Omega}$$

$$I_c = 0.88 \text{ A}$$

The calculated maximum value of the effective current

$$I_p = I_c \times \sqrt{2} = 0.88 \text{ A} \times \sqrt{2}$$

$$I_p = 1.24 \text{ A}$$

must not exceed the maximum current rating specified in the maximum pulse rise time calculation (cf. F_{max} on left). In this case, the operating AC voltage is to be reduced accordingly.

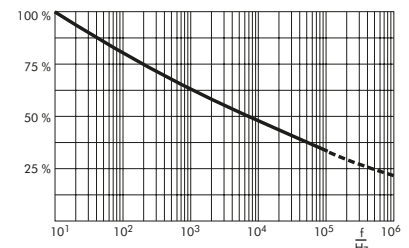

Graph 1: Dielectric strength of Polypropylene film as a factor of frequency (general guide).

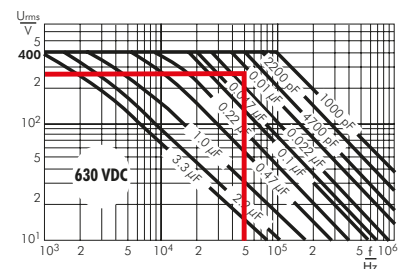

Graph 2: Permissible AC voltage in relation to frequency at 15°C internal temperature rise (general guide).

Printed circuit module PCM (in mm)	Specific dissipation in Watts per K above the ambient temperature
2.5	0.0025
5	0.004
7.5	0.006
10	0.0075
15	0.012
22.5	0.015
27.5	0.025
37.5	0.03

Table 1: The data is for ordinary assembly and ventilation conditions avoiding radiant heat within the chassis of the equipment

The Selection of Capacitors for Pulse Applications

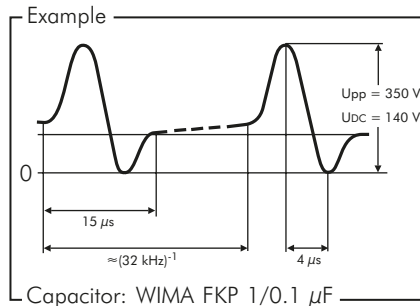

Value from table "pulse rise time WIMA FKP 1", page 81: 7000 V/ μ sec.
 The calculated voltage gradient is lower than the permissible value shown in the catalogue for this capacitor.

Dissipation

Given: $U_{rms} = 85$ V
 $f = 32$ kHz
 $C = 0.1$ μ F

The frequency determined from the steepest part of the pulse is:
 Pulse width = 15 μ sec. = 1 cycle

Hence pulse frequency =

$$\frac{1}{15 \times 10^{-6}} \approx 66 \text{ kHz}$$

The $\tan \delta$ of WIMA FKP 1 at 66 kHz $\approx 10 \times 10^{-4}$ (graph 4).
 $P_d = 85^2 \times 2 \pi \times 32 \times 10^3 \times 0.1 \times 10^{-6} \times 10 \times 10^{-4} \approx 0.145$ Watts

The selected capacitor has a pin spacing of 27.5 mm (table 1, page 11 specific dissipation = 0.025 Watts/K) and the

temperature rise due to self-heating is:

$$\text{Temperature rise} = \frac{0.145 \text{ Watts}}{0.025 \text{ Watts/K}} \approx + 6 \text{ K}$$

The temperature rise plus the max. ambient temperature \leq max. permissible operating temperature (taking into account the voltage derating factor as detailed in the Technical Data). If the permissible temperature is exceeded, please select a capacitor with a higher voltage rating.

Determination of nominal voltage

Calculation is based on an operating temperature $< +65^\circ$ C unless other data is given by the user.
 $U_r \geq 350$ V
 $U_{rms} 85$ V (referring to AC voltage share)
 Selected nominal voltage:
 400 VDC/250 VAC pin spacing 27.5 mm

Permissible voltage gradient

The voltage rise time is:
 $\frac{350 \text{ V}}{4 \mu\text{sec.}} \approx 87.5 \text{ V}/\mu\text{sec}$

Optionally a recommendation can be offered by our engineers upon receipt of voltage and current oscillogrammes.

Questionnaire available on demand.

WIMA FKP 1 Pulse Capacitors for Very High Current Ratings

The WIMA FKP1 series was developed for extremely high pulse loads. It has an internal series connection, the metal foil electrodes being combined with a floating electrode metallized on both sides. The metal foil electrodes are safely contacted on both sides of the end surfaces and allow for high current and pulse loading capabilities. At the same time the capacitor is fully self-healing due to the floating electrode metallized on both sides.

As regards pulse loading capability, WIMA FKP 1 represent the high-end of capacitor technology.

More information see page 81.

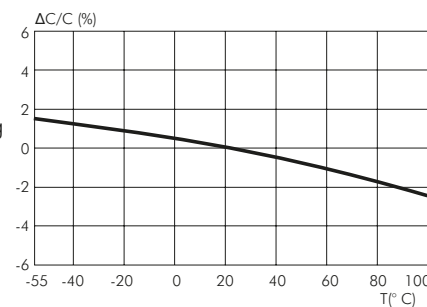

Capacitance change versus temperature (f = 1 kHz) (general guide).

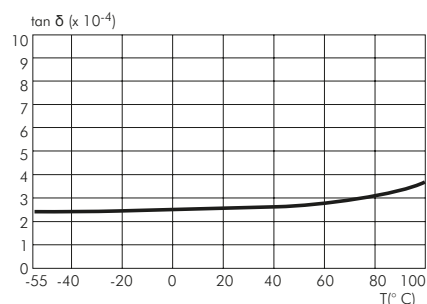

Dissipation factor change versus temperature (f = 1 kHz) (general guide).

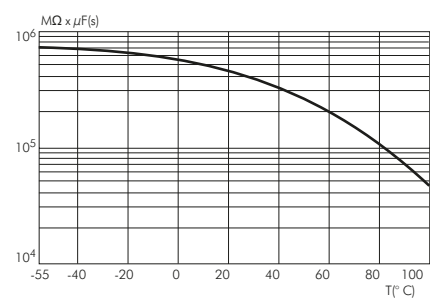

Insulation resistance change versus temperature (general guide).

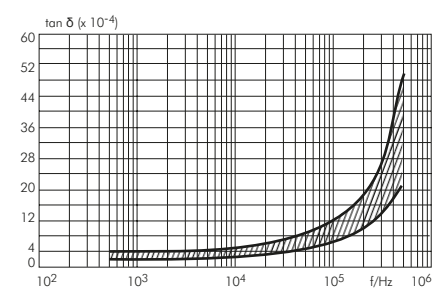

Dissipation factor change versus frequency (general guide).

Recommendation for Processing and Application of SMD Capacitors



Layout Form

The components can generally be positioned on the carrier material as desired. In order to prevent soldering shadows or ensure regular temperature distribution, extreme concentration of the components should be avoided. In practice, it has proven best to keep a minimum distance of the soldering surfaces between two WIMA SMDs of twice the height of the components.

Solder Pad Recommendation

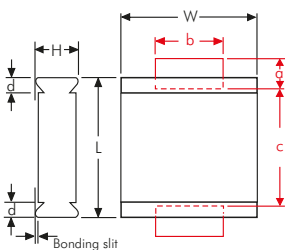

Size code	L ± 0.3	W ± 0.3	d	a min.	b min.	c max.
1812	4.8	3.3	0.5	1.2	3.5	3.5
2220	5.7	5.1	0.5	1.2	4	4.5
2824	7.2	6.1	0.5	1.2	4	6.5
4030	10.2	7.6	0.5	2.5	6	9
5040	12.7	10.2	0.7	2.5	6	11.5
6054	15.3	13.7	0.7	2.5	6	14

The solder pad size recommendations given for each individual series are to be understood as minimum dimensions which can at any time be adjusted to the layout form.

Processing

The processing of SMD components

- assembling
- soldering
- electrical final inspection/calibrating

must be regarded as a complete process. The soldering of the printed circuit board, for example, can constitute considerable stress on all the electronic components. The manufacturer's instructions on the processing of the components are mandatory.

Soldering Process

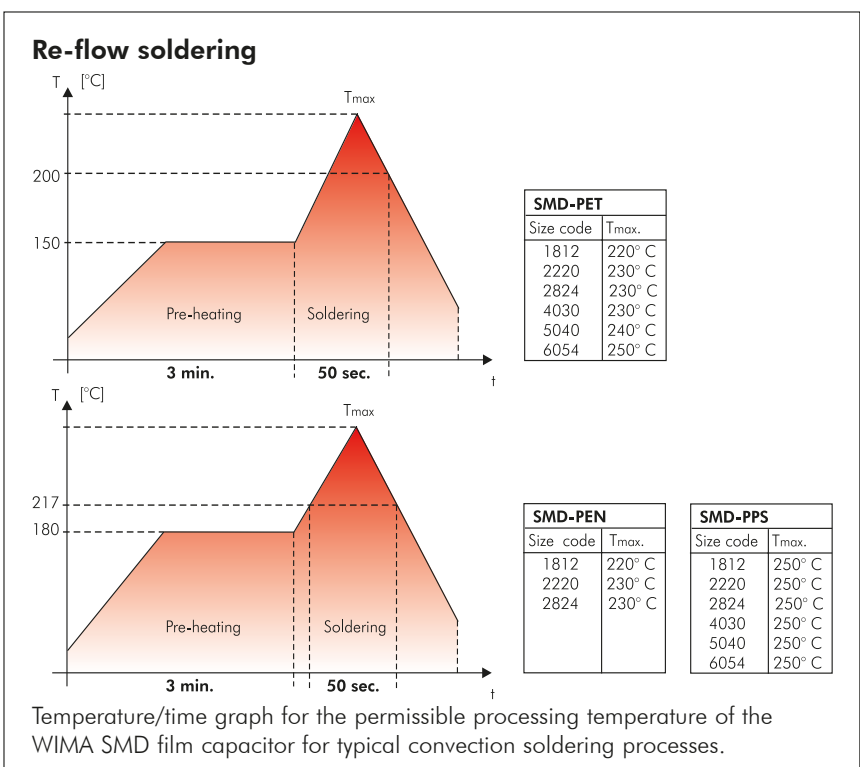

Due to versatile procedures exact processing parameters for re-flow soldering processes cannot be specified. The graph depicted is to be understood as a recommendation to help establishing a suitable soldering profile fulfilling the requirements

in practice at the user. During processing a max. temperature of $T=210^{\circ}\text{C}$ inside the component should not be exceeded. Due to the differing heat absorption the length of the soldering process should be kept as short as possible for smaller size codes.

SMD Handsoldering

WIMA SMD capacitors with plastic film dielectric are generally suitable for hand-soldering, e. g. for lab purposes, with a soldering iron where, however, similar to automated soldering processes, a certain duration and temperature should not be exceeded. These parameters are dependent on the physical size of the components and the relevant heat absorption involved.

The below data are to be regarded as guideline values and should serve to avoid damage to the dielectric caused by excessive heat during the soldering process. The soldering quality depends on the tool used and on the skill and experience of the person with the soldering iron in hand.

Size code	Temperature °C / °F	Time duration
1812	250/482	2 sec plate 1 / 5 sec off / 2 sec plate 2
2220	250/482	3 sec plate 1 / 5 sec off / 3 sec plate 2
2824	260/500	3 sec plate 1 / 5 sec off / 3 sec plate 2
4030	260/500	5 sec plate 1 / 5 sec off / 5 sec plate 2
5040	260/500	5 sec plate 1 / 5 sec off / 5 sec plate 2
6054	260/500	5 sec plate 1 / 5 sec off / 5 sec plate 2

Recommendation for Processing and Application of SMD Capacitors (Continuation)

Solder Paste

To achieve reliable soldering results one of the following solder alloys have from case to case proven being workable:

Lead free solder paste

Sn - Bi
Sn - Zn (Bi)
Sn - Ag - Cu (suitable for SMD-PET 5040/6054, SMD-PEN and SMD-PPS)

Solder paste with lead

Sn - Pb - Ag (Sn60-Pb40-A, Sn63-Pb37-A)

Washing

WIMA SMD components with plastic encapsulation - like all other components of similar construction irrespective of the make - cannot be regarded as hermetically sealed. Due to today's common washing substances, e. g. on aqueous basis instead of the formerly used halogenated hydrocarbons, with enhanced washing efficiency it became obvious that assembled SMD capacitors may show an impermissibly high deviation of the electrical parameters after a corresponding washing process. Hence it is recommended to refrain from applying industrial washing processes for WIMA SMD capacitors in order to avoid possible damages.

Initial Operation/Calibration

Due to the stress which the components are subjected to during processing, reversible parameter changes occur in almost all electronic components. The capacitance recovery accuracy to be expected with careful processing is within a scope of

$$|\Delta C/C| \leq 5 \%$$

For the initial operation of the device a minimum storage time of

$$t \geq 24 \text{ hours}$$

is to be taken into account. With calibrated devices or when the application is largely dependent on capacitance it is

advisable to prolong the storage time to

$$t \geq 10 \text{ days}$$

In this way ageing effects of the capacitor structure can be anticipated. Parameter changes due to processing are not to be expected after this period of time

Humidity Protection Bags

Taped WIMA SMD capacitors are shipped in humidity protection bags according to JEDEC standard (ESD/EMI-shield/water-vapour proof).

Under controlled conditions the components can be stored two years and more in the originally sealed bag. Opened packing units should immediately be used up for processing. If storage is necessary the opened packing units should be stored air-tight in the original plastic bag.

Reliability

Taking account of the manufacturer's guidelines and compatible processing, the WIMA SMD stand out for the same high quality and reliability as the analogous through-hole WIMA series. The technology of metallized film capacitors used e.g. in WIMA SMD-PET achieves the best values for all fields of application. The expected value is about:

$$\lambda_0 \leq 2 \text{ fit}$$

Furthermore the production of all WIMA components is subject to the regulations laid down by ISO 9001:2015 as well as the guidelines for component specifications set out by IEC quality assessment system (IECQ) for electronic components.

Electrical Characteristics and Fields of Application

Basically the WIMA SMD series have the same electrical characteristics as the analogous through-hole WIMA capacitors. Compared to ceramic or tantalum dielectrics WIMA SMD capacitors have a

number of other outstanding qualities:

- favourable pulse rise time
- low ESR
- low dielectric absorption
- available in high voltage series
- large capacitance spectrum
- stand up to high mechanical stress
- good long-term stability

As regards technical performance as well as quality and reliability, the WIMA SMD series offer the possibility to cover nearly all applications of conventionally through-hole film capacitors with SMD components. Furthermore, the WIMA SMD series can now be used for all the demanding capacitor applications for which, in the past, the use of through-hole components was mandatory:

- measuring techniques
- oscillator circuits
- differentiating and integrating circuits
- A/D or D/A transformers
- sample and hold circuits
- automotive electronics

With the WIMA SMD programme available today, the major part of all plastic film capacitors can be replaced by WIMA SMD components. The field of application ranges from standard coupling capacitors to use in switch-mode power supplies as filter or charging capacitors with high voltage and capacitance values, as well as in telecommunications e.g. the well-known telephone capacitor 1µF/250VDC.

Recommendation for Processing and Application of Through-Hole Capacitors

Soldering Process

Internal temperature of the capacitor must be kept as follows:

Polyester: preheating: $T_{max.} \leq 125^{\circ}C$
soldering: $T_{max.} \leq 135^{\circ}C$

Polypropylene: preheating: $T_{max.} \leq 100^{\circ}C$
soldering: $T_{max.} \leq 110^{\circ}C$

Single wave soldering

Soldering bath temperature: $T < 260^{\circ}C$
Dwell time: $t < 5 \text{ sec}$

Double wave soldering

Soldering bath temperature: $T < 260^{\circ}C$
Dwell time: $\sum t < 5 \text{ sec}$

Due to different soldering processes and heat requirements the graphs are to be regarded as a recommendation only.

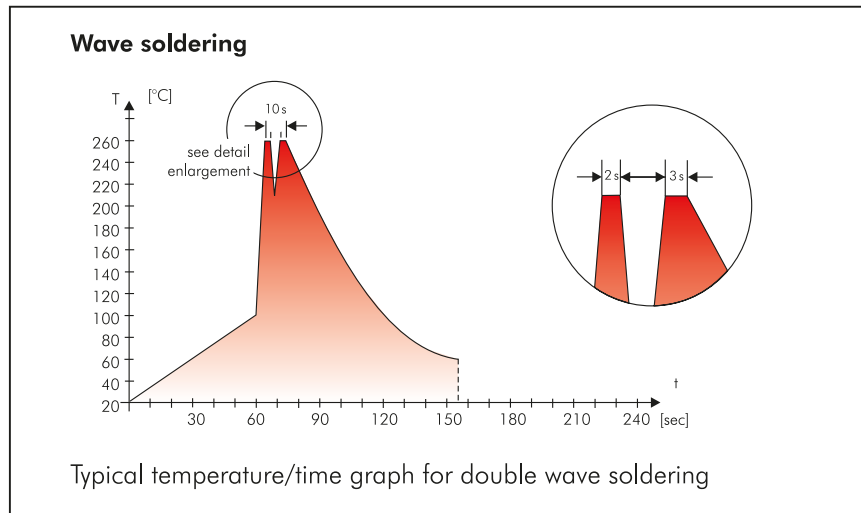

WIMA Quality and Environmental Philosophy

ISO 9001:2015 Certification

ISO 9001:2015 is an international basic standard of quality assurance systems for all branches of industry. The approval according to ISO 9001:2015 of our factories certifies that organisation, equipment and monitoring of quality assurance in our factories correspond to internationally recognized standards.

WIMA WPCS

The WIMA Process Control System (WPCS) is a quality surveillance and optimization system developed by WIMA. WPCS is a major part of the quality-oriented WIMA production. Points of application during production process:

- incoming material inspection
- metallization
- film inspection
- schoopage
- pre-healing
- pin attachment
- cast resin preparation/encapsulation
- 100% final inspection
- Testing as per customer requirements

WIMA Environmental Policy

All WIMA capacitors, irrespective of whether through-hole devices or SMD, are made of environmentally friendly materials. Neither during manufacture nor in the product itself any toxic substances are used, e.g.

- Lead
- PCB
- CFC
- Hydrocarbon chloride
- Chromium 6+
- PBB/PBDE
- Arsenic
- Cadmium
- Mercury
- etc.

We merely use pure, recyclable materials for packing our components, such as:

- carton
- cardboard
- adhesive tape made of paper
- polystyrene

We almost completely refrain from using packing materials such as:

- adhesive tapes made of plastic
- metal clips

RoHS Compliance

According to the RoHS Directive 2015/863/EU as amended from time to time certain hazardous substances like e.g. lead, cadmium, mercury must not be used any longer in electronic equipment as of July 1st, 2006. For the sake of the environment WIMA has re-frained from using such substances since years already.



WIMA Kondensatoren sind bleifrei konform RoHS 2015/863/EU

WIMA capacitors are lead free in accordance with RoHS 2015/863/EU

Tape for lead-free WIMA capacitors

DIN EN ISO 14001:2004

WIMA's environmental management has been established in accordance with the guidelines of DIN EN ISO 14001:2004 to optimize the production processes with regard to energy and resources.

WIMA SMD Capacitors in Accordance with RoHS 2015/863/EU

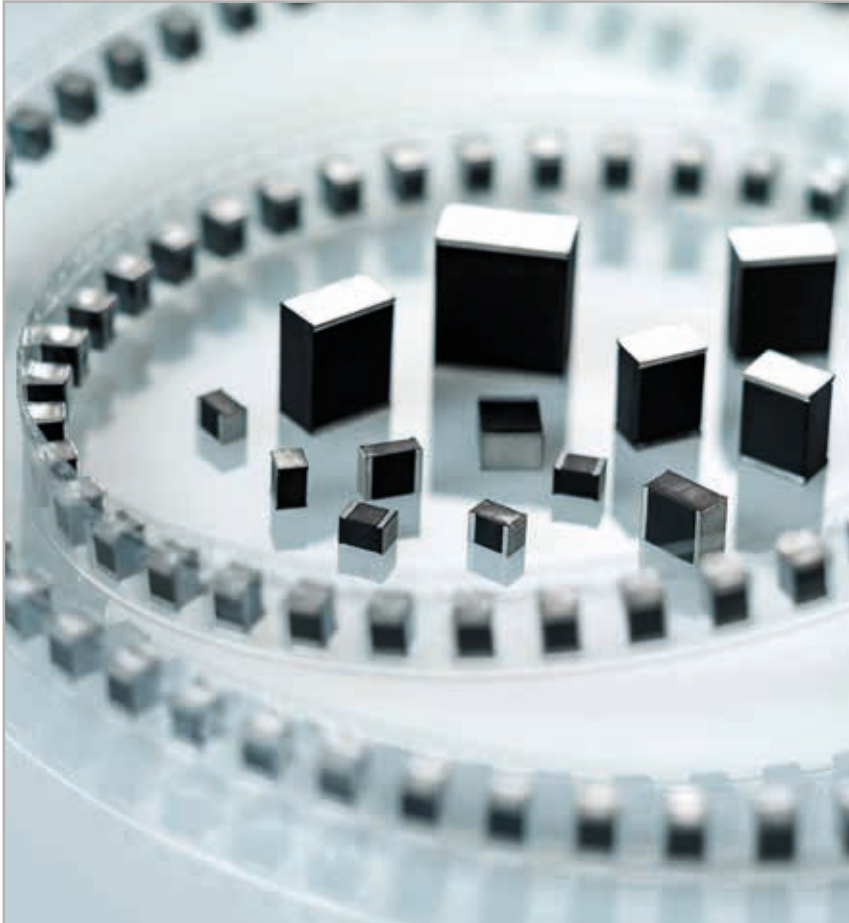

WIMA SMD-PET

WIMA SMD-PEN

WIMA SMD-PPS

WIMA SMD capacitors in size codes 1812, 2220, 2824, 4030, 5040 and 6054, capacitance values from 0.01 μF through 6.8 μF and voltage ranges of 63 VDC, 100 VDC, 250 VDC, 400 VDC, 630 VDC and 1000 VDC cover nearly the entire application range of conventional through-hole plastic film capacitors.

The WIMA SMD-PET is designed for general DC-applications e.g. coupling and decoupling, blocking, by-passing or timing and corresponds to the RoHS 2015/863/EU guidelines (Restriction of Hazardous Substances) of the EU.

The WIMA SMD-PEN is applicable for operating temperatures up to +125° C and thus suitable for lead-free solder

processes in accordance with RoHS.

The WIMA SMD-PPS has an operating temperature range up to +140° C and stands out for its stable capacitance and frequency behaviour versus temperature. Capacitors of this range are environmentally compatible with the RoHS 2015/863/EU guidelines.

All WIMA SMD series are produced with the proven box technology, showing the following advantages in comparison with non-encapsulated or moulded SMD capacitor versions:

- Safe protection of the capacitor element against mechanical and thermal stresses during processing and operation. When using more temperature resistant dielectrics like PEN or PPS an even larger safety margin than with non-encapsulated parts is obtained.
- No danger of internal cracks or tearing away of the contacts due to construction elasticity.
- No danger of delamination due to solder plates covering the capacitor's entire end surfaces.
- Solvent-resistant, flame-retardant plastic case in accordance with UL 94 V-0.

These features and the wide capacitance range enable WIMA SMDs to substitute other capacitor technologies and become standard components in electronic developments.



Metallized Polyester (PET) SMD Film Capacitors with Box Encapsulation.
Capacitances from 0.01 μF to 6.8 μF . Rated Voltages from 63 VDC to 1000 VDC.
Size Codes from 1812 to 6054.

Special Features

- Size codes 1812, 2220, 2824, 4030, 5040 and 6054 with PET and encapsulated
- Operating temperature up to 125°C
- Self-healing
- Suitable for lead-free soldering
- According to RoHS 2015/863/EU

Typical Applications

For general DC-applications e.g.

- By-pass
- Blocking
- Coupling and decoupling
- Timing

Construction

Dielectric:

Polyethylene-terephthalate (PET) film

Capacitor electrodes:

Vacuum-deposited

Internal construction:

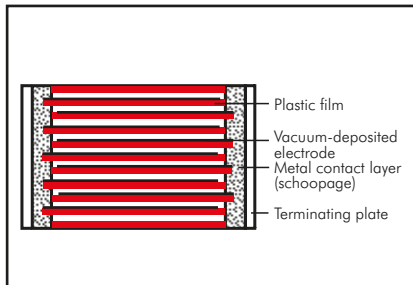

Encapsulation:

Solvent-resistant, flame-retardant plastic case, UL 94 V-0

Terminations:

Tinned plates.

Marking:

Box colour: Black.

Electrical Data

Capacitance range:

0.01 μF to 6.8 μF

Rated voltages:

63 VDC, 100 VDC, 250 VDC, 400 VDC, 630 VDC, 1000 VDC

Capacitance tolerances:

$\pm 20\%$, $\pm 10\%$ ($\pm 5\%$ available subject to special enquiry)

Operating temperature range:

-55°C to $+125^\circ\text{C}$

Climatic test category:

55/100/21 according to IEC

for size codes 1812 to 2824

55/100/56 according to IEC

for size codes 4030 to 6054

Insulation resistance at $+20^\circ\text{C}$:

U_r	U_{test}	$C \leq 0.33 \mu\text{F}$	$0.33 \mu\text{F} < C \leq 6.8 \mu\text{F}$
63 VDC 100 VDC	50 V 100 V	$\geq 3.75 \times 10^3 \text{ M}\Omega$	$\geq 1250 \text{ sec (M}\Omega \times \mu\text{F)}$
$\geq 250 \text{ VDC}$	100 V	$\geq 1 \times 10^4 \text{ M}\Omega$	$\geq 3000 \text{ sec (M}\Omega \times \mu\text{F)}$

Measuring time: 1 min.

Dissipation factors at $+20^\circ\text{C}$: $\tan \delta$

at f	$C \leq 0.1 \mu\text{F}$	$0.1 \mu\text{F} < C \leq 1.0 \mu\text{F}$	$C > 1.0 \mu\text{F}$
1 kHz	$\leq 8 \times 10^{-3}$	$\leq 8 \times 10^{-3}$	$\leq 10 \times 10^{-3}$
10 kHz	$\leq 15 \times 10^{-3}$	$\leq 15 \times 10^{-3}$	–
100 kHz	$\leq 30 \times 10^{-3}$	–	–

Maximum pulse rise time:

Capacitance μF	max. pulse rise time V/ μsec					
	63 VDC	100 VDC	250 VDC	400 VDC	630 VDC	1000 VDC
0.01 ... 0.022	30	35	40	35	40	50
0.033... 0.068	20	20	40	21	25	32
0.1 ... 0.22	10	10	12	14	17	–
0.33 ... 0.68	8	6	9	10	–	–
1.0 ... 2.2	3.5	4	7	–	–	–
3.3 ... 6.8	3	3	–	–	–	–

Dip Solder Test/Processing

Resistance to soldering heat:

Test Tb in accordance with DIN IEC 60068-2-58/DIN EN 60384-19.

Soldering bath temperature max. 260°C .

Soldering duration max. 5 sec.

Change in capacitance $\Delta C/C < 5\%$.

Soldering process:

Re-flow soldering (see temperature/time graphs page 13).

Packing

Available taped and reeled in blister pack.

Detailed taping information and graphs at the end of the catalogue.

For further details and graphs please refer to Technical Information.

Continuation

General Data

Capacitance	63 VDC/40 VAC*			100 VDC/63 VAC*			250 VDC/160 VAC*		
	Size code	H ± 0.3	Part number	Size code	H ± 0.3	Part number	Size code	H ± 0.3	Part number
0.01 µF	1812	3.0	SMDTC02100KA00	1812	3.0	SMDTD02100KA00	2220	3.5	SMDTF02100QA00
	2220	3.5	SMDTC02100QA00	2220	3.5	SMDTD02100QA00	2824	3.0	SMDTF02100TA00
	2824	3.0	SMDTC02100TA00	2824	3.0	SMDTD02100TA00			
0.015 "	1812	3.0	SMDTC02150KA00	1812	3.0	SMDTD02150KA00	2220	3.5	SMDTF02150QA00
	2220	3.5	SMDTC02150QA00	2220	3.5	SMDTD02150QA00	2824	3.0	SMDTF02150TA00
	2824	3.0	SMDTC02150TA00	2824	3.0	SMDTD02150TA00			
0.022 "	1812	3.0	SMDTC02220KA00	1812	3.0	SMDTD02220KA00	2220	3.5	SMDTF02220QA00
	2220	3.5	SMDTC02220QA00	2220	3.5	SMDTD02220QA00	2824	3.0	SMDTF02220TA00
	2824	3.0	SMDTC02220TA00	2824	3.0	SMDTD02220TA00			
0.033 "	1812	3.0	SMDTC02330KA00	1812	3.0	SMDTD02330KA00	2220	3.5	SMDTF02330QA00
	2220	3.5	SMDTC02330QA00	2220	3.5	SMDTD02330QA00	2824	3.0	SMDTF02330TA00
	2824	3.0	SMDTC02330TA00	2824	3.0	SMDTD02330TA00	4030	5.0	SMDTF02330VA00
0.047 "	1812	3.0	SMDTC02470KA00	1812	3.0	SMDTD02470KA00	2220	3.5	SMDTF02470QA00
	2220	3.5	SMDTC02470QA00	2220	3.5	SMDTD02470QA00	2824	3.0	SMDTF02470TA00
	2824	3.0	SMDTC02470TA00	2824	3.0	SMDTD02470TA00	4030	5.0	SMDTF02470VA00
0.068 "	1812	3.0	SMDTC02680KA00	1812	3.0	SMDTD02680KA00	2220	4.5	SMDTF02680QB00
	2220	3.5	SMDTC02680QA00	2220	3.5	SMDTD02680QA00	2824	3.0	SMDTF02680TA00
	2824	3.0	SMDTC02680TA00	2824	3.0	SMDTD02680TA00	4030	5.0	SMDTF02680VA00
0.1 µF	1812	4.0	SMDTC03100KB00	1812	4.0	SMDTD03100KB00	2220	4.5*	SMDTF03100QB00
	2220	3.5	SMDTC03100QA00	2220	3.5	SMDTD03100QA00	2824	5.0	SMDTF03100TB00
	2824	3.0	SMDTC03100TA00	2824	3.0	SMDTD03100TA00	4030	5.0	SMDTF03100VA00
0.15 "	1812	4.0	SMDTC03150KB00	1812	4.0	SMDTD03150KB00	2824	5.0	SMDTF03150TB00
	2220	3.5	SMDTC03150QA00	2220	3.5	SMDTD03150QA00	4030	5.0	SMDTF03150VA00
	2824	3.0	SMDTC03150TA00	2824	3.0	SMDTD03150TA00			
0.22 "	1812	4.0	SMDTC03220KB00	1812	4.0	SMDTD03220KB00	2824	5.0	SMDTF03220TB00
	2220	3.5	SMDTC03220QA00	2220	3.5	SMDTD03220QA00	4030	5.0	SMDTF03220VA00
	2824	3.0	SMDTC03220TA00	2824	3.0	SMDTD03220TA00			
0.33 "	1812	4.0	SMDTC03330KB00	2220	4.5	SMDTD03330QB00	2824	5.0	SMDTF03330TB00
	2220	4.5	SMDTC03330QB00	2824	5.0	SMDTD03330TB00	4030	5.0	SMDTF03330VA00
	2824	5.0	SMDTC03330TB00	4030	5.0	SMDTD03330VA00	5040	6.0	SMDTF03330XA00
0.47 "	1812	4.0	SMDTC03470KB00	2220	4.5	SMDTD03470QB00	4030	5.0	SMDTF03470VA00
	2220	4.5	SMDTC03470QB00	2824	5.0	SMDTD03470TB00	5040	6.0	SMDTF03470XA00
	2824	5.0	SMDTC03470TB00	4030	5.0	SMDTD03470VA00			
0.68 "	2220	4.5	SMDTC03680QB00	2824	5.0	SMDTD03680TB00	5040	6.0	SMDTF03680XA00
	2824	5.0	SMDTC03680TB00	4030	5.0	SMDTD03680VA00			
	4030	5.0	SMDTC03680VA00	5040	6.0	SMDTD03680XA00			
1.0 µF	2220	4.5	SMDTC04100QB00	2824	5.0	SMDTD04100TB00	6054	7.0	SMDTF04100YA00
	2824	5.0	SMDTC04100TB00	4030	5.0	SMDTD04100VA00			
	4030	5.0	SMDTC04100VA00	5040	6.0	SMDTD04100XA00			
1.5 "	2824	5.0	SMDTC04150TB00	4030	5.0	SMDTD04150VA00			
	4030	5.0	SMDTC04150VA00	5040	6.0	SMDTD04150XA00			
2.2 "	2824	5.0	SMDTC04220TB00	5040	6.0	SMDTD04220XA00			
	4030	5.0	SMDTC04220VA00						
3.3 "	4030	5.0	SMDTC04330VA00	5040	6.0	SMDTD04330XA00			
4.7 "	5040	6.0	SMDTC04470XA00	6054	7.0	SMDTD04470YA00			
6.8 "	6054	7.0	SMDTC04680YA00						

Part number completion:	
Tolerance:	20 % = M
	10 % = K
	5 % = J
Packing:	bulk = S
Pin length:	none = 00
Taped version see page 156.	

* AC voltage: $f = 50 \text{ Hz}$; $1.4 \times U_{\text{rms}} + U_{\text{DC}} \leq U_r$

Dims. in mm.

Rights reserved to amend design data without prior notification.

Continuation

General Data

Capacitance	400 VDC/200 VAC*			630 VDC/300 VAC*			1000 VDC/400 VAC*		
	Size code	H ±0.3	Part number	Size code	H ±0.3	Part number	Size code	H ±0.3	Part number
0.01 µF	2824 4030	3.0 5.0	SMDTG02100TA00____ SMDTG02100VA00____	4030	5.0	SMDTJ02100VA00____			
0.015 "	2824 4030	3.0 5.0	SMDTG02150TA00____ SMDTG02150VA00____	4030	5.0	SMDTJ02150VA00____	5040	6.0	SMDTO12150XA00____
0.022 "	2824 4030	5.0 5.0	SMDTG02220TB00____ SMDTG02220VA00____	5040	6.0	SMDTJ02220XA00____	5040	6.0	SMDTO12220XA00____
0.033 "	2824 4030	5.0 5.0	SMDTG02330TB00____ SMDTG02330VA00____	5040	6.0	SMDTJ02330XA00____	5040	6.0	SMDTO12330XA00____
0.047 "	2824 4030	5.0 5.0	SMDTG02470TB00____ SMDTG02470VA00____	5040	6.0	SMDTJ02470XA00____	6054	7.0	SMDTO12470YA00____
0.068 "	4030 5040	5.0 6.0	SMDTG02680VA00____ SMDTG02680XA00____	5040	6.0	SMDTJ02680XA00____			
0.1 µF	4030 5040	5.0 6.0	SMDTG03100VA00____ SMDTG03100XA00____	6054	7.0	SMDTJ03100YA00____			
0.15 "	4030 5040	5.0 6.0	SMDTG03150VA00____ SMDTG03150XA00____	6054	7.0	SMDTJ03150YA00____			
0.22 "	5040	6.0	SMDTG03220XA00____	6054	7.0	SMDTJ03220YA00____			
0.33 "	5040	6.0	SMDTG03330XA00____						
0.47 "	6054	7.0	SMDTG03470YA00____						

* AC voltage: $f = 50 \text{ Hz}$; $1.4 \times U_{\text{rms}} + \text{UDC} \leq U_r$

Solder pad recommendation

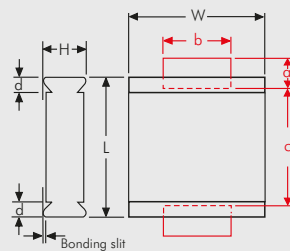

Dims. in mm.

Part number completion:

Tolerance: 20 % = M
10 % = K
5 % = J
Packing: bulk = S
Pin length: none = 00
Taped version see page 156.

Size code	L ±0.3	W ±0.3	d	a min.	b min.	c max.
1812	4.8	3.3	0.5	1.2	3.5	3.5
2220	5.7	5.1	0.5	1.2	4	4.5
2824	7.2	6.1	0.5	1.2	4	6.5
4030	10.2	7.6	0.5	2.5	6	9
5040	12.7	10.2	0.7	2.5	6	11.5
6054	15.3	13.7	0.7	2.5	6	14

Rights reserved to amend design data without prior notification.

Continuation

Impedance change with frequency (general guide).

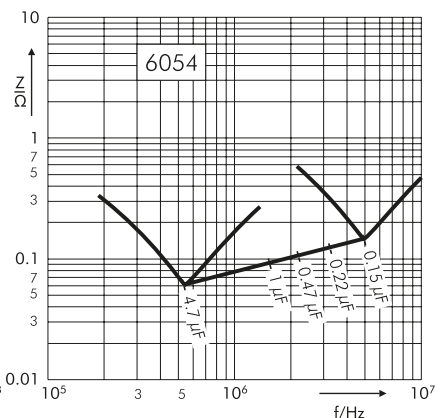
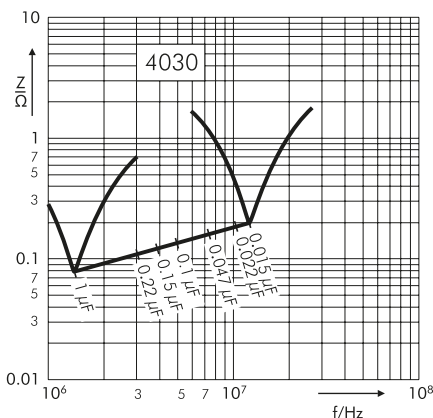
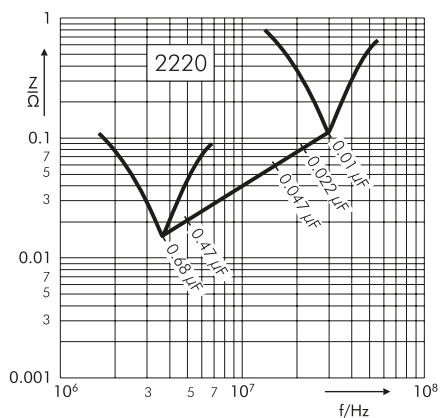
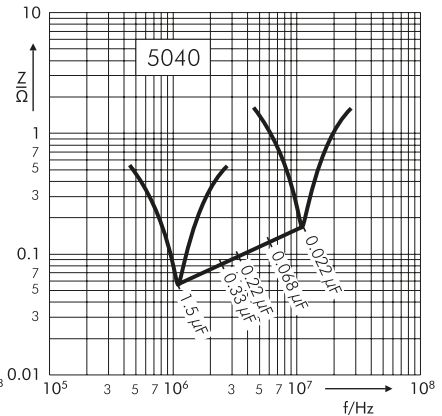
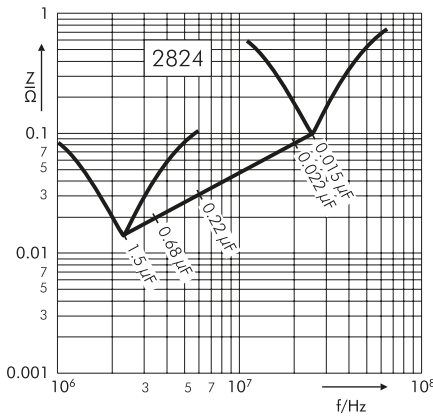
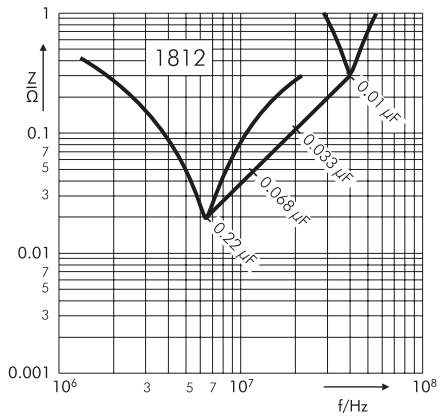

Permissible AC voltage in relation to frequency at 10° C internal temperature rise (general guide).

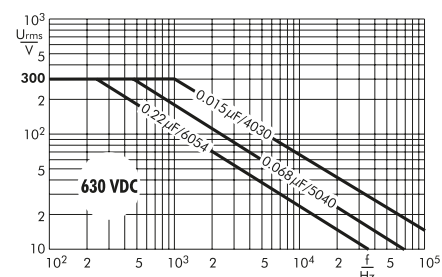
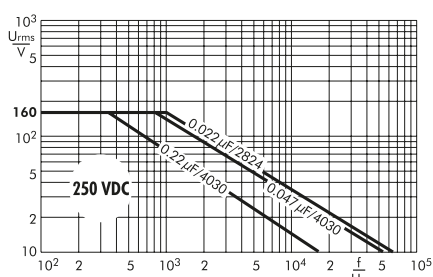
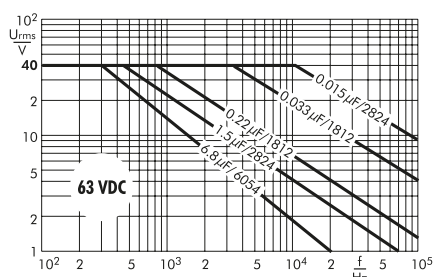
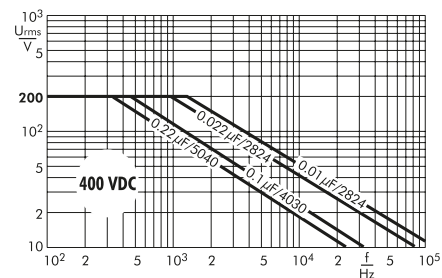
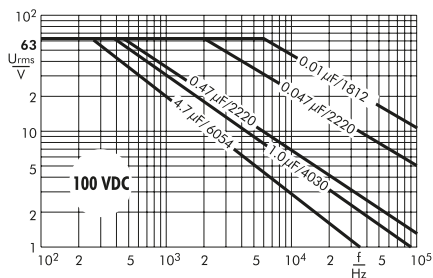

Metallized Polyethylene-Naphthalate (PEN) SMD Film Capacitors with Box Encapsulation. Capacitances from 0.01 μF to 1.0 μF . Rated Voltages from 63 VDC to 400 VDC. Size Codes from 1812 to 2824.

Special Features

- Size codes 1812, 2220 and 824, with PEN and encapsulated
- Operating temperature up to 125° C
- Self-healing
- Suitable for lead-free soldering
- According to RoHS 2015/863/EU

Typical Applications

For general DC-applications e.g.

- By-pass
- Blocking
- Coupling and decoupling
- Timing

Construction

Dielectric:

Polyethylene-Naphthalate (PEN) film

Capacitor electrodes:

Vacuum-deposited

Internal construction:

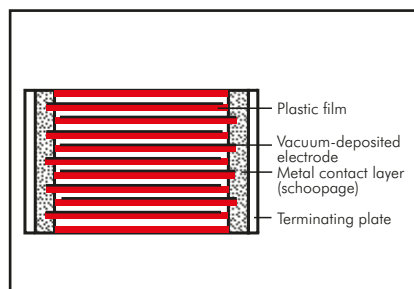

Encapsulation:

Solvent-resistant, flame-retardant plastic case, UL 94 V-0

Terminations:

Tinned plates.

Marking:

Colour: Black.

Electrical Data

Capacitance range:

0.01 μF to 1.0 μF

Rated voltages:

63 VDC, 100 VDC, 250 VDC, 400 VDC

Capacitance tolerances:

$\pm 20\%$, $\pm 10\%$ ($\pm 5\%$ available subject to special enquiry)

Operating temperature range:

-55°C to $+125^\circ\text{C}$

Climatic test category:

55/125/21 according to IEC

Insulation resistance at $+20^\circ\text{C}$:

U_r	U_{test}	$C \leq 0.33 \mu\text{F}$	$0.33 \mu\text{F} < C \leq 1.0 \mu\text{F}$
63 VDC 100 VDC	50 V 100 V	$\geq 3.75 \times 10^3 \text{ M}\Omega$	$\geq 1250 \text{ sec (M}\Omega \times \mu\text{F)}$
$\geq 250 \text{ VDC}$	100 V	$\geq 1 \times 10^4 \text{ M}\Omega$	$\geq 3000 \text{ sec (M}\Omega \times \mu\text{F)}$

Measuring time: 1 min.

Dissipation factors at $+20^\circ\text{C}$: $\tan \delta$

at f	$C \leq 0.1 \mu\text{F}$	$0.1 \mu\text{F} < C \leq 1.0 \mu\text{F}$
1 kHz	$\leq 8 \times 10^{-3}$	$\leq 8 \times 10^{-3}$
10 kHz	$\leq 15 \times 10^{-3}$	$\leq 15 \times 10^{-3}$
100 kHz	$\leq 30 \times 10^{-3}$	–

Maximum pulse rise time:

Capacitance μF	max. pulse rise time V/ μsec			
	63 VDC	100 VDC	250 VDC	400 VDC
0.01 ...0.022	30	35	40	35
0.033...0.068	20	20	40	21
0.1 ...0.22	10	10	12	–
0.33 ...0.68	8	6	–	–
1.0	3.5	4	–	–

Dip Solder Test/Processing

Resistance to soldering heat:

Test Tb in accordance with DIN IEC 60068-2-58/DIN EN 60384-23.

Soldering bath temperature max. 260° C.

Soldering duration max. 5 sec.

Change in capacitance $\Delta C/C < 5\%$.

Soldering process:

Re-flow soldering (see temperature/time graphs page 13).

Packing

Available taped and reeled in blister pack.

Detailed taping information and graphs at the end of the catalogue.

For further details and graphs please refer to Technical Information.

Continuation

General Data

Capacitance	63 VDC/40 VAC*			100 VDC/63 VAC*		
	Size code	H ± 0.3	Part number	Size code	H ± 0.3	Part number
0.01 µF	1812	3.0	SMDNC02100KA00_	1812	3.0	SMDND02100KA00_
	2220	3.5	SMDNC02100QA00_	2220	3.5	SMDND02100QA00_
	2824	3.0	SMDNC02100TA00_	2824	3.0	SMDND02100TA00_
0.015 "	1812	3.0	SMDNC02150KA00_	1812	3.0	SMDND02150KA00_
	2220	3.5	SMDNC02150QA00_	2220	3.5	SMDND02150QA00_
	2824	3.0	SMDNC02150TA00_	2824	3.0	SMDND02150TA00_
0.022 "	1812	3.0	SMDNC02220KA00_	1812	3.0	SMDND02220KA00_
	2220	3.5	SMDNC02220QA00_	2220	3.5	SMDND02220QA00_
	2824	3.0	SMDNC02220TA00_	2824	3.0	SMDND02220TA00_
0.033 "	1812	3.0	SMDNC02330KA00_	1812	3.0	SMDND02330KA00_
	2220	3.5	SMDNC02330QA00_	2220	3.5	SMDND02330QA00_
	2824	3.0	SMDNC02330TA00_	2824	3.0	SMDND02330TA00_
0.047 "	1812	3.0	SMDNC02470KA00_	1812	3.0	SMDND02470KA00_
	2220	3.5	SMDNC02470QA00_	2220	3.5	SMDND02470QA00_
	2824	3.0	SMDNC02470TA00_	2824	3.0	SMDND02470TA00_
0.068 "	1812	3.0	SMDNC02680KA00_	1812	3.0	SMDND02680KA00_
	2220	3.5	SMDNC02680QA00_	2220	3.5	SMDND02680QA00_
	2824	3.0	SMDNC02680TA00_	2824	3.0	SMDND02680TA00_
0.1 µF	1812	4.0	SMDNC03100KB00_	1812	4.0	SMDND03100KB00_
	2220	3.5	SMDNC03100QA00_	2220	3.5	SMDND03100QA00_
	2824	3.0	SMDNC03100TA00_	2824	3.0	SMDND03100TA00_
0.15 "	1812	4.0	SMDNC03150KB00_	1812	4.0	SMDND03150KB00_
	2220	3.5	SMDNC03150QA00_	2220	3.5	SMDND03150QA00_
	2824	3.0	SMDNC03150TA00_	2824	3.0	SMDND03150TA00_
0.22 "	2220	3.5	SMDNC03220QA00_	2220	3.5	SMDND03220QA00_
	2824	3.0	SMDNC03220TA00_	2824	3.0	SMDND03220TA00_
0.33 "	2220	4.5	SMDNC03330QB00_	2220	4.5	SMDND03330QB00_
	2824	5.0	SMDNC03330TB00_	2824	5.0	SMDND03330TB00_
0.47 "	2220	4.5	SMDNC03470QB00_	2220	4.5	SMDND03470QB00_
	2824	5.0	SMDNC03470TB00_	2824	5.0	SMDND03470TB00_
0.68 "	2824	5.0	SMDNC03680TB00_	2824	5.0	SMDND03680TB00_
1.0 µF	2824	5.0	SMDNC04100TB00_	2824	5.0	SMDND04100TB00_

* AC voltage: $f = 50 \text{ Hz}$; $1.4 \times U_{\text{rms}} + \text{UDC} \leq U_r$

Dims in mm.

Part number completion:

Tolerance: 20 % = M
 10 % = K
 5 % = J
 Packing: bulk = S
 Pin length: none = 00
 Taped version see page 156.

Rights reserved to amend design data without prior notification.

Continuation page 23

Continuation

General Data

Capacitance	250 VDC/160 VAC*			400 VDC/200 VAC*		
	Size code	H ± 0.3	Part number	Size code	H ± 0.3	Part number
0.01 µF	2220 2824	3.5 3.0	SMDNF02100QA00____ SMDNF02100TA00____	2824	3.0	SMDNG02100TA00____
0.015 „	2220 2824	3.5 3.0	SMDNF02150QA00____ SMDNF02150TA00____	2824	3.0	SMDNG02150TA00____
0.022 „	2220 2824	3.5 3.0	SMDNF02220QA00____ SMDNF02220TA00____	2824	5.0	SMDNG02220TB00____
0.033 „	2220 2824	3.5 3.0	SMDNF02330QA00____ SMDNF02330TA00____	2824	5.0	SMDNG02330TB00____
0.047 „	2220 2824	3.5 3.0	SMDNF02470QA00____ SMDNF02470TA00____	2824	5.0	SMDNG02470TB00____
0.068 „	2220 2824	4.5 3.0	SMDNF02680QB00____ SMDNF02680TA00____			
0.1 µF	2220 2824	4.5 5.0	SMDNF03100QB00____ SMDNF03100TB00____			
0.15 „	2824	5.0	SMDNF03150TB00____			

* AC voltage: $f = 50 \text{ Hz}$; $1.4 \times U_{\text{rms}} + \text{UDC} \leq U_r$

Dims in mm.

Solder pad recommendation

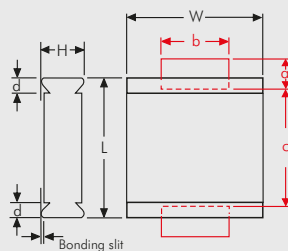

Part number completion:	
Tolerance:	20 % = M 10 % = K 5 % = J
Packing:	bulk = S
Pin length:	none = 00
Taped version see page 156.	

Size code	L ±0.3	W ±0.3	d	a min.	b min.	c max.
1812	4.8	3.3	0.5	1.2	3.5	3.5
2220	5.7	5.1	0.5	1.2	4	4.5
2824	7.2	6.1	0.5	1.2	4	6.5

Rights reserved to amend design data without prior notification.

Continuation page 24

Continuation

Impedance change with frequency
(general guide).

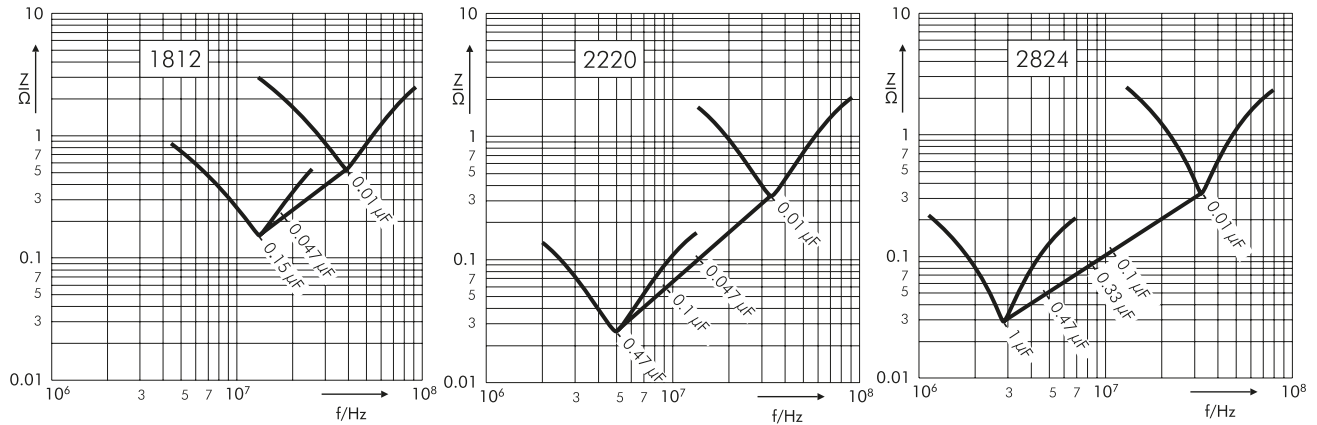

Permissible AC voltage in relation to frequency at 10° C internal temperature rise
(general guide).

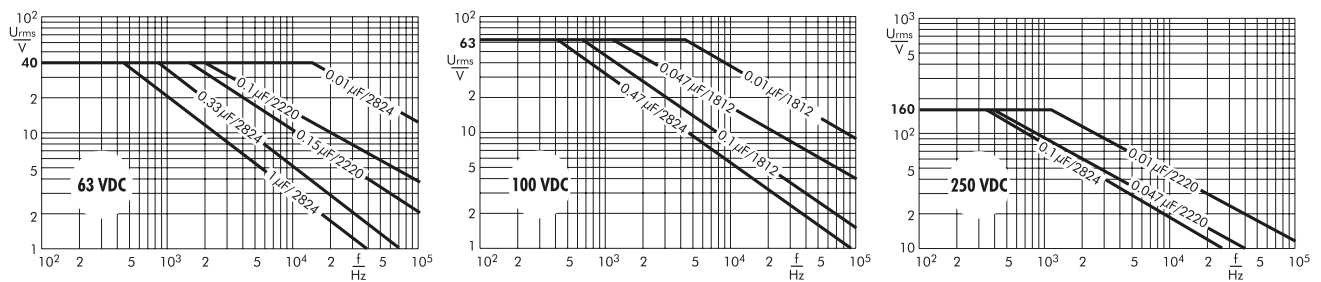

Metallized Polyphenylene-Sulphide (PPS) SMD Film Capacitors with Box Encapsulation. Capacitances from 0.01 μF to 2.2 μF . Rated Voltages from 63 VDC to 1000 VDC. Size Codes from 1812 to 6054.

Special Features

- Size codes 1812, 2220, 2824, 4030, 5040 and 6054 with PPS and encapsulated
- Operating temperature up to 140°C
- Self-healing
- Suitable for lead-free soldering
- Low dissipation factor
- Low dielectric absorption
- Very constant capacitance value versus temperature
- According to RoHS 2015/863/EU

Typical Applications

For general applications in high temperature circuits e.g.

- By-pass
- Blocking
- Coupling and decoupling
- Timing
- Filtering
- Oscillating circuits

Construction

Dielectric:

Polyphenylene-sulphide (PPS) film

Capacitor electrodes:

Vacuum-deposited

Internal construction:

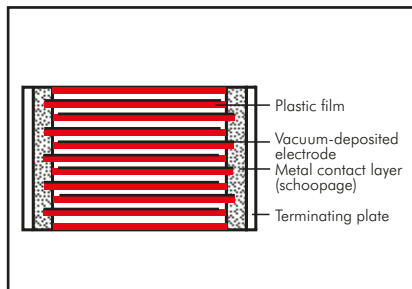

Encapsulation:

Solvent-resistant, flame-retardant plastic case, UL 94 V-0

Terminations:

Tinned plates.

Marking:

Box colour: Black.

Electrical Data

Capacitance range: 0.01 μF to 2.2 μF

Rated voltages:

63 VDC, 100 VDC, 250 VDC, 400 VDC, 630 VDC, 1000 VDC

Capacitance tolerances:

$\pm 20\%$, $\pm 10\%$ ($\pm 5\%$ available subject to special enquiry)

Operating temperature range:

-55°C to $+140^\circ\text{C}$

Climatic test category:

55/140/56 in accordance with IEC

Insulation resistance at $+20^\circ\text{C}$:

U_r	U_{test}	$C \leq 0.33 \mu\text{F}$	$0.33 \mu\text{F} < C \leq 2.2 \mu\text{F}$
63 VDC 100 VDC	50 V 100 V	$\geq 1 \times 10^4 \text{ M}\Omega$	$\geq 3000 \text{ sec (M}\Omega \times \mu\text{F)}$
$\geq 250 \text{ VDC}$	100 V	$\geq 3 \times 10^4 \text{ M}\Omega$	$\geq 6000 \text{ sec (M}\Omega \times \mu\text{F)}$

Measuring time: 1 min.

Dissipation factors at $+20^\circ\text{C}$: $\tan \delta$

at f	$C \leq 0.1 \mu\text{F}$	$0.1 \mu\text{F} < C \leq 1.0 \mu\text{F}$	$C > 1.0 \mu\text{F}$
1 kHz	$\leq 15 \times 10^{-4}$	$\leq 20 \times 10^{-4}$	$\leq 20 \times 10^{-4}$
10 kHz	$\leq 25 \times 10^{-4}$	$\leq 25 \times 10^{-4}$	–
100 kHz	$\leq 50 \times 10^{-4}$	–	–

Maximum pulse rise time:

Capacitance μF	max. pulse rise time V/ μsec					
	63 VDC	100 VDC	250 VDC	400 VDC	630 VDC	1000 VDC
0.01 ... 0.022	25	25	30	35	40	45
0.033... 0.068	15	15	20	25	28	32
0.1 ... 0.22	10	10	12	15	–	–
0.33 ... 0.68	5	5	6	8	–	–
1.0 ... 2.2	3	3	–	–	–	–

Dip Solder Test/Processing

Resistance to soldering heat:

Test Tb in accordance with DIN IEC 60068-2-58/DIN EN 60384-20.

Soldering bath temperature max. 260°C.

Soldering duration max. 5 sec.

Change in capacitance $\Delta C/C < 5\%$.

Soldering process:

Re-flow soldering (see temperature/time graphs page 13).

Packing

Available taped and reeled in blister pack.

Detailed taping information and graphs at the end of the catalogue.

For further details and graphs please refer to Technical Information.

Continuation

General Data

Capacitance	63 VDC/40 VAC*			100 VDC/63 VAC*			250 VDC/160 VAC*		
	Size code	H ±0.3	Part number	Size code	H ±0.3	Part number	Size code	H ±0.3	Part number
0.01 µF	1812	3.0	SMDIC02100KA00	1812	3.0	SMDID02100KA00	2220	3.5	SMDIF02100QA00
	2220	3.5	SMDIC02100QA00	2220	3.5	SMDID02100QA00			
0.015 "	1812	3.0	SMDIC02150KA00	1812	3.0	SMDID02150KA00	2220	3.5	SMDIF02150QA00
	2220	3.5	SMDIC02150QA00	2220	3.5	SMDID02150QA00			
0.022 "	1812	3.0	SMDIC02220KA00	1812	3.0	SMDID02220KA00	2220	3.5	SMDIF02220QA00
	2220	3.5	SMDIC02220QA00	2220	3.5	SMDID02220QA00	2824	3.0	SMDIF02220TA00
0.033 "	1812	3.0	SMDIC02330KA00	1812	3.0	SMDID02330KA00	2824	3.0	SMDIF02330TA00
	2220	3.5	SMDIC02330QA00	2220	3.5	SMDID02330QA00	4030	5.0	SMDIF02330VA00
	2824	3.0	SMDIC02330TA00	2824	3.0	SMDID02330TA00			
0.047 "	1812	3.0	SMDIC02470KA00	1812	3.0	SMDID02470KA00	2824	5.0	SMDIF02470TB00
	2220	3.5	SMDIC02470QA00	2220	3.5	SMDID02470QA00	4030	5.0	SMDIF02470VA00
	2824	3.0	SMDIC02470TA00	2824	3.0	SMDID02470TA00			
0.068 "	1812	3.0	SMDIC02680KA00	2220	3.5	SMDID02680QA00	2824	5.0	SMDIF02680TB00
	2220	3.5	SMDIC02680QA00	2824	3.0	SMDID02680TA00	4030	5.0	SMDIF02680VA00
	2824	3.0	SMDIC02680TA00						
0.1 µF	1812	3.0	SMDIC03100KA00	2220	3.5	SMDID03100QA00	2824	5.0	SMDIF03100TB00
	2220	3.5	SMDIC03100QA00	2824	3.0	SMDID03100TA00	4030	5.0	SMDIF03100VA00
	2824	3.0	SMDIC03100TA00				5040	6.0	SMDIF03100XA00
0.15 "	1812	4.0	SMDIC03150KB00	2824	3.0	SMDID03150TA00	4030	5.0	SMDIF03150VA00
	2220	3.5	SMDIC03150QA00				5040	6.0	SMDIF03150XA00
	2824	3.0	SMDIC03150TA00				6054	7.0	SMDIF03150YA00
0.22 "	2220	4.5	SMDIC03220QB00	2220	4.5	SMDID03220QB00	4030	5.0	SMDIF03220VA00
	2824	5.0	SMDIC03220TB00	2824	5.0	SMDID03220TB00	5040	6.0	SMDIF03220XA00
							6054	7.0	SMDIF03220YA00
0.33 "	2220	4.5	SMDIC03330QB00	2824	5.0	SMDID03330TB00	5040	6.0	SMDIF03330XA00
	2824	5.0	SMDIC03330TB00	4030	5.0	SMDID03330VA00	6054	7.0	SMDIF03330YA00
	4030	5.0	SMDIC03330VA00						
0.47 "	2220	4.5	SMDIC03470QB00	2824	5.0	SMDID03470TB00	6054	7.0	SMDIF03470YA00
	2824	5.0	SMDIC03470TB00	4030	5.0	SMDID03470VA00			
	4030	5.0	SMDIC03470VA00						
0.68 "	2824	5.0	SMDIC03680TB00	4030	5.0	SMDID03680VA00			
	4030	5.0	SMDIC03680VA00						
1.0 µF	2824	5.0	SMDIC04100TB00	5040	6.0	SMDID04100XA00			
	4030	5.0	SMDIC04100VA00						
	5040	6.0	SMDIC04100XA00						
1.5 "	4030	5.0	SMDIC04150VA00	6054	7.0	SMDID04150YA00			
	5040	6.0	SMDIC04150XA00						
2.2 "	6054	7.0	SMDIC04220YA00	6054	7.0	SMDID04220YA00			

Part number completion:	
Tolerance:	20 % = M
	10 % = K
	5 % = J
Packing:	bulk = S
Pin length:	none = 00
Taped version see page 156.	

* AC voltages: $f \leq 400$ Hz; $1.4 \times U_{rms} + U_{DC} \leq U_r$

Dims. in mm.

Rights reserved to amend design data without prior notification.

Continuation page 27

Continuation

General Data

Capacitance	400 VDC/200 VAC*			630 VDC/300 VAC*			1000 VDC/400 VAC*		
	Size code	H ±0.3	Part number	Size code	H ±0.3	Part number	Size code	H ±0.3	Part number
0.01 µF				5040	6.0	SMDIJ02100XA00_____	5040	6.0	SMDIO12100XA00_____
0.015 "				5040	6.0	SMDIJ02150XA00_____	5040	6.0	SMDIO12150XA00_____
0.022 "	4030 5040	5.0 6.0	SMDIG02220YA00_____ SMDIG02220XA00_____	5040	6.0	SMDIJ02220XA00_____	6054	7.0	SMDIO12220YA00_____
0.033 "	4030 5040	5.0 6.0	SMDIG02330YA00_____ SMDIG02330XA00_____	5040	6.0	SMDIJ02330XA00_____	6054	7.0	SMDIO12330YA00_____
0.047 "	4030 5040	5.0 6.0	SMDIG02470YA00_____ SMDIG02470XA00_____	5040	6.0	SMDIJ02470XA00_____			
0.068 "	4030 5040	5.0 6.0	SMDIG02680YA00_____ SMDIG02680XA00_____	6054	7.0	SMDIJ02680YA00_____			
0.1 µF	4030 5040 6054	5.0 6.0 7.0	SMDIG03100YA00_____ SMDIG03100XA00_____ SMDIG03100YA00_____						
0.15 "	5040 6054	6.0 7.0	SMDIG03150XA00_____ SMDIG03150YA00_____						
0.22 "	6054	7.0	SMDIG03220YA00_____						
0.33 "	6054	7.0	SMDIG03330YA00_____						

* AC voltages: $f \leq 400$ Hz; $1.4 \times U_{rms} + UDC \leq U_r$

Dims. in mm.

Solder pad recommendation

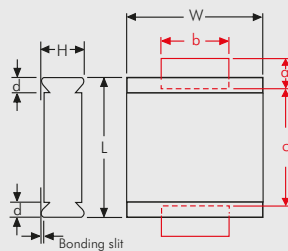

Part number completion:	
Tolerance:	20 % = M
	10 % = K
	5 % = J
Packing:	bulk = S
Pin length:	none = 00
Taped version see page 156.	

Size code	L ±0.3	W ±0.3	d	a min.	b min.	c max.
1812	4.8	3.3	0.5	1.2	3.5	3.5
2220	5.7	5.1	0.5	1.2	4	4.5
2824	7.2	6.1	0.5	1.2	4	6.5
4030	10.2	7.6	0.5	2.5	6	9
5040	12.7	10.2	0.7	2.5	6	11.5
6054	15.3	13.7	0.7	2.5	6	14

Rights reserved to amend design data without prior notification.

Continuation page 28

Continuation

Impedance change with frequency
(general guide).

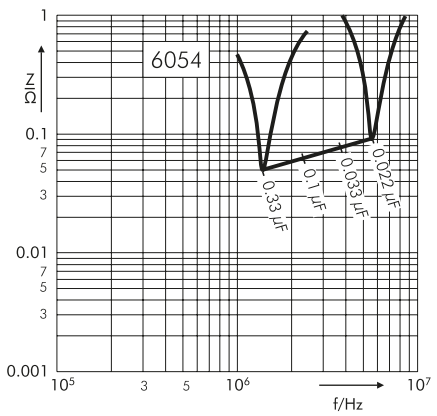
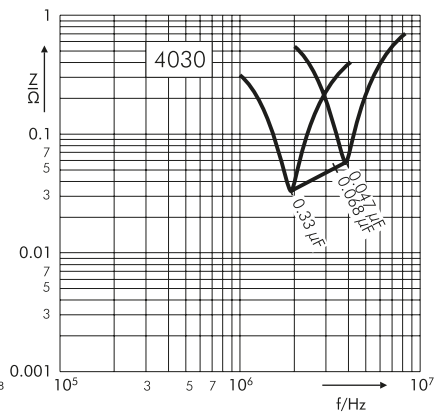
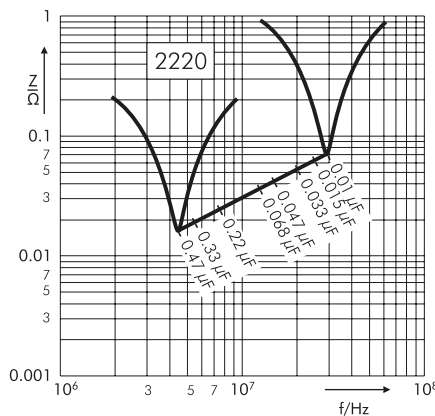
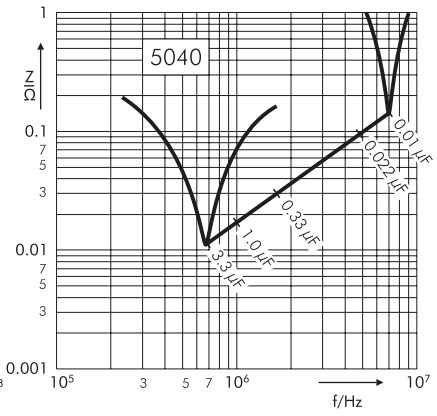
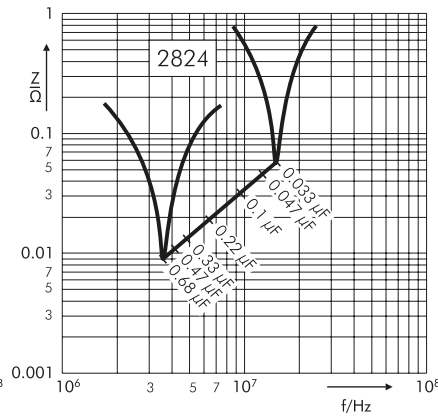
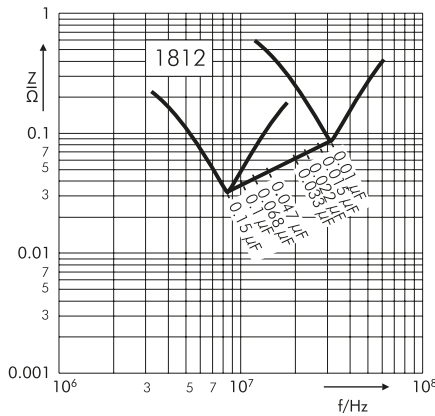

Permissible AC voltage in relation to
frequency at 10° C internal temperature
rise (general guide).

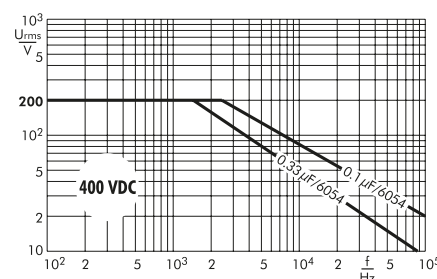
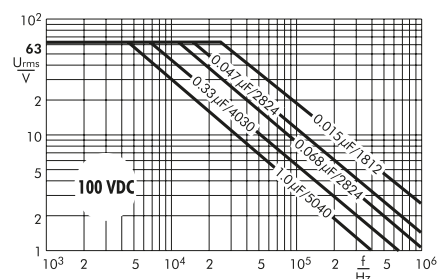
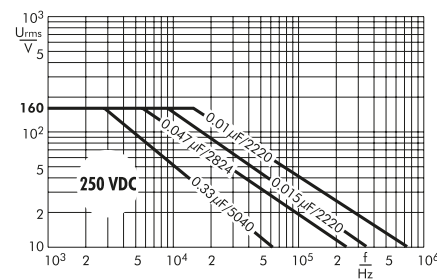
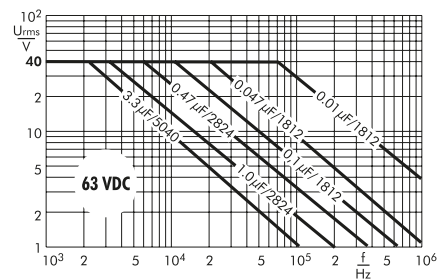

WIMA Miniature Capacitors in PCM 2.5 mm

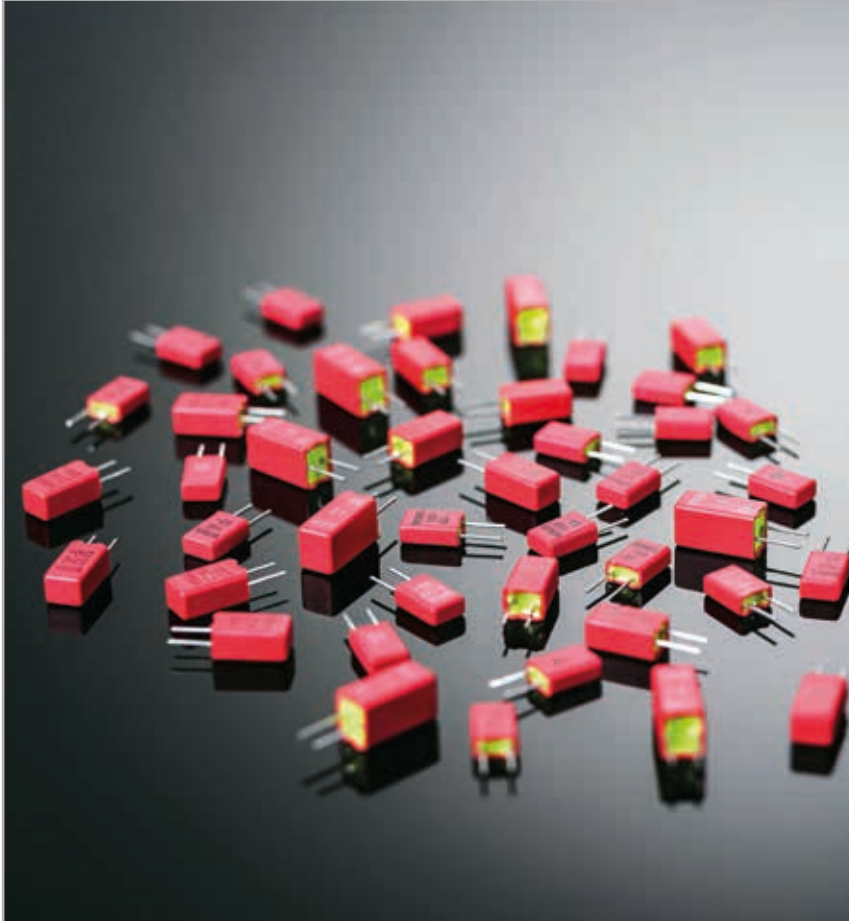

WIMA FKP 02

WIMA MKS 02

WIMA plastic film capacitors in PCM 2.5 mm are available in metallized, self-healing version WIMA MKS 02 or in pulse duty film and foil versions WIMA FKP 02. As a dielectric, Polyester or Polypropylene film is used. The capacitance range includes values of 100 pF through 1.0 μ F and voltage ratings of 50 VDC, 63 VDC, 100 VDC, 250 VDC and 400 VDC.

The realization of the smallest plastic film capacitors in the world has been made possible by the use of ultra-thin plastic film in thicknesses of 0.8 mm and below. The film processing with highly sensitive machines requires a high degree of experience and technical know-how.

The WIMA series with PCM 2.5 mm are contacted at the end surfaces and have very low self-inductance due to the small pin spacing of the capacitor and its fully contacted electrodes. Furthermore, the pulse and current loading capacities basically increase, the smaller the PCM can be designed, because – provided that the thickness of the film is the same – a longer band length is needed to achieve a particular capacitance value.

WIMA capacitors are produced with the proven box technology using solvent-resistant, flame-retardant plastic cases according to UL 94 V-0. They are environmentally compatible with the RoHS 2015/863/EU guidelines of the European Union.

WIMA subminiature capacitors in PCM 2.5 mm are outstandingly suitable as reservoir and decoupling capacitors for high-speed digital circuits and for HF decoupling in the field of high frequencies. Due to their excellent electrical properties they can replace ceramic capacitors in applications where quality and reliability are required. Due to their reduced dimensions they open up new possibilities for use in applications with limited space requirements and high package density.

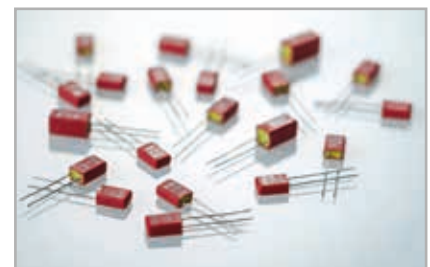

**Polypropylene (PP) Film/Foil Capacitors for Pulse Applications in PCM 2.5 mm.
Capacitances from 100 pF to 0.01 μ F. Rated Voltages from 63 VDC to 400 VDC.**

Special Features

- Pulse duty construction
- PCM 2.5 mm
- Close tolerances up to $\pm 2.5\%$
- Very low dissipation factor
- Negative capacitance change versus temperature
- Very low dielectric absorption
- According to RoHS 2015/863/EU

Typical Applications

For high frequency applications e.g.

- Sample and hold
- Timing
- LC-Filtering
- Oscillating circuits
- Audio equipment

Construction

Dielectric:

Polypropylene (PP) film

Capacitor electrodes:

Metal foil

Internal construction:

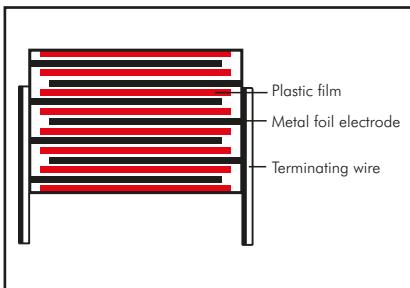

Encapsulation:

Solvent-resistant, flame-retardant plastic case with epoxy resin seal, UL 94 V-0

Terminations:

Tinned wire.

Marking:

Colour: Red. Marking: Black.

Electrical Data

Capacitance range:

100 pF to 0.01 μ F (E12-values on request)

Rated voltages:

63 VDC, 100 VDC, 250 VDC, 400 VDC

Capacitance tolerances:

$\pm 20\%$, $\pm 10\%$, $\pm 5\%$, $\pm 2.5\%$

Operating temperature range:

-55°C to $+100^\circ\text{C}$

Test specifications:

In accordance with IEC 60384-13

Climatic test category:

55/100/21 in accordance with IEC

Insulation resistance at $+20^\circ\text{C}$:

$\geq 3 \times 10^5\ \text{M}\Omega$

Measuring voltage:

$U_r = 63\ \text{V}$; $U_{\text{test}} = 50\ \text{V}/1\ \text{min.}$

$U_r \geq 100\ \text{V}$; $U_{\text{test}} = 100\ \text{V}/1\ \text{min.}$

Test voltage: $2 U_r$, 2 sec.

Maximum pulse rise time:

1000 V/ μ sec.

Dielectric absorption:

0.05%

Temperature coefficient:

$-200 \times 10^{-6}/+^\circ\text{C}$ (typical)

Dissipation factors at $+20^\circ\text{C}$: $\tan \delta$

at f	$C \leq 0.01\ \mu\text{F}$
1 kHz	$\leq 5 \times 10^{-4}$
10 kHz	$\leq 6 \times 10^{-4}$
100 kHz	$\leq 8 \times 10^{-4}$

Voltage derating:

A voltage derating factor of 1.35 % per K must be applied from $+85^\circ\text{C}$ for DC voltages and from $+75^\circ\text{C}$ for AC voltages.

Reliability:

Operational life $> 300\,000$ hours

Failure rate $< 5\ \text{fit}$ ($0.5 \times U_r$ and 40°C)

Mechanical Tests

Pull test on pins:

10 N in direction of pins according to IEC 60068-2-21

Vibration:

6 hours at 10...2000 Hz and 0.75 mm displacement amplitude or 10 g in accordance with IEC 60068-2-6

Low air density:

1 kPa = 10 mbar in accordance with IEC 60068-2-13

Bump test:

4000 bumps at $390\ \text{m}/\text{sec}^2$ in accordance with IEC 60068-2-29

Packing

Available taped and reeled.

Detailed taping information and graphs at the end of the catalogue.

For further details and graphs please refer to Technical Information.

Continuation

General Data

Capacitance	63 VDC/40 VAC*					100 VDC/63 VAC*				
	W	H	L	PCM**	Part number	W	H	L	PCM**	Part number
100 pF	2.5	7	4.6	2.5	FKP0C001000B00	2.5	7	4.6	2.5	FKP0D001000B00
150 "	2.5	7	4.6	2.5	FKP0C001500B00	2.5	7	4.6	2.5	FKP0D001500B00
220 "	2.5	7	4.6	2.5	FKP0C002200B00	2.5	7	4.6	2.5	FKP0D002200B00
330 "	2.5	7	4.6	2.5	FKP0C003300B00	2.5	7	4.6	2.5	FKP0D003300B00
470 "	2.5	7	4.6	2.5	FKP0C004700B00	2.5	7	4.6	2.5	FKP0D004700B00
680 "	2.5	7	4.6	2.5	FKP0C006800B00	2.5	7	4.6	2.5	FKP0D006800B00
1000 pF	2.5	7	4.6	2.5	FKP0C011000B00	2.5	7	4.6	2.5	FKP0D011000B00
1500 "	2.5	7	4.6	2.5	FKP0C011500B00	2.5	7	4.6	2.5	FKP0D011500B00
2200 "	3	7.5	4.6	2.5	FKP0C012200C00	3	7.5	4.6	2.5	FKP0D012200C00
3300 "	3.8	8.5	4.6	2.5	FKP0C013300D00	3.8	8.5	4.6	2.5	FKP0D013300D00
4700 "	4.6	9	4.6	2.5	FKP0C014700E00	4.6	9	4.6	2.5	FKP0D014700E00
6800 "	4.6	9	4.6	2.5	FKP0C016800E00	4.6	9	4.6	2.5	FKP0D016800E00
0.01 µF	5.5	10	4.6	2.5	FKP0C021000F00	5.5	10	4.6	2.5	FKP0D021000F00

Capacitance	250 VDC/160 VAC*					400 VDC/200 VAC*				
	W	H	L	PCM**	Part number	W	H	L	PCM**	Part number
100 pF	2.5	7	4.6	2.5	FKP0F001000B00	2.5	7	4.6	2.5	FKP0G001000B00
150 "	2.5	7	4.6	2.5	FKP0F001500B00	2.5	7	4.6	2.5	FKP0G001500B00
220 "	2.5	7	4.6	2.5	FKP0F002200B00	2.5	7	4.6	2.5	FKP0G002200B00
330 "	2.5	7	4.6	2.5	FKP0F003300B00	2.5	7	4.6	2.5	FKP0G003300B00
470 "	2.5	7	4.6	2.5	FKP0F004700B00	2.5	7	4.6	2.5	FKP0G004700B00
680 "	2.5	7	4.6	2.5	FKP0F006800B00	3	7.5	4.6	2.5	FKP0G006800C00
1000 pF	2.5	7	4.6	2.5	FKP0F011000B00	3.8	8.5	4.6	2.5	FKP0G011000D00
1500 "	3	7.5	4.6	2.5	FKP0F011500C00	4.6	9	4.6	2.5	FKP0G011500E00
2200 "	3.8	8.5	4.6	2.5	FKP0F012200D00	4.6	9	4.6	2.5	FKP0G012200E00
3300 "	4.6	9	4.6	2.5	FKP0F013300E00	5.5	10	4.6	2.5	FKP0G013300F00
4700 "	5.5	10	4.6	2.5	FKP0F014700F00					

* AC voltage: $f \leq 400 \text{ Hz}$; $1.4 \times U_{\text{rms}} + U_{\text{DC}} \leq U_r$

** PCM = Printed circuit module = pin spacing

Dims. in mm.

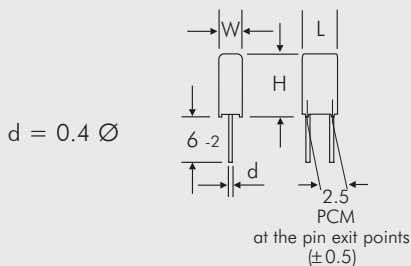

Part number completion:

- Tolerance: 20 % = M
- 10 % = K
- 5 % = J
- 2.5 % = H
- Packing: bulk = S
- Pin length: 6-2 = SD

Taped version see page 157.

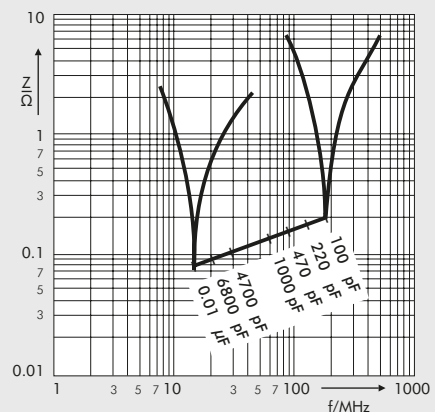

Impedance change with frequency (general guide).

Rights reserved to amend design data without prior notification.

Metallized Polyester (PET) Capacitors in PCM 2.5 mm. Capacitances from 3300 pF to 1.0 μF. Rated Voltages from 63 VDC to 400 VDC.

Special Features

- High volume/capacitance ratio and reduced base
- PCM 2.5 mm
- Self-healing
- According to RoHS 2015/863/EU

Typical Applications

For general DC-applications e.g.

- By-pass
- Blocking
- Coupling and decoupling
- Timing

Construction

Dielectric:

Polyethylene-terephthalate (PET) film

Capacitor electrodes:

Vacuum-deposited

Internal construction:

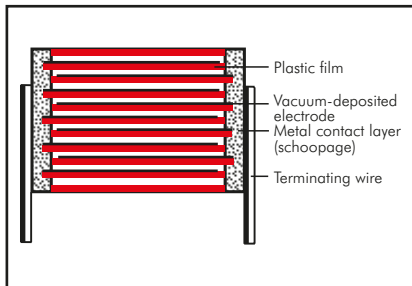

Encapsulation:

Solvent-resistant, flame-retardant plastic case with epoxy resin seal, UL 94 V-0

Terminations:

Tinned wire.

Marking:

Colour: Red. Marking: Black.

Electrical Data

Capacitance range:

3300 pF to 1.0 μF (E12-values on request)

Rated voltages:

63 VDC, 100 VDC, 250 VDC, 400 VDC

Capacitance tolerances:

±20%, ±10% (±5% available subject to special enquiry)

Operating temperature range:

-55° C to +105° C

Test specifications:

In accordance with IEC 60384-2

Climatic test category:

55/100/21 in accordance with IEC

Insulation resistance at +20° C:0

U_r	U_{test}	$C \leq 0.33 \mu F$	$0.33 \mu F < C \leq 1.0 \mu F$
63 VDC	50 V	$\geq 3.75 \times 10^3 M\Omega$	$\geq 1250 \text{ sec} (M\Omega \times \mu F)$
$\geq 100 \text{ VDC}$	100 V	$\geq 1 \times 10^4 M\Omega$	-

Measuring time: 1 min.

Test voltage: $1.6 U_r$, 2 sec.

Maximum pulse rise time:

Capacitance pF/μF	max. pulse rise time V/μsec
3300 ... 6800	100
0.01 ... 0.022	50
0.033 ... 0.068	30
0.1 ... 0.33	20
0.47 ... 1.0	15

Dissipation factors at +20° C: tan δ

at f	$C \leq 0.1 \mu F$	$0.1 \mu F < C \leq 1.0 \mu F$
1 kHz	$\leq 8 \times 10^{-3}$	$\leq 8 \times 10^{-3}$
10 kHz	$\leq 15 \times 10^{-3}$	$\leq 15 \times 10^{-3}$
100 kHz	$\leq 30 \times 10^{-3}$	-

Voltage derating:

A voltage derating factor of 1.25 % per K must be applied from +85° C for DC voltages and from +75° C for AC voltages.

Reliability:

Operational life > 300000 hours

Failure rate < 2 fit ($0.5 \times U_r$ and 40° C)

Mechanical Tests

Pull test on pins:

10 N in direction of pins according to IEC 60068-2-21

Vibration:

6 hours at 10...2000 Hz and 0.75 mm displacement amplitude or 10 g in accordance with IEC 60068-2-6

Low air density:

1kPa = 10 mbar in accordance with IEC 60068-2-13

Bump test:

4000 bumps at 390 m/sec² in accordance with IEC 60068-2-29

Packing

Available taped and reeled.

Detailed taping information and graphs at the end of the catalogue.

For further details and graphs please refer to Technical Information.

Continuation

General Data

Capacitance	63 VDC/40 VAC*					100 VDC/63 VAC*				
	W	H	L	PCM**	Part number	W	H	L	PCM**	Part number
0.01 μ F	2.5	7	4.6	2.5	MKS0C021000B00	2.5	7	4.6	2.5	MKS0D021000B00
0.015 "	2.5	7	4.6	2.5	MKS0C021500B00	2.5	7	4.6	2.5	MKS0D021500B00
0.022 "	2.5	7	4.6	2.5	MKS0C022200B00	2.5	7	4.6	2.5	MKS0D022200B00
0.033 "	2.5	7	4.6	2.5	MKS0C023300B00	2.5	7	4.6	2.5	MKS0D023300B00
0.047 "	2.5	7	4.6	2.5	MKS0C024700B00	2.5	7	4.6	2.5	MKS0D024700B00
0.068 "	2.5	7	4.6	2.5	MKS0C026800B00	2.5	7	4.6	2.5	MKS0D026800B00
0.1 μ F	3	7.5	4.6	2.5	MKS0C031000C00	3	7.5	4.6	2.5	MKS0D031000C00
0.15 "	3	7.5	4.6	2.5	MKS0C031500C00	3.8	8.5	4.6	2.5	MKS0D031500D00
0.22 "	3	7.5	4.6	2.5	MKS0C032200C00	4.6	9	4.6	2.5	MKS0D032200E00
0.33 "	3.8	8.5	4.6	2.5	MKS0C033300D00	5.5	10	4.6	2.5	MKS0D033300F00
0.47 "	4.6	9	4.6	2.5	MKS0C034700E00					
0.68 "	5.5	10	4.6	2.5	MKS0C036800F00					
1.0 μ F	5.5	10	4.6	2.5	MKS0C041000F00					

Capacitance	250 VDC/160 VAC*					400 VDC/200 VAC*				
	W	H	L	PCM**	Part number	W	H	L	PCM**	Part number
3300 pF	2.5	7	4.6	2.5	MKS0F013300B00	2.5	7	4.6	2.5	MKS0G013300B00
4700 "	2.5	7	4.6	2.5	MKS0F014700B00	2.5	7	4.6	2.5	MKS0G014700B00
6800 "	2.5	7	4.6	2.5	MKS0F016800B00	2.5	7	4.6	2.5	MKS0G016800B00
0.01 μ F	2.5	7	4.6	2.5	MKS0F021000B00	3	7.5	4.6	2.5	MKS0G021000C00
0.015 "	2.5	7	4.6	2.5	MKS0F021500B00	3.8	8.5	4.6	2.5	MKS0G021500D00
0.022 "	2.5	7	4.6	2.5	MKS0F022200B00	4.6	9	4.6	2.5	MKS0G022200E00
0.033 "	3	7.5	4.6	2.5	MKS0F023300C00	5.5	10	4.6	2.5	MKS0G023300F00
0.047 "	3.8	8.5	4.6	2.5	MKS0F024700D00	5.5	10	4.6	2.5	MKS0G024700F00
0.068 "	4.6	9	4.6	2.5	MKS0F026800E00					
0.1 μ F	5.5	10	4.6	2.5	MKS0F031000F00					

* AC voltage: $f = 50 \text{ Hz}$; $1.4 \times U_{\text{rms}} + \text{UDC} \leq U_r$

** PCM = Printed circuit module = pin spacing

Dims. in mm.

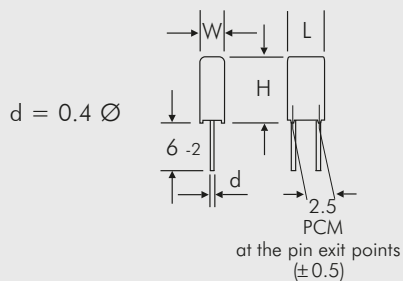

Part number completion:

Tolerance: 20 % = M
 10 % = K
 5 % = J
 Packing: bulk = S
 Pin length: 6-2 = SD
 Taped version see page 157.

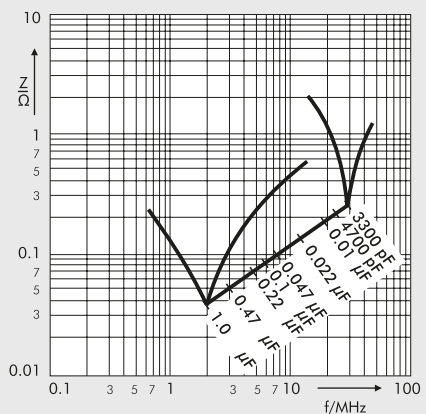

Impedance change with frequency (general guide).

Rights reserved to amend design data without prior notification.



WIMA Capacitors in PCM 5 - 15 mm with Pulse Duty Film/Foil Construction



are determined from the specific break-down strength of the material.

WIMA film/foil capacitors in PCM 5 mm, 7.5 mm, 10 mm and 15 mm are available in two dielectric versions.

Capacitors with a Polyester dielectric (PET) are suitable for general applications such as coupling, decoupling and by-passing.

Polypropylene capacitors (PP) are used in the high frequency field. This includes resonant circuits, power supplies, deflection circuits, oscillator circuits and audio equipment.

WIMA capacitors are produced with the proven box technology using solvent-resistant, flame-retardant plastic cases according to UL 94 V-0. They are environmentally compatible with the RoHS 2015/863/EU regulations of the European Union.

WIMA FKS 2

WIMA FKP 2

WIMA FKS 3

WIMA FKP 3

In the case of film and foil types, the electrode is not applied as for the metalized capacitors, but is wound with the dielectric as a metal foil. Due to their lower series resistance, the components produced this way have excellent pulse and current carrying capability, as well as a very high insulation resistance.

The film/foil construction is mainly used for capacitors with smaller capacitance value. The advantage of this construction principle is the easy contactability of the metal foil electrodes and the good pulse strength. To avoid breakdowns caused by weak spots in the dielectric, the insulating film chosen is always thicker than theoretically required by the values which



**Polyester (PET) Film/Foil Capacitors for Pulse Applications in PCM 5 mm.
Capacitances from 1000 pF to 0.047 µF. Rated Voltages from 63 VDC to 630 VDC.**

Special Features

- Pulse duty construction
- According to RoHS 2015/863/EU

Typical Applications

For general DC-applications e.g.

- Coupling
- Decoupling

Construction

Dielectric:

Polyethylene-terephthalate (PET) film

Capacitor electrodes:

Metal foil

Internal construction:

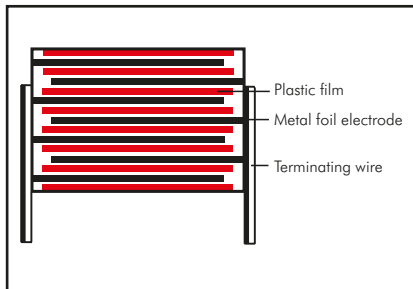

Encapsulation:

Solvent-resistant, flame-retardant plastic case with epoxy resin seal, UL 94 V-0

Terminations:

Tinned wire.

Marking:

Colour: Red. Marking: Black.

Electrical Data

Capacitance range:

1000 pF to 0.047 µF
(E12-values on request)

Rated voltages:

63 VDC, 100 VDC, 250 VDC, 400 VDC, 630 VDC

Capacitance tolerances:

± 20%, ±10%, ±5%

Operating temperature range:

-55° C to +105° C

Test specifications:

In accordance with IEC 60384-11

Climatic test category:

55/100/56 in accordance with IEC

Insulation resistance at +20° C:

≥ 1 x 10⁵ MΩ

Measuring voltage: 100 V/1 min.

Test voltage: 2 U_r, 2 sec.

Maximum pulse rise time:

1000 V/µsec

Dissipation factors at +20° C: tan δ

at f	C ≤ 0.047 µF
1 kHz	≤ 7 x 10 ⁻³
10 kHz	≤ 15 x 10 ⁻³
100 kHz	≤ 20 x 10 ⁻³

Voltage derating:

A voltage derating factor of 1.25 % per K must be applied from +85° C for DC voltages and from +75° C for AC voltages.

Reliability:

Operational life > 300 000 hours

Failure rate < 5 fit (0.5 x U_r and 40° C)

Mechanical Tests

Pull test on pins:

10 N in direction of pins according to IEC 60068-2-21

Vibration:

6 hours at 10...2000 Hz and 0.75 mm displacement amplitude or 10 g in accordance with IEC 60068-2-6

Low air density:

1kPa = 10 mbar in accordance with IEC 60068-2-13

Bump test:

4000 bumps at 390 m/sec² in accordance with IEC 60068-2-29

Packing

Available taped and reeled.

Detailed taping information and graphs at the end of the catalogue.

For further details and graphs please refer to Technical Information.

Continuation

General Data

Capacitance	63 VDC/40 VAC*					100 VDC/63 VAC*				
	W	H	L	PCM**	Part number	W	H	L	PCM**	Part number
1000 pF	2.5	6.5	7.2	5	FKS2C011001A00	2.5	6.5	7.2	5	FKS2D011001A00
1500 "	2.5	6.5	7.2	5	FKS2C011501A00	2.5	6.5	7.2	5	FKS2D011501A00
2200 "	2.5	6.5	7.2	5	FKS2C012201A00	2.5	6.5	7.2	5	FKS2D012201A00
3300 "	2.5	6.5	7.2	5	FKS2C013301A00	2.5	6.5	7.2	5	FKS2D013301A00
4700 "	2.5	6.5	7.2	5	FKS2C014701A00	2.5	6.5	7.2	5	FKS2D014701A00
6800 "	2.5	6.5	7.2	5	FKS2C016801A00	2.5	6.5	7.2	5	FKS2D016801A00
0.01 µF	3	7.5	7.2	5	FKS2C021001B00	3	7.5	7.2	5	FKS2D021001B00
0.015 "	3.5	8.5	7.2	5	FKS2C021501C00	3.5	8.5	7.2	5	FKS2D021501C00
0.022 "	4.5	9.5	7.2	5	FKS2C022201E00	4.5	9.5	7.2	5	FKS2D022201E00
0.033 "	5.5	11.5	7.2	5	FKS2C023301H00	5.5	11.5	7.2	5	FKS2D023301H00
0.047 "	7.2	13	7.2	5	FKS2C024701K00	7.2	13	7.2	5	FKS2D024701K00

Capacitance	250 VDC/160 VAC*					400 VDC/200 VAC*				
	W	H	L	PCM**	Part number	W	H	L	PCM**	Part number
1000 pF	2.5	6.5	7.2	5	FKS2F011001A00	2.5	6.5	7.2	5	FKS2G011001A00
1500 "	2.5	6.5	7.2	5	FKS2F011501A00	2.5	6.5	7.2	5	FKS2G011501A00
2200 "	2.5	6.5	7.2	5	FKS2F012201A00	2.5	6.5	7.2	5	FKS2G012201A00
3300 "	2.5	6.5	7.2	5	FKS2F013301A00	2.5	6.5	7.2	5	FKS2G013301A00
4700 "	2.5	6.5	7.2	5	FKS2F014701A00	2.5	6.5	7.2	5	FKS2G014701A00
6800 "	2.5	6.5	7.2	5	FKS2F016801A00	3	7.5	7.2	5	FKS2G016801B00
0.01 µF	3	7.5	7.2	5	FKS2F021001B00	3.5	8.5	7.2	5	FKS2G021001C00
0.015 "	3.5	8.5	7.2	5	FKS2F021501C00	4.5	9.5	7.2	5	FKS2G021501E00
0.022 "	4.5	9.5	7.2	5	FKS2F022201E00	5.5	11.5	7.2	5	FKS2G022201H00
0.033 "	5.5	11.5	7.2	5	FKS2F023301H00	7.2	13	7.2	5	FKS2G023301K00
0.047 "	7.2	13	7.2	5	FKS2F024701K00					

Capacitance	630 VDC/250 VAC*				
	W	H	L	PCM**	Part number
1000 pF	3	7.5	7.2	5	FKS2J011001B00
1500 "	3	7.5	7.2	5	FKS2J011501B00
2200 "	3	7.5	7.2	5	FKS2J012201B00
3300 "	3	7.5	7.2	5	FKS2J013301B00
4700 "	3.5	8.5	7.2	5	FKS2J014701C00
6800 "	4.5	9.5	7.2	5	FKS2J016801E00
0.01 µF	4.5	9.5	7.2	5	FKS2J021001E00
0.015 "	5.5	11.5	7.2	5	FKS2J021501H00
0.022 "	7.2	13	7.2	5	FKS2J022201K00

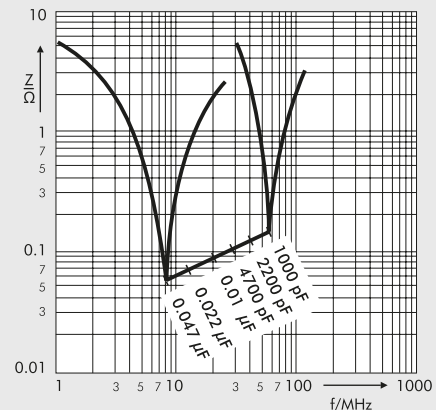

Impedance change with frequency (general guide).

Part number completion:

Tolerance: 20 % = M

10 % = K

5 % = J

Packing: bulk = S

Pin length: 6-2 = SD

Taped version see page 157.

Dims. in mm.

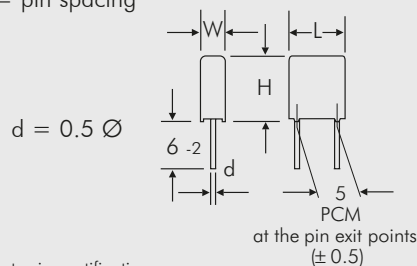

Rights reserved to amend design data without prior notification.

**Polypropylene (PP) Film/Foil Capacitors for Pulse Applications in PCM 5 mm.
Capacitances from 33 pF to 0.033 µF. Rated Voltages from 63 VDC to 1000 VDC.**

Special Features

- Pulse duty construction
- Close tolerances up to $\pm 2.5\%$ ($\pm 1\%$ on request)
- Very low dissipation factor
- Negative capacitance change versus temperature
- Very low dielectric absorption
- According to RoHS 2015/863/EU

Typical Applications

For high frequency applications e.g.

- Sample and hold
- Timing
- LC-Filtering
- Oscillating circuits
- Audio equipment

Construction

Dielectric:

Polypropylene (PP) film

Capacitor electrodes:

Metal foil

Internal construction:

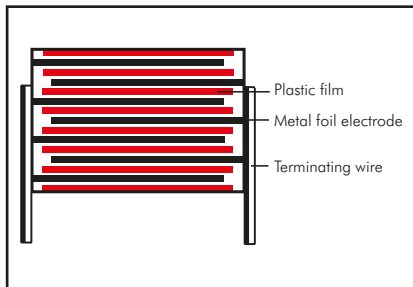

Encapsulation:

Solvent-resistant, flame-retardant plastic case with epoxy resin seal, UL 94 V-0

Terminations:

Tinned wire.

Marking:

Colour: Red. Marking: Black.

Electrical Data

Capacitance range:

33 pF to 0.033 µF (E12-values on request)

Rated voltages:

63 VDC, 100 VDC, 250 VDC, 400 VDC, 630 VDC, 800 VDC, 1000 VDC

Capacitance tolerances:

$\pm 20\%$, $\pm 10\%$, $\pm 5\%$, $\pm 2.5\%$ ($\pm 2\%$, $\pm 1.5\%$ or $\pm 1\%$ available as precision capacitors subject to special enquiry)

Operating temperature range:

-55°C to $+100^\circ\text{C}$

Test specifications:

In accordance with IEC 60384-13

Climatic test category:

55/100/56 in accordance with IEC

Insulation resistance at $+20^\circ\text{C}$:

$\geq 3 \times 10^5 \text{ M}\Omega$

Measuring voltage:

$U_r = 63 \text{ V}$: $U_{\text{test}} = 50 \text{ V/1 min.}$

$U_r \geq 100 \text{ V}$: $U_{\text{test}} = 100 \text{ V/1 min.}$

Dissipation factors at $+20^\circ\text{C}$: $\tan \delta$

at f	$C \leq 1000 \text{ pF}$	$1000 \text{ pF} < C \leq 4700 \text{ pF}$	$C > 4700 \text{ pF}$
1 kHz	$\leq 5 \times 10^{-4}$	$\leq 5 \times 10^{-4}$	$\leq 5 \times 10^{-4}$
10 kHz	$\leq 6 \times 10^{-4}$	$\leq 6 \times 10^{-4}$	$\leq 6 \times 10^{-4}$
100 kHz	$\leq 8 \times 10^{-4}$	$\leq 8 \times 10^{-4}$	–
1 MHz	$\leq 10 \times 10^{-4}$	–	–

Test voltage: $2 U_r$, 2 sec.

Maximum pulse rise time:

1000 V/ μsec

Dielectric absorption:

0.05%

Temperature coefficient:

$-200 \times 10^{-6}/^\circ\text{C}$ (typical)

Voltage derating:

A voltage derating factor of 1.35 % per K must be applied from $+85^\circ\text{C}$ for DC voltages and from $+75^\circ\text{C}$ for AC voltages

Reliability:

Operational life $> 300\,000$ hours

Failure rate $< 5 \text{ fit}$ ($0.5 \times U_r$ and 40°C)

Mechanical Tests

Pull test on pins:

10 N in direction of pins according to IEC 60068-2-21

Vibration:

6 hours at 10...2000 Hz and 0.75 mm displacement amplitude or 10 g in accordance with IEC 60068-2-6

Low air density:

1 kPa = 10 mbar in accordance with IEC 60068-2-13

Bump test:

4000 bumps at 390 m/sec^2 in accordance with IEC 60068-2-29

Packing

Available taped and reeled.

Detailed taping information and graphs at the end of the catalogue.

For further details and graphs please refer to Technical Information.

Continuation

General Data

Capacitance	63 VDC/40 VAC*					100 VDC/63 VAC*				
	W	H	L	PCM**	Part number	W	H	L	PCM**	Part number
100 pF	4.5	6	7.2	5	FKP2C001001D00	4.5	6	7.2	5	FKP2D001001D00
150 "	4.5	6	7.2	5	FKP2C001501D00	4.5	6	7.2	5	FKP2D001501D00
220 "	4.5	6	7.2	5	FKP2C002201D00	4.5	6	7.2	5	FKP2D002201D00
330 "	4.5	6	7.2	5	FKP2C003301D00	4.5	6	7.2	5	FKP2D003301D00
470 "	4.5	6	7.2	5	FKP2C004701D00	4.5	6	7.2	5	FKP2D004701D00
680 "	4.5	6	7.2	5	FKP2C006801D00	4.5	6	7.2	5	FKP2D006801D00
1000 pF	4.5	6	7.2	5	FKP2C011001D00	4.5	6	7.2	5	FKP2D011001D00
1500 "	4.5	6	7.2	5	FKP2C011501D00	4.5	6	7.2	5	FKP2D011501D00
2200 "	4.5	6	7.2	5	FKP2C012201D00	4.5	6	7.2	5	FKP2D012201D00
3300 "	4.5	6	7.2	5	FKP2C013301D00	5.5	7	7.2	5	FKP2D013301G00
4700 "	4.5	6	7.2	5	FKP2C014701D00	5.5	7	7.2	5	FKP2D014701G00
6800 "	4.5	6	7.2	5	FKP2C016801D00	5.5	7	7.2	5	FKP2D016801G00
0.01 µF	5.5	7	7.2	5	FKP2C021001G00	6.5	8	7.2	5	FKP2D021001I00
0.015 "	6.5	8	7.2	5	FKP2C021501I00	7.2	8.5	7.2	5	FKP2D021501J00
0.022 "	7.2	8.5	7.2	5	FKP2C022201J00	8.5	10	7.2	5	FKP2D022201L00
0.033 "	8.5	10	7.2	5	FKP2C023301L00					

Capacitance	250 VDC/160 VAC*					400 VDC/220 VAC*				
	W	H	L	PCM**	Part number	W	H	L	PCM**	Part number
100 pF	4.5	6	7.2	5	FKP2F001001D00	4.5	6	7.2	5	FKP2G001001D00
150 "	4.5	6	7.2	5	FKP2F001501D00	4.5	6	7.2	5	FKP2G001501D00
220 "	4.5	6	7.2	5	FKP2F002201D00	4.5	6	7.2	5	FKP2G002201D00
330 "	4.5	6	7.2	5	FKP2F003301D00	4.5	6	7.2	5	FKP2G003301D00
470 "	4.5	6	7.2	5	FKP2F004701D00	4.5	6	7.2	5	FKP2G004701D00
680 "	4.5	6	7.2	5	FKP2F006801D00	4.5	6	7.2	5	FKP2G006801D00
1000 pF	4.5	6	7.2	5	FKP2F011001D00	4.5	6	7.2	5	FKP2G011001D00
1500 "	4.5	6	7.2	5	FKP2F011501D00	4.5	6	7.2	5	FKP2G011501D00
2200 "	4.5	6	7.2	5	FKP2F012201D00	4.5	6	7.2	5	FKP2G012201D00
3300 "	5.5	7	7.2	5	FKP2F013301G00	5.5	7	7.2	5	FKP2G013301G00
4700 "	6.5	8	7.2	5	FKP2F014701I00	6.5	8	7.2	5	FKP2G014701I00
6800 "	6.5	8	7.2	5	FKP2F016801I00	7.2	8.5	7.2	5	FKP2G016801J00
0.01 µF	7.2	8.5	7.2	5	FKP2F021001J00	8.5	10	7.2	5	FKP2G021001L00
0.015 "	8.5	10	7.2	5	FKP2F021501L00					

* AC voltage: $f \leq 1000 \text{ Hz}$; $1.4 \times U_{\text{rms}} + U_{\text{DC}} \leq U_r$

** PCM = Printed circuit module = pin spacing.

E12 values and individual values available from 27 pF up on request.

Dims. in mm.

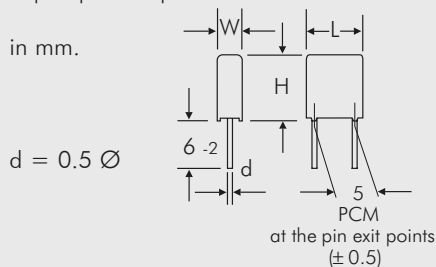

Rights reserved to amend design data without prior notification.

Part number completion:

- Tolerance: 20 % = M
- 10 % = K
- 5 % = J
- 2.5 % = H
- 2 % = G
- 1.5 % = F
- 1 % = E

Packing: bulk = S

Pin length: 6-2 = SD

Taped version see page 157.

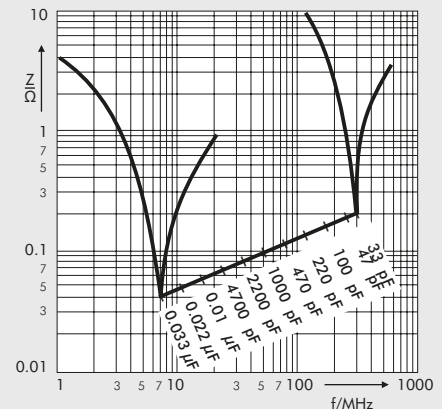

Impedance change with frequency (general guide).

Continuation page 39

Continuation

General Data

Capacitance	630 VDC/250 VAC*					800 VDC/250 VAC*				
	W	H	L	PCM**	Part number	W	H	L	PCM**	Part number
100 pF	4.5	6	7.2	5	FKP2J001001D00	4.5	6	7.2	5	FKP2L001001D00
150 "	4.5	6	7.2	5	FKP2J001501D00	4.5	6	7.2	5	FKP2L001501D00
220 "	4.5	6	7.2	5	FKP2J002201D00	4.5	6	7.2	5	FKP2L002201D00
330 "	4.5	6	7.2	5	FKP2J003301D00	4.5	6	7.2	5	FKP2L003301D00
470 "	4.5	6	7.2	5	FKP2J004701D00	5.5	7	7.2	5	FKP2L004701G00
680 "	4.5	6	7.2	5	FKP2J006801D00	5.5	7	7.2	5	FKP2L006801G00
1000 pF	4.5	6	7.2	5	FKP2J011001D00	5.5	7	7.2	5	FKP2L011001G00
1500 "	4.5	6	7.2	5	FKP2J011501D00	5.5	7	7.2	5	FKP2L011501G00
2200 "	5.5	7	7.2	5	FKP2J012201G00	6.5	8	7.2	5	FKP2L012201I00
3300 "	6.5	8	7.2	5	FKP2J013301I00	7.2	8.5	7.2	5	FKP2L013301J00
4700 "	6.5	8	7.2	5	FKP2J014701I00	8.5	10	7.2	5	FKP2L014701L00
6800 "	7.2	8.5	7.2	5	FKP2J016801J00					
0.01 µF	8.5	10	7.2	5	FKP2J021001L00					

Capacitance	1000 VDC/250 VAC*				
	W	H	L	PCM**	Part number
33 pF	4.5	6	7.2	5	FKP2O100331D00
47 "	4.5	6	7.2	5	FKP2O100471D00
68 "	4.5	6	7.2	5	FKP2O100681D00
100 pF	4.5	6	7.2	5	FKP2O101001D00
150 "	4.5	6	7.2	5	FKP2O101501D00
220 "	4.5	6	7.2	5	FKP2O102201D00
330 "	4.5	6	7.2	5	FKP2O103301D00
470 "	5.5	7	7.2	5	FKP2O104701G00
680 "	5.5	7	7.2	5	FKP2O106801G00
1000 pF	6.5	8	7.2	5	FKP2O111001I00
1500 "	7.2	8.5	7.2	5	FKP2O111501J00
2200 "	8.5	10	7.2	5	FKP2O112201L00

E12 values and individual values available from 27 pF up on request.

Dims. in mm.

Part number completion:

Tolerance: 20 % = M
 10 % = K
 5 % = J
 2.5 % = H
 2 % = G
 1.5 % = F
 1 % = E

Packing: bulk = S
 Pin length: 6-2 = SD

Taped version see page 157.

* AC voltage: $f \leq 1000 \text{ Hz}$; $1.4 \times U_{\text{rms}} + \text{UDC} \leq U_r$

** PCM = Printed circuit module = pin spacing.

Rights reserved to amend design data without prior notification.

Permissible AC voltage in relation to frequency at 10° C internal temperature rise (general guide).

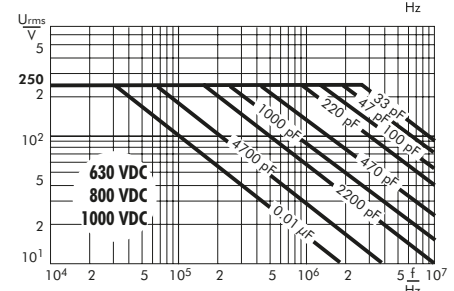
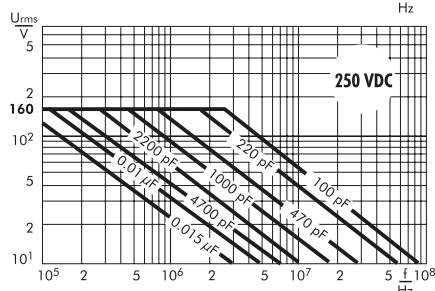
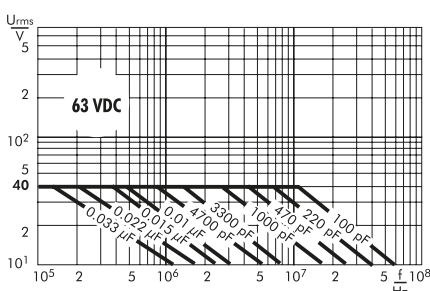
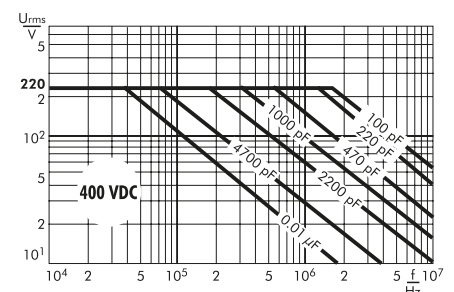
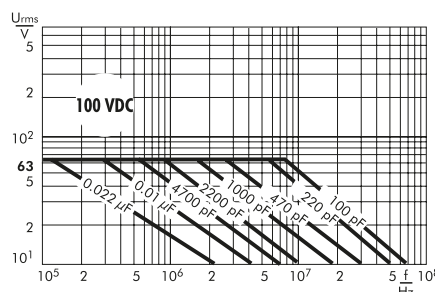

**Polyester (PET) Film/Foil Capacitors for Pulse Applications
in PCM 7.5 mm to 15 mm. Capacitances from 1000 pF to 0.22 μ F.
Rated Voltages from 100 VDC to 630 VDC.**

Special Features

- Pulse duty construction
- According to RoHS 2015/863/EU

Typical Applications

For general DC-applications e.g.

- Coupling
- Decoupling

Construction

Dielectric:

Polyethylene-terephthalate (PET) film

Capacitor electrodes:

Metal foil

Internal construction:

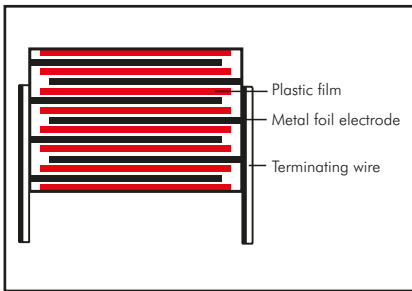

Encapsulation:

Solvent-resistant, flame-retardant plastic case with epoxy resin seal, UL 94 V-0

Terminations:

Tinned wire.

Marking:

Colour: Red. Marking: Black.

Electrical Data

Capacitance range:

1000 pF to 0.22 μ F (E12-values on request)

Rated voltages:

100 VDC, 250 VDC, 400 VDC, 630 VDC

Capacitance tolerances:

$\pm 20\%$, $\pm 10\%$, $\pm 5\%$,

Operating temperature range:

-55°C to $+105^\circ\text{C}$

Test specifications:

In accordance with IEC 60384-11

Climatic test category:

55/100/56 in accordance with IEC

Insulation resistance at $+20^\circ\text{C}$:

$\geq 1 \times 10^5\ \text{M}\Omega$

Measuring voltage: 100 V/1 min.

Test voltage: $2 U_r$, 2 sec.

Maximum pulse rise time:

1000 V/ μ sec.

Dissipation factors at $+20^\circ\text{C}$: $\tan \delta$

at f	$C \leq 0.22\ \mu\text{F}$
1 kHz	$\leq 7 \times 10^{-3}$
10 kHz	$\leq 15 \times 10^{-3}$
100 kHz	$\leq 20 \times 10^{-3}$

Voltage derating:

A voltage derating factor of 1.25 % per K must be applied from $+85^\circ\text{C}$ for DC voltages and from $+75^\circ\text{C}$ for AC voltages.

Reliability:

Operational life > 300000 hours

Failure rate < 5 fit ($0.5 \times U_r$ and 40°C)

Mechanical Tests

Pull test on pins:

10 N in direction of pins according to IEC 60068-2-21

Vibration:

6 hours at 10...2000 Hz and 0.75 mm displacement amplitude or 10 g in accordance with IEC 60068-2-6

Low air density:

1 kPa = 10 mbar in accordance with IEC 60068-2-13

Bump test:

4000 bumps at $390\ \text{m}/\text{sec}^2$ in accordance with IEC 60068-2-29

Packing

Available taped and reeled.

Detailed taping information and graphs at the end of the catalogue.

For further details and graphs please refer to Technical Information.

Continuation

General Data

Capacitance	100 VDC/63 VAC*					250 VDC/160 VAC*				
	W	H	L	PCM**	Part number	W	H	L	PCM**	Part number
1000 pF	3	8.5	10	7.5	FKS3D011002B00	3	8.5	10	7.5	FKS3F011002B00
1500 "	3	8.5	10	7.5	FKS3D011502B00	3	8.5	10	7.5	FKS3F011502B00
2200 "	3	8.5	10	7.5	FKS3D012202B00	3	8.5	10	7.5	FKS3F012202B00
3300 "	3	8.5	10	7.5	FKS3D013302B00	3	8.5	10	7.5	FKS3F013302B00
4700 "	3	8.5	10	7.5	FKS3D014702B00	3	8.5	10	7.5	FKS3F014702B00
6800 "	3	8.5	10	7.5	FKS3D016802B00	3	9	13	10	FKS3F014703A00
						3	8.5	10	7.5	FKS3F016802B00
						3	9	13	10	FKS3F016803A00
0.01 µF	3	8.5	10	7.5	FKS3D021002B00	3	9	13	10	FKS3F021003A00
0.015 "	3	9	13	10	FKS3D021003A00	4	9.5	13	10	FKS3F021503D00
	3	8.5	10	7.5	FKS3D021502B00					
0.022 "	3	9	13	10	FKS3D021503A00	5	11	13	10	FKS3F022203F00
	3	8.5	10	7.5	FKS3D022202B00					
0.033 "	3	9	13	10	FKS3D022203A00	6	12	13	10	FKS3F023303G00
	4	9.5	13	10	FKS3D023303D00					
0.047 "	4	9.5	13	10	FKS3D024703D00	6	12.5	18	15	FKS3F024704C00
0.068 "	5	11	13	10	FKS3D026803F00	7	14	18	15	FKS3F026804D00
0.1 µF	6	12	13	10	FKS3D031003G00	8	15	18	15	FKS3F031004F00
0.15 "	7	14	18	15	FKS3D031504D00	9	16	18	15	FKS3F031504J00
0.22 "	8	15	18	15	FKS3D032204F00					

Capacitance	400 VDC/250 VAC*					630 VDC/300 VAC*				
	W	H	L	PCM**	Part number	W	H	L	PCM**	Part number
1000 pF	3	9	13	10	FKS3G011003A00	3	9	13	10	FKS3J011003A00
1500 "	3	9	13	10	FKS3G011503A00	3	9	13	10	FKS3J011503A00
2200 "	3	9	13	10	FKS3G012203A00	3	9	13	10	FKS3J012203A00
3300 "	3	9	13	10	FKS3G013303A00	4	9.5	13	10	FKS3J013303D00
4700 "	3	9	13	10	FKS3G014703A00	4	9.5	13	10	FKS3J014703D00
6800 "	3	9	13	10	FKS3G016803A00	5	11	13	10	FKS3J016803F00
0.01 µF	4	9.5	13	10	FKS3G021003D00	6	12	13	10	FKS3J021003G00
0.015 "	5	11	13	10	FKS3G021503F00	6	12.5	18	15	FKS3J021504C00
0.022 "	6	12	13	10	FKS3G022203G00	7	14	18	15	FKS3J022204D00
0.033 "	6	12.5	18	15	FKS3G023304C00	8	15	18	15	FKS3J023304F00
0.047 "	7	14	18	15	FKS3G024704D00					
0.068 "	8	15	18	15	FKS3G026804F00					
0.1 µF	9	16	18	15	FKS3G031004J00					

* AC voltage: $f = 50 \text{ Hz}$; $1.4 \times U_{\text{rms}} + U_{\text{DC}} \leq U_r$

** PCM = Printed circuit module = pin spacing.

Dims. in mm.

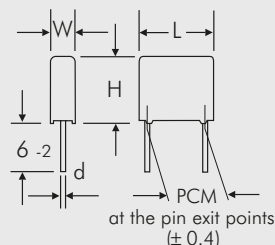

$d = 0.5 \text{ } \varnothing$ if $W = 3$
 $d = 0.6 \text{ } \varnothing$ if $W \geq 4$
 $d = 0.8 \text{ } \varnothing$ if $\text{PCM} = 15$

Part number completion:	
Tolerance:	20 % = M
	10 % = K
	5 % = J
Packing:	bulk = S
Pin length:	6-2 = SD
Taped version see page 157.	

Rights reserved to amend design data without prior notification.

Continuation page 42

Continuation

Impedance change with frequency
(general guide).

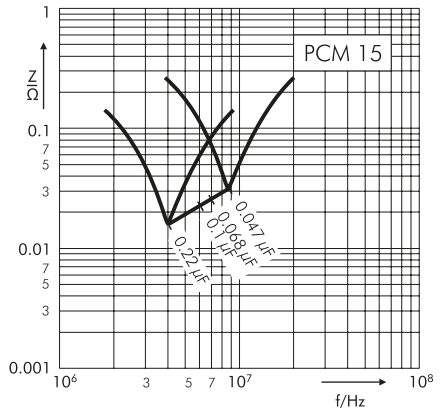
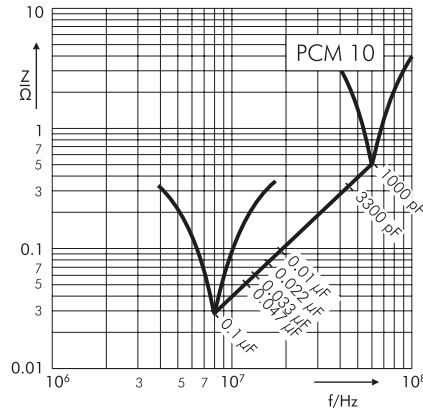
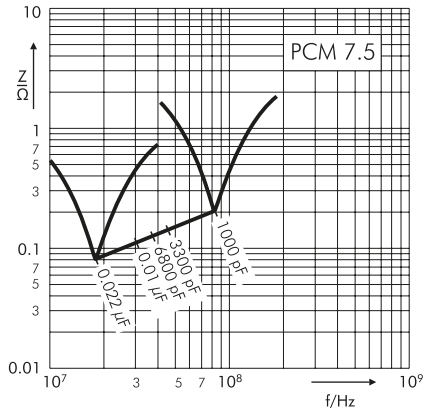

Permissible AC voltage
in relation to frequency
at 10° C internal temperature rise
(general guide).

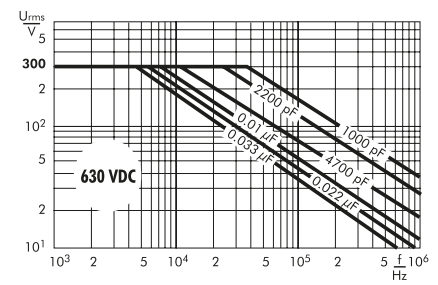
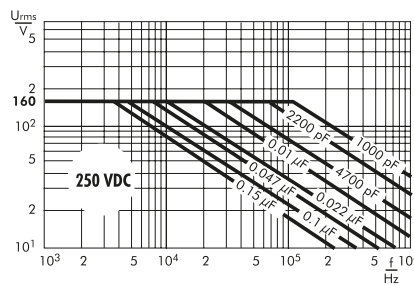
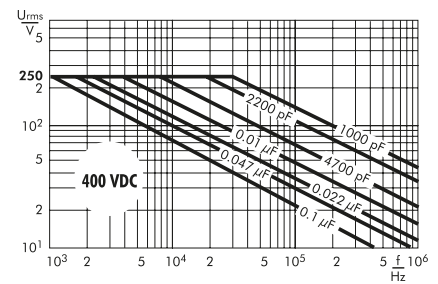
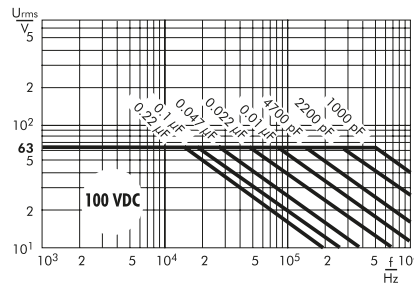

**Polypropylene (PP) Film and Foil Capacitors for Pulse Applications
in PCM 7.5 mm to 15 mm. Capacitances from 100 pF to 0.22 µF.
Rated Voltages from 63 VDC to 1000 VDC.**

Special Features

- Pulse duty construction
- Very low dissipation factor
- Negative capacitance change versus temperature
- Very low dielectric absorption
- According to RoHS 2015/863/EU

Typical Applications

For high frequency applications e.g.

- Sample and hold
- Timing
- LC-Filtering
- Oscillating circuits
- Audio equipment

Construction

Dielectric:

Polypropylene (PP) film

Capacitor electrodes:

Metal foil

Internal construction:

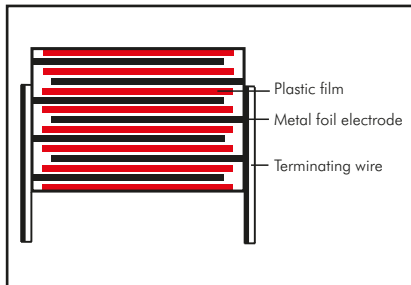

Encapsulation:

Solvent-resistant, flame-retardant plastic case with epoxy resin seal, UL 94 V-0

Terminations:

Tinned wire.

Marking:

Colour: Red. Marking: Black.

Electrical Data

Capacitance range:

100 pF to 0.22 µF (E12-values on request)

Rated voltages:

63 VDC, 100 VDC, 250 VDC, 400 VDC, 630 VDC, 850 VDC, 1000 VDC

Capacitance tolerances:

±20%, ±10%, ±5%

Operating temperature range:

-55° C to +105° C

Test specifications:

In accordance with IEC 60384-13

Climatic test category:

55/100/56 in accordance with IEC

Insulation resistance at +20° C:

≥ 3 x 10⁵ MΩ

Measuring voltage:

U_r = 63 V: U_{test} = 50 V/1 min.

U_r ≥ 100 V: U_{test} = 100 V/1 min.

Test voltage: 2 U_r, 2 sec.

Maximum pulse rise time:

1000 V/µsec.

Dielectric absorption:

0.05 %

Temperature coefficient:

-200 x 10⁻⁶/+ C (general guide)

Dissipation factors at +20° C: tan δ

at f	C ≤ 0.1 µF	0.1 µF < C ≤ 0.22 µF
1 kHz	≤ 5 x 10 ⁻⁴	≤ 5 x 10 ⁻⁴
10 kHz	≤ 6 x 10 ⁻⁴	≤ 6 x 10 ⁻⁴
100 kHz	≤ 8 x 10 ⁻⁴	-

Voltage derating:

A voltage derating factor of 1.35 % per K must be applied from +85° C for DC voltages and from +75° C for AC voltages.

Reliability:

Operational life > 300 000 hours

Failure rate < 5 fit (0.5 x U_r and 40° C)

Mechanical Tests

Pull test on pins:

10 N in direction of pins according to IEC 60068-2-21

Vibration:

6 hours at 10... 2000 Hz and 0.75 mm displacement amplitude or 10 g in accordance with IEC 60068-2-6

Low air density:

1 kPa = 10 mbar in accordance with IEC 60068-2-13

Bump test:

4000 bumps at 390 m/sec² in accordance with IEC 60068-2-29

Packing

Available taped and reeled.

Detailed taping information and graphs at the end of the catalogue.

For further details and graphs please refer to Technical Information.

Continuation

General Data

Capacitance	63 VDC/40 VAC*					100 VDC/63 VAC*				
	W	H	L	PCM**	Part number	W	H	L	PCM**	Part number
100 pF						3	8.5	10	7.5	FKP3D001002B00
150 "						3	8.5	10	7.5	FKP3D001502B00
220 "						3	8.5	10	7.5	FKP3D002202B00
330 "						3	8.5	10	7.5	FKP3D003302B00
470 "						3	8.5	10	7.5	FKP3D004702B00
680 "						3	8.5	10	7.5	FKP3D006802B00
1000 pF						3	8.5	10	7.5	FKP3D011002B00
1500 "						3	8.5	10	7.5	FKP3D011502B00
2200 "						3	8.5	10	7.5	FKP3D012202B00
3300 "						3	8.5	10	7.5	FKP3D013302B00
4700 "						3	8.5	10	7.5	FKP3D014702B00
6800 "						4	9	10	7.5	FKP3D016802C00
0.01 μF						4	9	10	7.5	FKP3D021002C00
0.015 "	4	9	10	7.5	FKP3C021502C00	4	9.5	13	10	FKP3D021503D00
0.022 "	4	9.5	13	10	FKP3C022203D00	5	11	13	10	FKP3D022203F00
0.033 "	4	9.5	13	10	FKP3C023303D00	6	12	13	10	FKP3D023303G00
0.047 "	5	11	13	10	FKP3C024703F00	5	11	18	15	FKP3D024704B00
0.068 "	6	12	13	10	FKP3C026803G00	6	12.5	18	15	FKP3D026804C00
0.1 μF	6	12.5	18	15	FKP3C031004C00	7	14	18	15	FKP3D031004D00
0.15 "	8	15	18	15	FKP3C031504F00	9	16	18	15	FKP3D031504J00
0.22 "	9	16	18	15	FKP3C032204J00					

Capacitance	250 VDC/160 VAC*					400 VDC/250 VAC*				
	W	H	L	PCM**	Part number	W	H	L	PCM**	Part number
100 pF	3	8.5	10	7.5	FKP3F001002B00	3	8.5	10	7.5	FKP3G001002B00
150 "	3	8.5	10	7.5	FKP3F001502B00	3	8.5	10	7.5	FKP3G001502B00
220 "	3	8.5	10	7.5	FKP3F002202B00	3	8.5	10	7.5	FKP3G002202B00
330 "	3	8.5	10	7.5	FKP3F003302B00	3	8.5	10	7.5	FKP3G003302B00
470 "	3	8.5	10	7.5	FKP3F004702B00	3	8.5	10	7.5	FKP3G004702B00
680 "	3	8.5	10	7.5	FKP3F006802B00	3	8.5	10	7.5	FKP3G006802B00
1000 pF	3	8.5	10	7.5	FKP3F011002B00	3	8.5	10	7.5	FKP3G011002B00
1500 "	3	8.5	10	7.5	FKP3F011502B00	4	9	10	7.5	FKP3G011502C00
2200 "	4	9	10	7.5	FKP3F012202C00	4	9	10	7.5	FKP3G012202C00
						4	9.5	13	10	FKP3G012203D00
3300 "	3	9	13	10	FKP3F013303A00	4	9.5	13	10	FKP3G013303D00
4700 "	4	9.5	13	10	FKP3F014703D00	5	11	13	10	FKP3G014703F00
6800 "	5	11	13	10	FKP3F016803F00	6	12	13	10	FKP3G016803G00
0.01 μF	5	11	13	10	FKP3F021003F00	5	11	18	15	FKP3G021004B00
0.015 "	6	12	13	10	FKP3F021503G00	6	12.5	18	15	FKP3G021504C00
0.022 "	6	12.5	18	15	FKP3F022204C00	7	14	18	15	FKP3G022204D00
0.033 "	7	14	18	15	FKP3F023304D00	8	15	18	15	FKP3G023304F00
0.047 "	8	15	18	15	FKP3F024704F00	9	16	18	15	FKP3G024704J00
0.068 "	9	16	18	15	FKP3F026804J00					

* AC voltage: $f \leq 1000 \text{ Hz}$; $1.4 \times U_{\text{rms}} + \text{UDC} \leq U_r$

** PCM = Printed circuit module = pin spacing

Dims. in mm.

$d = 0.5 \text{ } \varnothing$ if $W = 3$ } PCM 7.5 and 10
 $d = 0.6 \text{ } \varnothing$ if $W \geq 4$ }
 $d = 0.8 \text{ } \varnothing$ if PCM = 15

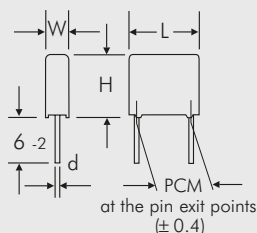

Part number completion:

Tolerance: 20 % = M
 10 % = K
 5 % = J
 Packing: bulk = S
 Pin length: 6-2 = SD
 Taped version see page 157.

Rights reserved to amend design data without prior notification.

Continuation

General Data

Capacitance	630 VDC/300 VAC*					850 VDC/300 VAC*				
	W	H	L	PCM**	Part number	W	H	L	PCM**	Part number
100 pF	3	8.5	10	7.5	FKP3J001002B00	3	8.5	10	7.5	FKP3M001002B00
150 "	3	8.5	10	7.5	FKP3J001502B00	3	8.5	10	7.5	FKP3M001502B00
220 "	3	8.5	10	7.5	FKP3J002202B00	3	8.5	10	7.5	FKP3M002202B00
330 "	3	8.5	10	7.5	FKP3J003302B00	3	8.5	10	7.5	FKP3M003302B00
470 "	3	8.5	10	7.5	FKP3J004702B00	3	8.5	10	7.5	FKP3M004702B00
680 "	3	8.5	10	7.5	FKP3J006802B00	3	8.5	10	7.5	FKP3M006802B00
1000 pF	4	9	10	7.5	FKP3J011002C00	4	9	10	7.5	FKP3M011002C00
1500 "	4	9.5	13	10	FKP3J011503D00	4	9.5	13	10	FKP3M011503D00
2200 "	4	9.5	13	10	FKP3J012203D00	4	9.5	13	10	FKP3M012203D00
3300 "	5	11	13	10	FKP3J013303F00	5	11	13	10	FKP3M013303F00
4700 "	6	12	13	10	FKP3J014703G00	6	12	13	10	FKP3M014703G00
6800 "	5	11	18	15	FKP3J016804B00	5	11	18	15	FKP3M016804B00
0.01 µF	6	12.5	18	15	FKP3J021004C00	6	12.5	18	15	FKP3M021004C00
0.015 "	8	15	18	15	FKP3J021504F00	8	15	18	15	FKP3M021504F00
0.022 "	9	16	18	15	FKP3J022204J00	9	16	18	15	FKP3M022204J00
0.033 "	9	16	18	15	FKP3J023304J00					

Capacitance	1000 VDC/300 VAC*				
	W	H	L	PCM**	Part number
100 pF	3	8.5	10	7.5	FKP3O101002B00
150 "	3	8.5	10	7.5	FKP3O101502B00
220 "	3	8.5	10	7.5	FKP3O102202B00
330 "	3	8.5	10	7.5	FKP3O103302B00
470 "	3	8.5	10	7.5	FKP3O104702B00
680 "	3	8.5	10	7.5	FKP3O106802B00
1000 pF	4	9	10	7.5	FKP3O111002C00
1500 "	4	9.5	13	10	FKP3O111503D00
2200 "	4	9.5	13	10	FKP3O112203D00
3300 "	5	11	13	10	FKP3O113303F00
4700 "	6	12	13	10	FKP3O114703G00
6800 "	5	11	18	15	FKP3O116804B00
0.01 µF	6	12.5	18	15	FKP3O121004C00
0.015 "	8	15	18	15	FKP3O121504F00
0.022 "	9	16	18	15	FKP3O122204J00

Part number completion:

Tolerance: 20 % = M
10 % = K
5 % = J

Packing: bulk = S
Pin length: 6-2 = SD

Taped version see page 157.

* AC voltage: $f \leq 1000 \text{ Hz}$; $1.4 \times U_{\text{rms}} + \text{UDC} \leq U_r$

** PCM = Printed circuit module = pin spacing

Dims. in mm.

$d = 0.5 \text{ } \varnothing$ if $W = 3$ } PCM 7.5 and 10
 $d = 0.6 \text{ } \varnothing$ if $W \geq 4$ }
 $d = 0.8 \text{ } \varnothing$ if PCM = 15

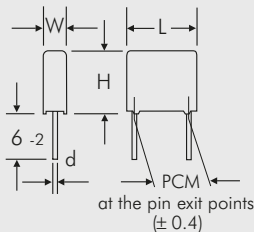

Rights reserved to amend design data without prior notification.

Continuation page 46

Continuation

Impedance change with frequency
(general guide).

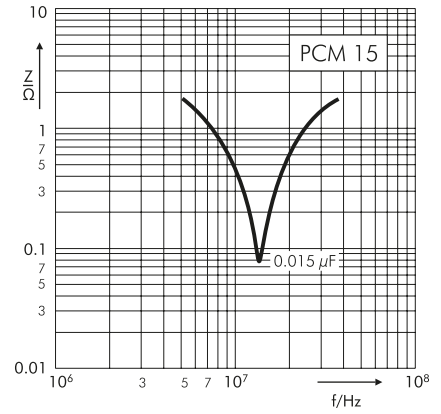
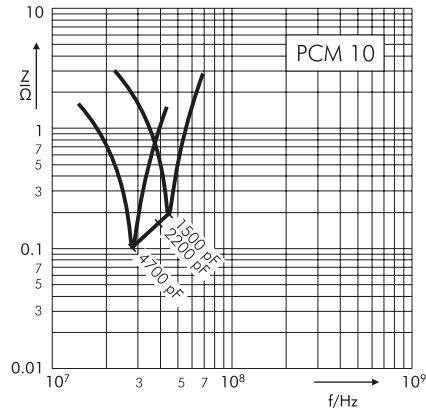
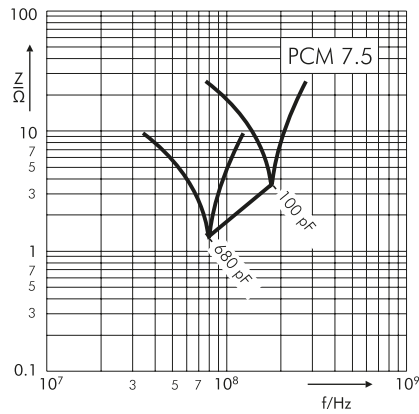

Permissible AC voltage
in relation to frequency
at 10° C internal temperature rise
(general guide).

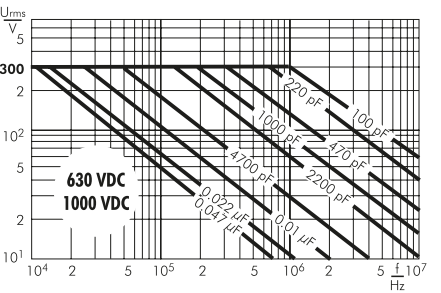
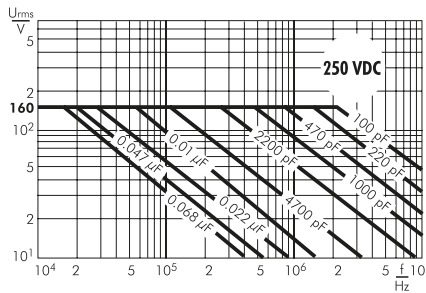
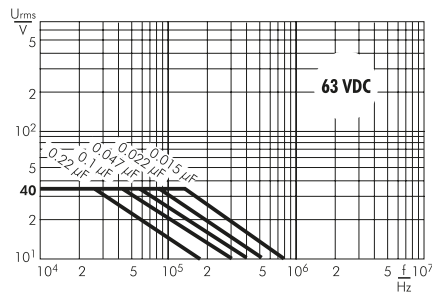
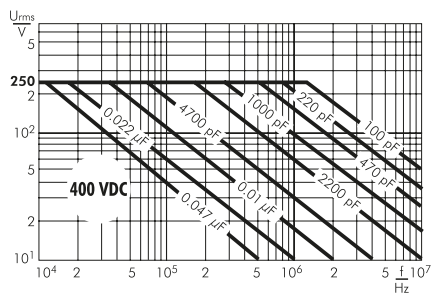
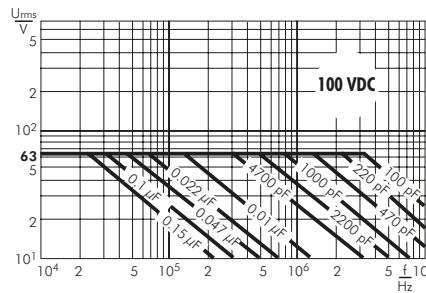

WIMA Capacitors with Metallized, Self-Healing Construction PCM 5 to 52.5 mm

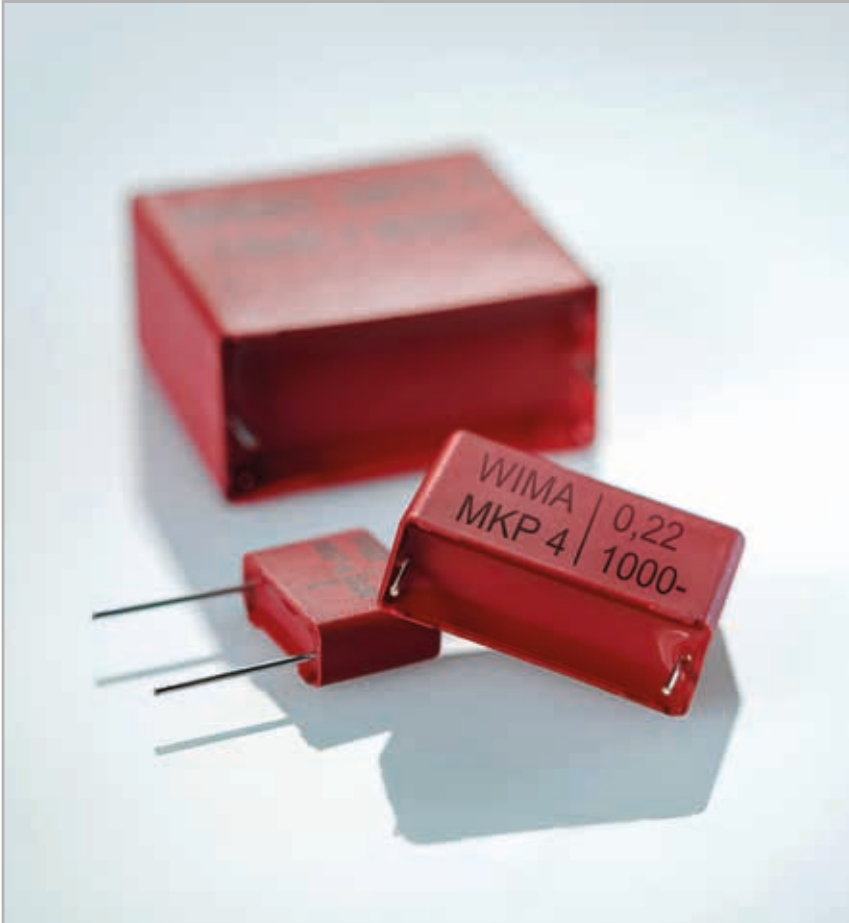

WIMA MKS 2

WIMA MKP 2

WIMA MKS 4

WIMA MKP 4

In the case of metallized capacitors, thin layers of aluminium (approx. 0.03 mm) are vacuum-deposited on the insulating film as conducting electrodes. In the case of a breakdown, the short circuit current causes the thin metal coating to evaporate around the point of failure and an insulating area is formed. The capacitor remains intact (self-healing). Due to their construction principle metallized capacitors stand out for their very favourable capacitance/volume ratio.

Metallized WIMA capacitors in PCM 5 mm – 52.5 mm are available in two dielectric versions.

Capacitors with a Polyester dielectric (PET) are suitable for general applications such

as coupling, decoupling and by-passing. By making use of ultra thin film and appropriate manufacturing experience, it has been possible to achieve high capacitance values in very small box sizes. The WIMA MKS 2 for example is available with capacitance values up to 10 μF in PCM 5 mm whereas the MKS 4 is offering capacitances up to 680 μF in PCM 52.5 mm.

Polypropylene capacitors (PP) are used in the high frequency field. This includes resonant circuits, power supplies, deflection circuits, oscillator circuits and audio equipment. WIMA metallized Polypropylene capacitors in PCM 5 - 37.5 mm are available with capacitance values up to 68 μF and voltage ratings up to 1250 VDC.

Upon customer request, larger box sizes can be supplied in 4-pin versions. Types with terminating plates can also be manufactured on request. The advantage of this method of construction, besides the improved mechanical stability of the component on the board, is the excellent electrical contact reliability.

WIMA capacitors are produced with the proven box technology using solvent-resistant, flame-retardant plastic cases according to UL 94 V-0. They are environmentally compatible with the RoHS 2015/863/EU regulations of the European Union.



Metallized Polyester (PET) Capacitors in PCM 5 mm.
Capacitances from 0.01 µF to 10 µF. Rated Voltages from 50 VDC to 630 VDC.

Special Features

- High volume/capacitance ratio
- Self-healing
- AEC-Q200 qualified
- According to RoHS 2015/863/EU

Typical Applications

For general DC-applications e.g.

- By-pass
- Blocking
- Coupling and decoupling
- Timing

Construction

Dielectric:

Polyethylene-terephthalate (PET) film

Capacitor electrodes:

Vacuum-deposited

Internal construction:

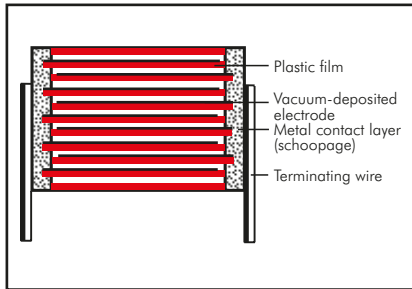

Encapsulation:

Solvent-resistant, flame-retardant plastic case with epoxy resin seal, UL 94 V-0

Terminations:

Tinned wire.

Marking: Colour: Red.

Marking: Black.

Electrical Data

Capacitance range:

0.01 µF to 10 µF (E12-values on request)

Rated voltages:

50 VDC, 63 VDC, 100 VDC, 250 VDC, 400 VDC, 630 VDC

Capacitance tolerances:

±20%, ±10%, ±5%

Operating temperature range:

$U_r = 50$ VDC: -55° C to +105° C

$U_r \geq 63$ VDC: -55° C to +125° C

Climatic test category:

55/100/21 in accordance with IEC

Insulation resistance at +20° C:

U_r	U_{test}	$C \leq 0.33 \mu F$	$0.33 \mu F < C \leq 10 \mu F$
50 VDC	10 V	$\geq 5 \times 10^3 M\Omega$	$\geq 1000 \text{ sec } (M\Omega \times \mu F)$
63 VDC	50 V	$\geq 1 \times 10^4 M\Omega$	$\geq 1250 \text{ sec } (M\Omega \times \mu F)$
≥ 100 VDC	100 V	$\geq 1.5 \times 10^4 M\Omega$	$\geq 3000 \text{ sec } (M\Omega \times \mu F)$

Measuring time: 1 min.

Dissipation factors at +20° C: $\tan \delta$

at f	$C \leq 0.1 \mu F$	$0.1 \mu F < C \leq 1.0 \mu F$	$C > 1.0 \mu F$
1 kHz	$\leq 8 \times 10^{-3}$	$\leq 8 \times 10^{-3}$	$\leq 10 \times 10^{-3}$
10 kHz	$\leq 15 \times 10^{-3}$	$\leq 15 \times 10^{-3}$	-
100 kHz	$\leq 30 \times 10^{-3}$	-	-

Maximum pulse rise time:

Capacitance µF	max. pulse rise time V/µsec					
	50 VDC	63 VDC	100 VDC	250 VDC	400 VDC	630 VDC
0.01 ... 0.022	-	35	35	50	80	110
0.033 ... 0.068	-	20	25	50	80	90
0.1 ... 0.47	10	15	20	50	80	-
0.68 ... 1.0	8	12	15	25	-	-
1.5 ... 3.3	8	7.5	10	-	-	-
4.7	5	5	-	-	-	-
6.8	3	3	-	-	-	-
10	2.5	-	-	-	-	-

Mechanical Tests

Pull test on pins:

10 N in direction of pins according to IEC 60068-2-21

Vibration:

6 hours at 10...2000 Hz and 0.75 mm displacement amplitude or 10 g in accordance with IEC 60068-2-6

Low air density:

1 kPa = 10 mbar in accordance with IEC 60068-2-13

Bump test:

4000 bumps at 390 m/sec² in accordance with IEC 60068-2-29

Packing

Available taped and reeled.

Detailed taping information and graphs at the end of the catalogue.

For further details and graphs please refer to Technical Information.

Continuation

General Data

Capacitance	50 VDC/30 VAC*					63 VDC/40 VAC*				
	W	H	L	PCM**	Part number	W	H	L	PCM**	Part number
0.01 μ F						2.5	6.5	7.2	5	MKS2C021001A00
0.015 "						2.5	6.5	7.2	5	MKS2C021501A00
0.022 "						2.5	6.5	7.2	5	MKS2C022201A00
0.033 "						2.5	6.5	7.2	5	MKS2C023301A00
0.047 "						2.5	6.5	7.2	5	MKS2C024701A00
0.068 "						2.5	6.5	7.2	5	MKS2C026801A00
0.1 μ F						2.5	6.5	7.2	5	MKS2C031001A00
0.15 "						2.5	6.5	7.2	5	MKS2C031501A00
0.22 "						3	7.5	7.2	5	MKS2C032201B00
0.33 "	2.5	6.5	7.2	5	MKS2B033301A00	3.5	8.5	7.2	5	MKS2C033301C00
0.47 "	3	7.5	7.2	5	MKS2B034701B00	3.5	8.5	7.2	5	MKS2C034701C00
0.68 "	3.5	8.5	7.2	5	MKS2B036801C00	4.5	9.5	7.2	5	MKS2C036801E00
1.0 μ F	3.5	8.5	7.2	5	MKS2B041001C00	5	10	7.2	5	MKS2C041001F00
1.5 "	4.5	9.5	7.2	5	MKS2B041501E00	5.5	11.5	7.2	5	MKS2C041501H00
2.2 "	5	10	7.2	5	MKS2B042201F00	7.2	13	7.2	5	MKS2C042201K00
3.3 "	5.5	11.5	7.2	5	MKS2B043301H00	7.2	13	7.2	5	MKS2C043301K00
4.7 "	7.2	13	7.2	5	MKS2B044701K00	8.5	14	7.2	5	MKS2C044701M00
6.8 "	8.5	14	7.2	5	MKS2B046801M00	11	16	7.2	5	MKS2C046801N00
10 μ F	11	16	7.2	5	MKS2B051001N00					

Capacitance	100 VDC/63 VAC*					250 VDC/160 VAC*				
	W	H	L	PCM**	Part number	W	H	L	PCM**	Part number
0.01 μ F	2.5	6.5	7.2	5	MKS2D021001A00	2.5	6.5	7.2	5	MKS2F021001A00
0.015 "	2.5	6.5	7.2	5	MKS2D021501A00	2.5	6.5	7.2	5	MKS2F021501A00
0.022 "	2.5	6.5	7.2	5	MKS2D022201A00	2.5	6.5	7.2	5	MKS2F022201A00
0.033 "	2.5	6.5	7.2	5	MKS2D023301A00	3.5	8.5	7.2	5	MKS2F023301C00
0.047 "	2.5	6.5	7.2	5	MKS2D024701A00	3.5	8.5	7.2	5	MKS2F024701C00
0.068 "	2.5	6.5	7.2	5	MKS2D026801A00	3.5	8.5	7.2	5	MKS2F026801C00
0.1 μ F	2.5	6.5	7.2	5	MKS2D031001A00	4.5	9.5	7.2	5	MKS2F031001E00
0.15 "	3.5	8.5	7.2	5	MKS2D031501C00	5	10	7.2	5	MKS2F031501F00
0.22 "	3.5	8.5	7.2	5	MKS2D032201C00	5.5	11.5	7.2	5	MKS2F032201H00
0.33 "	4.5	9.5	7.2	5	MKS2D033301E00	7.2	13	7.2	5	MKS2F033301K00
0.47 "	4.5	9.5	7.2	5	MKS2D034701E00	8.5	14	7.2	5	MKS2F034701M00
0.68 "	5	10	7.2	5	MKS2D036801F00	11	16	7.2	5	MKS2F036801N00
1.0 μ F	7.2	13	7.2	5	MKS2D041001K00					
1.5 "	8.5	14	7.2	5	MKS2D041501M00					
2.2 "	11	16	7.2	5	MKS2D042201N00					

* AC voltage: $f = 50 \text{ Hz}$; $1.4 \times U_{\text{rms}} + \text{UDC} \leq U_r$

** PCM = Printed circuit module = pin spacing.

Dims. in mm.

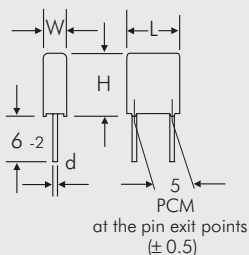

Part number completion:

Tolerance: 20 % = M

10 % = K

5 % = J

Packing: bulk = S

Pin length: 6-2 = SD

Taped version see page 157.

Rights reserved to amend design data without prior notification.

Continuation page 50

Continuation

General Data

Capacitance	400 VDC/200 VAC*					630 VDC/220 VAC*				
	W	H	L	PCM**	Part number	W	H	L	PCM**	Part number
0.01 μF	2.5	6.5	7.2	5	MKS2G021001A00	5.5	11.5	7.2	5	MKS2J021001H00
0.015 "	2.5	6.5	7.2	5	MKS2G021501A00	7.2	13	7.2	5	MKS2J021501K00
0.022 "	3.5	8.5	7.2	5	MKS2G022201C00	7.2	13	7.2	5	MKS2J022201K00
0.033 "	4.5	9.5	7.2	5	MKS2G023301E00	7.2	13	7.2	5	MKS2J023301K00
0.047 "	4.5	9.5	7.2	5	MKS2G024701E00	8.5	14	7.2	5	MKS2J024701M00
0.068 "	5.5	11.5	7.2	5	MKS2G026801H00					
0.1 μF	7.2	13	7.2	5	MKS2G031001K00					
0.15 "	8.5	14	7.2	5	MKS2G031501M00					
0.22 "	11	16	7.2	5	MKS2G032201N00					

* AC voltage: $f = 50 \text{ Hz}$; $1.4 \times U_{\text{rms}} + \text{UDC} \leq U_r$

** PCM = Printed circuit module = pin spacing.

Dims. in mm.

Part number completion:

Tolerance: 20 % = M

10 % = K

5 % = J

Packing: bulk = S

Pin length: 6-2 = SD

Taped version see page 157.

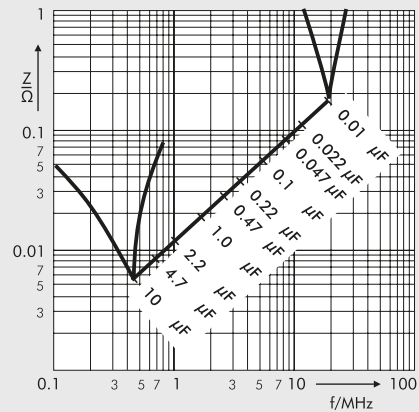

Impedance change with frequency (general guide).

Rights reserved to amend design data without prior notification.

Permissible AC voltage in relation to frequency at 10° C internal temperature rise (general guide).

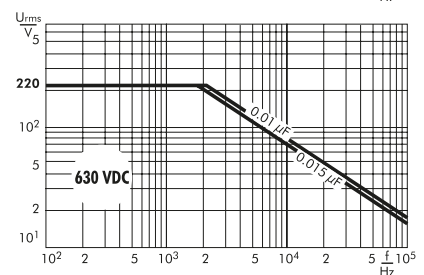
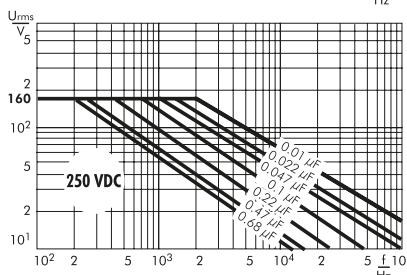
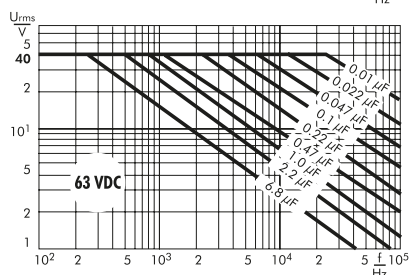
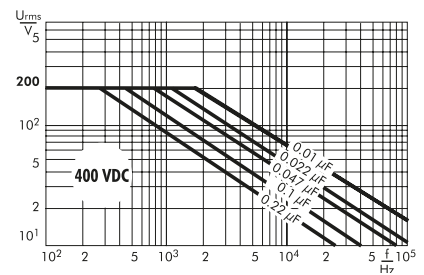
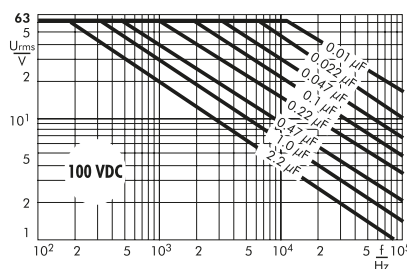
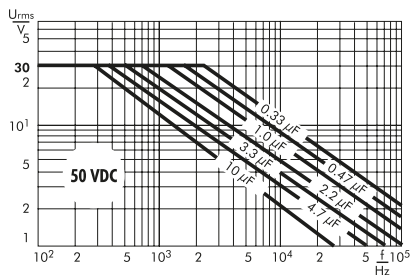

**Metallized Polypropylene (PP) Capacitors in PCM 5 mm.
Capacitances from 1000 pF to 1.0 μF. Rated Voltages from 63 VDC to 1000 VDC.**

Special Features

- High volume/capacitance ratio
- Self-healing
- Increased pulse duty from 250 VDC rated voltage
- Very low dissipation factor
- Negative capacitance change versus temperature
- Very low dielectric absorption
- AEC-Q200 qualified AEC-Q200
- According to RoHS 2015/863/EU

Typical Applications

For high frequency applications e.g.

- Sample and hold
- Timing
- Oscillating circuits
- High frequency coupling and decoupling

Construction

Dielectric:

Polypropylene (PP) film

Capacitor electrodes:

Vacuum-deposited

Internal construction:

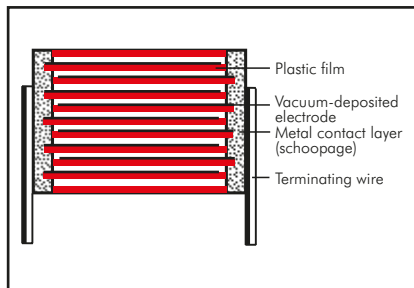

Encapsulation:

Solvent-resistant, flame-retardant plastic case with epoxy resin seal, UL 94 V-0

Terminations:

Tinned wire.

Marking:

Colour: Red. Marking: Black.

Electrical Data

Capacitance range:

1000 pF to 1.0 μF (E12-values on request)

Rated voltages:

63 VDC, 100 VDC, 250 VDC, 400 VDC, 630 VDC, 800 VDC, 1000 VDC

Capacitance tolerances:

± 20%, ± 10%, ± 5%

Operating temperature range:

-55° C to +100° C

Test specifications:

In accordance with IEC 60384-16

Climatic test category:

55/100/56 in accordance with IEC

Insulation resistance at +20° C:

≥ 1 x 10⁵ MΩ

Measuring voltage:

U_r = 63 V: U_{test} = 50 V/1 min.

U_r ≥ 100 V: U_{test} = 100 V/1 min.

Test voltage:

1.6 U_r, 2 sec.

Maximum pulse rise time:

Capacitance pF/μF	max. pulse rise time V/μsec						
	63 VDC	100 VDC	250 VDC	400 VDC	630 VDC	800 VDC	1000 VDC
1000 ... 2200	–	–	–	300	400	450	500
3300 ... 6800	–	–	–	300	400	450	500
0.01 ... 0.022	100	100	250	300	400	450	500
0.033 ... 0.068	100	100	250	300	400	450	–
0.1 ... 0.22	100	100	250	250	–	–	–
0,33 ... 0.68	100	100	250	–	–	–	–
1.0	70	70	–	–	–	–	–

Dielectric absorption:

0.05 %

Dissipation factors at +20° C: tan δ

at f	C ≤ 0.1 μF	0.1 μF < C ≤ 1.0 μF
1 kHz	≤ 5 x 10 ⁻⁴	≤ 5 x 10 ⁻⁴
10 kHz	≤ 8 x 10 ⁻⁴	≤ 8 x 10 ⁻⁴
100 kHz	≤ 25 x 10 ⁻⁴	–

Voltage derating:

A voltage derating factor of 1.35 % per K must be applied from +85° C for DC voltages and from +75° C for AC voltages

Reliability:

Operational life > 300 000 hours

Failure rate < 2 fit (0.5 x U_r and 40° C)

Mechanical Tests

Pull test on pins:

10 N in direction of pins according to IEC 60068-2-21

Vibration:

6 hours at 10 ... 2000 Hz and 0.75 mm displacement amplitude or 10 g in accordance with IEC 60068-2-6

Low air density:

1 kPa = 10 mbar in accordance with IEC 60068-2-13

Bump test:

4000 bumps at 390 m/sec² in accordance with IEC 60068-2-29

Packing

Available taped and reeled.

Detailed taping information and graphs at the end of the catalogue.

For further details and graphs please refer to Technical Information.

Continuation

General Data

Capacitance	63 VDC/40 VAC*					100 VDC/63 VAC*				
	W	H	L	PCM**	Part number	W	H	L	PCM**	Part number
0.01 µF	3	7.5	7.2	5	MKP2C021001B00	3	7.5	7.2	5	MKP2D021001B00
0.015 "	3	7.5	7.2	5	MKP2C021501B00	3	7.5	7.2	5	MKP2D021501B00
0.022 "	3	7.5	7.2	5	MKP2C022201B00	3	7.5	7.2	5	MKP2D022201B00
0.033 "	3	7.5	7.2	5	MKP2C023301B00	3	7.5	7.2	5	MKP2D023301B00
0.047 "	3.5	8.5	7.2	5	MKP2C024701C00	3.5	8.5	7.2	5	MKP2D024701C00
0.068 "	4.5	9.5	7.2	5	MKP2C026801E00	4.5	9.5	7.2	5	MKP2D026801E00
0.1 µF	5	10	7.2	5	MKP2C031001F00	5	10	7.2	5	MKP2D031001F00
0.15 "	5.5	11.5	7.2	5	MKP2C031501H00	5.5	11.5	7.2	5	MKP2D031501H00
0.22 "	7.2	13	7.2	5	MKP2C032201K00	7.2	13	7.2	5	MKP2D032201K00
0.33 "	8.5	14	7.2	5	MKP2C033301M00	8.5	14	7.2	5	MKP2D033301M00
0.47 "	8.5	14	7.2	5	MKP2C034701M00	8.5	14	7.2	5	MKP2D034701M00
0.68 "	8.5	14	7.2	5	MKP2C036801M00	8.5	14	7.2	5	MKP2D036801M00
1.0 µF	11	16	7.2	5	MKP2C041001N00	11	16	7.2	5	MKP2D041001N00

Capacitance	250 VDC/160 VAC*					400 VDC/200 VAC*				
	W	H	L	PCM**	Part number	W	H	L	PCM**	Part number
1000 pF						3	7.5	7.2	5	MKP2G011001B00
1500 "						3	7.5	7.2	5	MKP2G011501B00
2200 "						3	7.5	7.2	5	MKP2G012201B00
3300 "						3	7.5	7.2	5	MKP2G013301B00
4700 "						3	7.5	7.2	5	MKP2G014701B00
6800 "						3	7.5	7.2	5	MKP2G016801B00
0.01 µF	3	7.5	7.2	5	MKP2F021001B00	3.5	8.5	7.2	5	MKP2G021001C00
0.015 "	3	7.5	7.2	5	MKP2F021501B00	3.5	8.5	7.2	5	MKP2G021501C00
0.022 "	3	7.5	7.2	5	MKP2F022201B00	4.5	9.5	7.2	5	MKP2G022201E00
0.033 "	3	7.5	7.2	5	MKP2F023301B00	5.5	11.5	7.2	5	MKP2G023301H00
0.047 "	3.5	8.5	7.2	5	MKP2F024701C00	7.2	13	7.2	5	MKP2G024701K00
0.068 "	4.5	9.5	7.2	5	MKP2F026801E00	7.2	13	7.2	5	MKP2G026801K00
0.1 µF	5	10	7.2	5	MKP2F031001F00	8.5	14	7.2	5	MKP2G031001M00
0.15 "	7.2	13	7.2	5	MKP2F031501K00	11	16	7.2	5	MKP2G031501N00
0.22 "	7.2	13	7.2	5	MKP2F032201K00					
0.33 "	8.5	14	7.2	5	MKP2F033301M00					
0.47 "	11	16	7.2	5	MKP2F034701N00					

Capacitance	630 VDC/250 VAC*				
	W	H	L	PCM**	Part number
1000 pF	3	7.5	7.2	5	MKP2J011001B00
1500 "	3	7.5	7.2	5	MKP2J011501B00
2200 "	3	7.5	7.2	5	MKP2J012201B00
3300 "	3	7.5	7.2	5	MKP2J013301B00
4700 "	3	7.5	7.2	5	MKP2J014701B00
6800 "	3.5	8.5	7.2	5	MKP2J016801C00
0.01 µF	4.5	9.5	7.2	5	MKP2J021001E00
0.015 "	5	10	7.2	5	MKP2J021501F00
0.022 "	5.5	11.5	7.2	5	MKP2J022201H00
0.033 "	7.2	13	7.2	5	MKP2J023301K00
0.047 "	8.5	14	7.2	5	MKP2J024701M00
0.068 "	11	16	7.2	5	MKP2J026801N00

** PCM = Printed circuit module = pin spacing.

Dims. in mm.

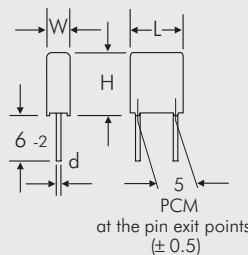

Part number completion:	
Tolerance:	20 % = M
	10 % = K
	5 % = J
Packing:	bulk = S
Pin length:	6-2 = SD
Taped version see page 157.	

$$d = 0.5 \varnothing$$

* AC voltage: $f \leq 400 \text{ Hz}$; $1.4 \times U_{\text{rms}} + U_{\text{DC}} \leq U_{\text{r}}$

Rights reserved to amend design data without prior notification.

Continuation

General Data

Capacitance	800 VDC/250 VAC*					1000 VDC/250 VAC*				
	W	H	L	PCM**	Part number	W	H	L	PCM**	Part number
1000 pF	3	7.5	7.2	5	MKP2L011001B00	3	7.5	7.2	5	MKP2O111001B00
1500 "	3	7.5	7.2	5	MKP2L011501B00	3	7.5	7.2	5	MKP2O111501B00
2200 "	3	7.5	7.2	5	MKP2L012201B00	3	7.5	7.2	5	MKP2O112201B00
3300 "	3	7.5	7.2	5	MKP2L013301B00	3.5	8.5	7.2	5	MKP2O113301C00
4700 "	3.5	8.5	7.2	5	MKP2L014701C00	4.5	9.5	7.2	5	MKP2O114701E00
6800 "	4.5	9.5	7.2	5	MKP2L016801E00	5	10	7.2	5	MKP2O116801F00
0.01 μF	5	10	7.2	5	MKP2L021001F00	7.2	13	7.2	5	MKP2O121001K00
0.015 "	5.5	11.5	7.2	5	MKP2L021501H00	8.5	14	7.2	5	MKP2O121501M00
0.022 "	7.2	13	7.2	5	MKP2L022201K00	11	16	7.2	5	MKP2O122201N00
0.033 "	8.5	14	7.2	5	MKP2L023301M00					
0.047 "	11	16	7.2	5	MKP2L024701N00					

* AC voltage: $f \leq 400 \text{ Hz}$; $1.4 \times U_{\text{rms}} + \text{UDC} \leq U_r$

** PCM = printed circuit module = pin spacing.

Dims. in mm.

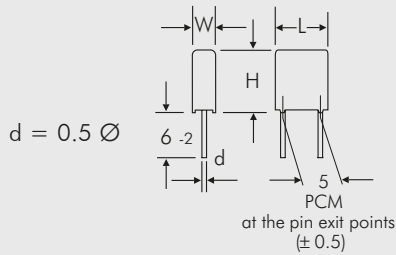

Part number completion:
 Tolerance: 20 % = M
 10 % = K
 5 % = J
 Packing: bulk = S
 Pin length: 6-2 = SD
 Taped version see page 157.

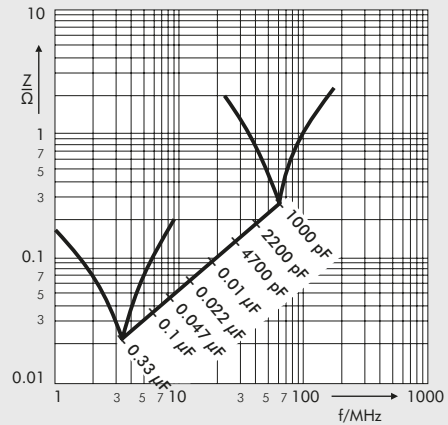

Impedance change with frequency (general guide).

Rights reserved to amend design data without prior notification.

Permissible AC voltage in relation to frequency at 10° C internal temperature rise (general guide).

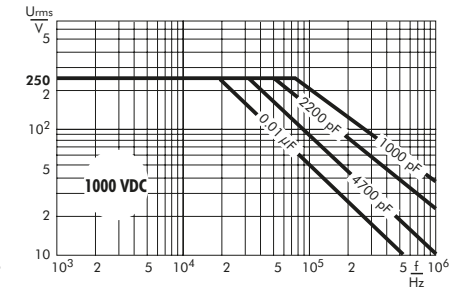
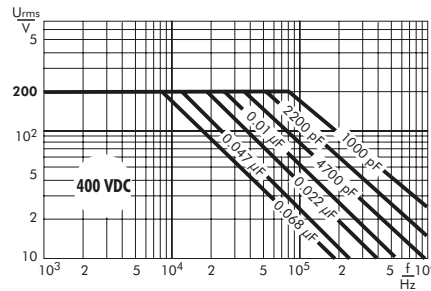
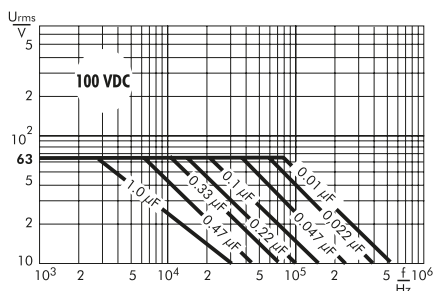
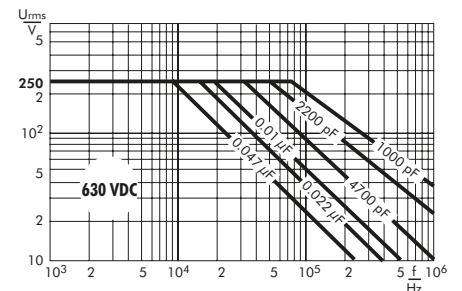
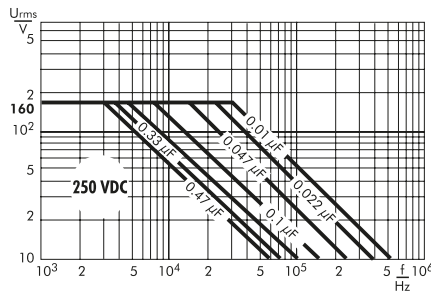
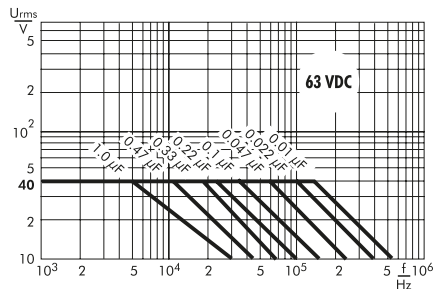

Metallized Polyester (PET) Capacitors
in PCM 7.5 mm to 52.5 mm. Capacitances from 1000 pF to 680 µF.
Rated Voltages from 50 VDC to 2000 VDC.

Special Features

- High volume/capacitance ratio
- Self-healing
- AEC-Q200 qualified
- According to RoHS 2015/863/EU

Typical Applications

For general DC-applications e.g.

- By-pass
- Blocking
- Coupling and decoupling
- Smoothing
- Timing

Construction

Dielectric:

Polyethylene-terephthalate (PET) film

Capacitor electrodes:

Vacuum-deposited

Internal construction:

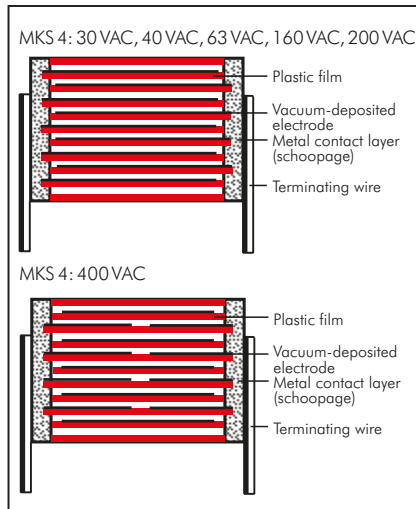

Encapsulation:

Solvent-resistant, flame-retardant plastic case with epoxy resin seal, UL 94 V-0

Terminations:

Tinned wire.

Marking:

Colour: Red. Marking: Black.

Electrical Data

Capacitance range:

1000 pF to 680 µF

Rated voltages:

50VDC, 63VDC, 100VDC, 250VDC, 400VDC, 630 VDC, 1000 VDC, 1500 VDC, 2000 VDC

Capacitance tolerances:

± 20%, ± 10% ± 5%

Operating temperature range:

$U_r = 50$ VDC: -55° C to +105° C

$U_r \geq 63$ VDC: -55° C to +125° C

Climatic test category:

55/100/56 in accordance with IEC

Insulation resistance at +20° C:

U_r	U_{test}	$C \leq 0.33 \mu F$	$0.33 \mu F < C \leq 680 \mu F$
50VDC	10V	$\geq 5 \times 10^3 M\Omega$	$\geq 1500 \text{ sec } (M\Omega \times \mu F)$
63VDC	50V	$\geq 1 \times 10^4 M\Omega$	$\geq 3000 \text{ sec } (M\Omega \times \mu F)$
100VDC	100V	$\geq 1.5 \times 10^4 M\Omega$	$\geq 5000 \text{ sec } (M\Omega \times \mu F)$
≥ 250 VDC	100V	$\geq 3 \times 10^4 M\Omega$	$\geq 10000 \text{ sec } (M\Omega \times \mu F)$

Measuring time: 1 min.

Dissipation factors at + 20° C: $\tan \delta$

at f	$C \leq 0.1 \mu F$	$0.1 \mu F < C \leq 1.0 \mu F$	$C > 1.0 \mu F$
1 kHz	$\leq 8 \times 10^{-3}$	$\leq 8 \times 10^{-3}$	$\leq 10 \times 10^{-3}$
10 kHz	$\leq 15 \times 10^{-3}$	$\leq 15 \times 10^{-3}$	-
100 kHz	$\leq 30 \times 10^{-3}$	-	-

Maximum pulse rise time:

Capacitance pF/µF	max. pulse rise time V/µsec								
	50VDC	63VDC	100VDC	250VDC	400VDC	630VDC	1000VDC	1500VDC	2000VDC
1000 ...6800	-	-	-	-	-	-	70	90	100
0.01 ...0.022	-	-	30	35	38	40	50	50	60
0.033...0.068	-	-	15	20	25	32	26	35	40
0.1 ...0.22	10	10	12	15	15	17	20	35	40
0.33 ...0.68	9	9	9	10	10	13	20	20	38
1.0 ...2.2	6	6	5	6	9	13	14	15	15
3.3 ...6.8	2.5	3	3	6	6	9	12	12	12
10 ...22	2.5	2.5	2.5	3	6	6	6	-	-
33 ...68	2.5	2.5	2.5	3	3	-	-	-	-
100 ...220	2.5	2.5	2.5	0.9	-	-	-	-	-
330 ...680	0.2	0.2	0.3	-	-	-	-	-	-

Mechanical Tests

Pull test on pins:

$d \leq 0.8 \text{ } \varnothing$: 10 N in direction of pins

$d > 0.8 \text{ } \varnothing$: 20 N in direction of pins

according to IEC 60068-2-21

Vibration:

6 hours at 10... 2000 Hz and

0.75 mm displacement amplitude or 10 g

in accordance with IEC 60068-2-6

Low air density:

1 kPa = 10 mbar in

accordance with IEC 60068-2-13

Bump test:

4000 bumps at 390 m/sec²

in accordance with IEC 60068-2-29

Packing

Available taped and reeled up to and including case size 15 x 26 x 31.5 / PCM 27.5 mm.

Detailed taping information and graphs at the end of the catalogue.

For further details and graphs please refer to Technical Information.

Continuation

General Data

Capacitance	50 VDC/30 VAC*					63 VDC/40 VAC*				
	W	H	L	PCM**	Part number	W	H	L	PCM**	Part number
0.1 µF	2.5	7	10	7.5	MKS4B031002A	2.5	7	10	7.5	MKS4C031002A
						4	9	13	10	MKS4C031003C
0.15 "	2.5	7	10	7.5	MKS4B031502A	2.5	7	10	7.5	MKS4C031502A
						4	9	13	10	MKS4C031503C
0.22 "	2.5	7	10	7.5	MKS4B032202A	3	8.5	10	7.5	MKS4C032202B
						4	9	13	10	MKS4C032203C
0.33 "	2.5	7	10	7.5	MKS4B033302A	4	9	10	7.5	MKS4C033302C
						4	9	13	10	MKS4C033303C
0.47 "	3	8.5	10	7.5	MKS4B034702B	4	9	10	7.5	MKS4C034702C
						4	9	13	10	MKS4C034703C
0.68 "	4	9	10	7.5	MKS4B036802C	5	10.5	10.3	7.5	MKS4C036802E
						4	9	13	10	MKS4C036803C
1.0 µF	4	9	10	7.5	MKS4B041002C	5	10.5	10.3	7.5	MKS4C041002E
						4	9	13	10	MKS4C041003C
1.5 "	5	10.5	10.3	7.5	MKS4B041502E	5.7	12.5	10.3	7.5	MKS4C041502F
						5	11	13	10	MKS4C041503F
2.2 "	5.7	12.5	10.3	7.5	MKS4B042202F	5	11	13	10	MKS4C042203F
						6	12.5	18	15	MKS4C042204C
3.3 "	5.7	12.5	10.3	7.5	MKS4B043302F	6	12	13	10	MKS4C043303G
						7	14	18	15	MKS4C043304D
4.7 "	7.2	12.5	10.3	7.5	MKS4B044702G	7	14	18	15	MKS4C044704D
	6	12	13	10	MKS4B044703G	6	15	26.5	22.5	MKS4C044705B
6.8 "	7.2	12.5	10.3	7.5	MKS4B046802G	8	15	18	15	MKS4C046804F
	6	12	13	10	MKS4B046803G	7	16.5	26.5	22.5	MKS4C046805D
10 µF	9	16	18	15	MKS4B051004J	8.5	18.5	26.5	22.5	MKS4C051005F
						9	19	31.5	27.5	MKS4C051006A
15 "	11	21	26.5	22.5	MKS4B051505I	11	21	26.5	22.5	MKS4C051505I
						9	19	31.5	27.5	MKS4C051506A
18 "	9	19	31.5	27.5	MKS4B051806A	9	19	31.5	27.5	MKS4C051806A
22 "	11	21	31.5	27.5	MKS4B052206B	11	21	31.5	27.5	MKS4C052206B
27 "	11	21	31.5	27.5	MKS4B052706B	11	21	31.5	27.5	MKS4C052706B
33 "	13	24	31.5	27.5	MKS4B053306D	13	24	31.5	27.5	MKS4C053306D
39 "	15	26	31.5	27.5	MKS4B053906F	15	26	31.5	27.5	MKS4C053906F
47 "	15	26	31.5	27.5	MKS4B054706F	15	26	31.5	27.5	MKS4C054706F
						13	24	41.5	37.5	MKS4C054707C
56 "	17	29	31.5	27.5	MKS4B055606G	17	29	31.5	27.5	MKS4C055606G
						15	26	41.5	37.5	MKS4C055607D
68 "	20	39.5	31.5	27.5	MKS4B056806J	17	34.5	31.5	27.5	MKS4C056806I
						15	26	41.5	37.5	MKS4C056807D
82 "	17	34.5	31.5	27.5	MKS4B058206I	17	34.5	31.5	27.5	MKS4C058206I
						17	29	41.5	37.5	MKS4C058207E
100 µF	19	32	41.5	37.5	MKS4B061007F	20	39.5	31.5	27.5	MKS4C061006J
						19	32	41.5	37.5	MKS4C061007F
120 "	20	39.5	41.5	37.5	MKS4B061207G	20	39.5	41.5	37.5	MKS4C061207G
150 "	20	39.5	41.5	37.5	MKS4B061507G	20	39.5	41.5	37.5	MKS4C061507G
180 "	24	45.5	41.5	37.5	MKS4B061807H	24	45.5	41.5	37.5	MKS4C061807H
						28	38	41.5	37.5	MKS4C061807L
220 "	24	45.5	41.5	37.5	MKS4B062207H	31	46	41.5	37.5	MKS4C062207I
						25	45	57	52.5	MKS4C062209D
270 "	31	46	41.5	37.5	MKS4B062707L	31	46	41.5	37.5	MKS4C062707L
						25	45	57	52.5	MKS4C062709D
330 "	35	50	41.5	37.5	MKS4B063307J	35	50	41.5	37.5	MKS4C063307J
						30	45	57	52.5	MKS4C063309E
390 "	40	55	41.5	37.5	MKS4B063907K	40	55	41.5	37.5	MKS4C063907K
						30	45	57	52.5	MKS4C063909E
470 "	35	50	57	52.5	MKS4B064709F	35	50	57	52.5	MKS4C064709F
560 "	45	55	57	52.5	MKS4B065609H	45	55	57	52.5	MKS4C065609H
680 "	45	55	57	52.5	MKS4B066809H	45	65	57	52.5	MKS4C066809J

* AC voltages: $f = 50 \text{ Hz}$; $1.4 \times U_{\text{rms}} + U_{\text{DC}} \leq U_{\text{r}}$

** PCM = printed circuit module = pin spacing

Dims. in mm.

Rights reserved to amend design data without prior notification.

Continuation page 56



Continuation

General Data

Capacitance	100 VDC/63 VAC*					250 VDC/160 VAC*				
	W	H	L	PCM**	Part number	W	H	L	PCM**	Part number
0.01 μ F	2.5	7	10	7.5	MKS4D021002A	3	8.5	10	7.5	MKS4F021002B
	4	9	13	10	MKS4D021003C	4	9	13	10	MKS4F021003C
0.015 "	2.5	7	10	7.5	MKS4D021502A	3	8.5	10	7.5	MKS4F021502B
	4	9	13	10	MKS4D021503C	4	9	13	10	MKS4F021503C
0.022 "	2.5	7	10	7.5	MKS4D022202A	3	8.5	10	7.5	MKS4F022202B
	4	9	13	10	MKS4D022203C	4	9	13	10	MKS4F022203C
0.033 "	2.5	7	10	7.5	MKS4D023302A	3	8.5	10	7.5	MKS4F023302B
	4	9	13	10	MKS4D023303C	4	9	13	10	MKS4F023303C
0.047 "	2.5	7	10	7.5	MKS4D024702A	3	8.5	10	7.5	MKS4F024702B
	4	9	13	10	MKS4D024703C	4	9	13	10	MKS4F024703C
0.068 "	2.5	7	10	7.5	MKS4D026802A	4	9	10	7.5	MKS4F026802C
	4	9	13	10	MKS4D026803C	4	9	13	10	MKS4F026803C
0.1 μ F	2.5	7	10	7.5	MKS4D031002A	4	9	10	7.5	MKS4F031002C
	4	9	13	10	MKS4D031003C	4	9	13	10	MKS4F031003C
0.15 "	3	8.5	10	7.5	MKS4D031502B	5	10.5	10.3	7.5	MKS4F031502E
	4	9	13	10	MKS4D031503C	4	9	13	10	MKS4F031503C
0.22 "	3	8.5	10	7.5	MKS4D032202B	5	10.5	10.3	7.5	MKS4F032202E
	4	9	13	10	MKS4D032203C	5	11	13	10	MKS4F032203F
0.33 "	4	9	10	7.5	MKS4D033302C	5.7	12.5	10.3	7.5	MKS4F033302F
	4	9	13	10	MKS4D033303C	5	11	13	10	MKS4F033303F
0.47 "	4.5	9.5	10.3	7.5	MKS4D034702D	6	12	13	10	MKS4F034703G
	4	9	13	10	MKS4D034703C	6	12.5	18	15	MKS4F034704C
0.68 "	5	10.5	10.3	7.5	MKS4D036802E	7	14	18	15	MKS4F036804D
	4	9	13	10	MKS4D036803C					
1.0 μ F	5.7	12.5	10.3	7.5	MKS4D041002F	8	15	18	15	MKS4F041004F
	5	11	13	10	MKS4D041003F	6	15	26.5	22.5	MKS4F041005B
1.5 "	6	12	13	10	MKS4D041503G	9	16	18	15	MKS4F041504J
	7	14	18	15	MKS4D041504D	7	16.5	26.5	22.5	MKS4F041505D
2.2 "	8	15	18	15	MKS4D042204F	10.5	19	26.5	22.5	MKS4F042205G
	6	15	26.5	22.5	MKS4D042205B	9	19	31.5	27.5	MKS4F042206A
3.3 "	9	16	18	15	MKS4D043304J	11	21	26.5	22.5	MKS4F043305I
	7	16.5	26.5	22.5	MKS4D043305D	11	21	31.5	27.5	MKS4F043306B
4.7 "	10.5	19	26.5	22.5	MKS4D044705G	11	21	31.5	27.5	MKS4F044706B
	9	19	31.5	27.5	MKS4D044706A					
6.8 "	10.5	19	26.5	22.5	MKS4D046805G	13	24	31.5	27.5	MKS4F046806D
	11	21	31.5	27.5	MKS4D046806B					
10 μ F	9	19	31.5	27.5	MKS4D051006A	17	29	31.5	27.5	MKS4F051006G
						15	26	41.5	37.5	MKS4F051007D
15 "	11	21	31.5	27.5	MKS4D051506B	17	34.5	31.5	27.5	MKS4F051506I
						17	29	41.5	37.5	MKS4F051507E
18 "	11	21	31.5	27.5	MKS4D051806B	20	39.5	31.5	27.5	MKS4F051806J
						19	32	41.5	37.5	MKS4F051807F
22 "	13	24	31.5	27.5	MKS4D052206D	20	39.5	41.5	37.5	MKS4F052207G
	15	26	31.5	27.5	MKS4D052706F	20	39.5	41.5	37.5	MKS4F052707G
27 "	15	26	31.5	27.5	MKS4D053306F	24	45.5	41.5	37.5	MKS4F053307H
	13	24	41.5	37.5	MKS4D053307C					
33 "	17	29	31.5	27.5	MKS4D053906G	24	45.5	41.5	37.5	MKS4F053907H
	15	26	41.5	37.5	MKS4D053907D					
39 "	17	29	31.5	27.5	MKS4D054706I	31	46	41.5	37.5	MKS4F054707I
	17	29	41.5	37.5	MKS4D054707E					
47 "	20	39.5	31.5	27.5	MKS4D055606J	35	50	41.5	37.5	MKS4F055607J
	17	29	41.5	37.5	MKS4D055607E	25	45	57	52.5	MKS4F055609D
56 "	20	39.5	31.5	27.5	MKS4D056806J	35	50	41.5	37.5	MKS4F056807J
	19	32	41.5	37.5	MKS4D056807F	30	45	57	52.5	MKS4F056809E
68 "	20	39.5	41.5	37.5	MKS4D058207G	40	55	41.5	37.5	MKS4F058207K
						35	50	57	52.5	MKS4F058209F
100 μ F	20	39.5	41.5	37.5	MKS4D061007G	45	55	57	52.5	MKS4F061009H
	24	45.5	41.5	37.5	MKS4D061207H	45	55	57	52.5	MKS4F061209H
120 "	31	46	41.5	37.5	MKS4D061507I	45	65	57	52.5	MKS4F061509J
	31	46	41.5	37.5	MKS4D061807I					
150 "	25	45	57	52.5	MKS4D061809H					
	35	50	41.5	37.5	MKS4D062207J					
180 "	30	45	57	52.5	MKS4D062209E					
	40	55	41.5	37.5	MKS4D062707K					
220 "	35	50	57	52.5	MKS4D062709F					
	45	55	57	52.5	MKS4D063309H					
270 "	45	55	57	52.5	MKS4D063909H					
	45	65	57	52.5	MKS4D064709J					

* AC voltage: $f = 50 \text{ Hz}$; $1.4 \times U_{\text{rms}} + U_{\text{DC}} \leq U_{\text{r}}$
 **PCM = Printed circuit module = pin spacing
 Dims. in mm.

Rights reserved to amend design data without prior notification.

Continuation

General Data

Capacitance	400 VDC/200 VAC*					630 VDC/400 VAC*				
	W	H	L	PCM**	Part number	W	H	L	PCM**	Part number
0.01 µF	3	8.5	10	7.5	MKS4G021002B	3	8.5	10	7.5*	MKS4J021002B
	4	9	13	10	MKS4G021003C	4	9	13	10	MKS4J021003C
0.015 "	3	8.5	10	7.5	MKS4G021502B	4	9	10	7.5*	MKS4J021502C
	4	9	13	10	MKS4G021503C	4	9	13	10	MKS4J021503C
0.022 "	4	9	10	7.5	MKS4G022202C	4.5	9.5	10.3	7.5*	MKS4J022202D
	4	9	13	10	MKS4G022203C	4	9	13	10	MKS4J022203C
0.033 "	4	9	10	7.5	MKS4G023302C	5	10.5	10.3	7.5*	MKS4J023302E
	4	9	13	10	MKS4G023303C	5	11	13	10	MKS4J023303F
0.047 "	5	10.5	10.3	7.5	MKS4G024702E	5.7	12.5	10.3	7.5*	MKS4J024702F
	4	9	13	10	MKS4G024703C	6	12	13	10	MKS4J024703G
0.068 "	5	10.5	10.3	7.5	MKS4G026802E	6	12	13	10	MKS4J026803G
	4	9	13	10	MKS4G026803C	5	11	18	15	MKS4J026804B
0.1 µF	5	10.5	10.3	7.5	MKS4G031002E	6	12.5	18	15	MKS4J031004C
	5	11	13	10	MKS4G031003F	6	15	26.5	22.5	MKS4J031005B
0.15 "	5.7	12.5	10.3	7.5	MKS4G031502F	7	14	18	15	MKS4J031504D
	6	12	13	10	MKS4G031503G	6	15	26.5	22.5	MKS4J031505B
0.22 "	6	12	13	10	MKS4G032203G	8	15	18	15	MKS4J032204F
	6	12.5	18	15	MKS4G032204C	6	15	26.5	22.5	MKS4J032205B
0.33 "	8	15	18	15	MKS4G033304F	7	16.5	26.5	22.5	MKS4J033305D
						9	19	31.5	27.5	MKS4J033306A
0.47 "	8	15	18	15	MKS4G034704F	10.5	19	26.5	22.5	MKS4J034705G
	6	15	26.5	22.5	MKS4G034705B	9	19	31.5	27.5	MKS4J034706A
0.68 "	7	16.5	26.5	22.5	MKS4G036805D	11	21	26.5	22.5	MKS4J036805I
						11	21	31.5	27.5	MKS4J036806B
1.0 µF	10.5	19	26.5	22.5	MKS4G041005G	11	21	31.5	27.5	MKS4J041006B
	11	21	31.5	27.5	MKS4G041006B					
1.5 "	11	21	26.5	22.5	MKS4G041505I	15	26	31.5	27.5	MKS4J041506F
	11	21	31.5	27.5	MKS4G041506B					
2.2 "	11	21	31.5	27.5	MKS4G042206B	17	34.5	31.5	27.5	MKS4J042206I
						15	26	41.5	37.5	MKS4J042207D
3.3 "	13	24	31.5	27.5	MKS4G043306D	20	39.5	31.5	27.5	MKS4J043306J
						19	32	41.5	37.5	MKS4J043307F
4.7 "	17	29	31.5	27.5	MKS4G044706G	20	39.5	41.5	37.5	MKS4J044707G
6.8 "	17	34.5	31.5	27.5	MKS4G046806I	24	45.5	41.5	37.5	MKS4J046807H
	15	26	41.5	37.5	MKS4G046807D					
10 µF	19	32	41.5	37.5	MKS4G051007F	35	50	41.5	37.5	MKS4J051007J
15 "	20	39.5	41.5	37.5	MKS4G051507G	40	55	41.5	37.5	MKS4J051507K
18 "	31	46	41.5	37.5	MKS4G051807I	45	55	57	52.5	MKS4J051809H
22 "	31	46	41.5	37.5	MKS4G052207I	45	55	57	52.5	MKS4J052209H
27 "	35	50	41.4	37.5	MKS4G052707J					
33 "	35	50	41.5	37.5	MKS4G053307J					
39 "	35	50	57	52.5	MKS4G053909F					
47 "	35	50	57	52.5	MKS4G054709F					
56 "	45	65	57	52.5	MKS4G055609J					
68 "	45	65	57	52.5	MKS4G056809J					

* AC voltages: $f = 50 \text{ Hz}$; $1.4 \times U_{\text{rms}} + U_{\text{DC}} \leq U_{\text{r}}$

**PCM = printed circuit module = pin spacing

* Admissible AC voltage 250 VAC max.

Dims. in mm.

Part number completion:	
Version code:	2-pin = 00
	4-pin = D4
Tolerance:	20 % = M
	10 % = K
	5 % = J
Packing:	bulk = S
Pin length:	6-2 = SD
Taped version see page 157.	

Rights reserved to amend design data without prior notification.

Continuation page 58

Continuation

General Data

Capacitance	1000 VDC/400 VAC*					1500 VDC/400 VAC*				
	W	H	L	PCM**	Part number	W	H	L	PCM**	Part number
1000 pF	3	8.5	10	7.5	MKS4O111002B	4	9	13	10	MKS4S011003C
	4	9	13	10	MKS4O111003C					
1500 "	3	8.5	10	7.5	MKS4O111502B	4	9	13	10	MKS4S011503C
	4	9	13	10	MKS4O111503C					
2200 "	3	8.5	10	7.5	MKS4O112202B	4	9	13	10	MKS4S012203C
	4	9	13	10	MKS4O112203C					
3300 "	4	9	10	7.5	MKS4O113302C	4	9	13	10	MKS4S013303C
	4	9	13	10	MKS4O113303C					
4700 "	4	9	10	7.5	MKS4O114702C	4	9	13	10	MKS4S014703C
	4	9	13	10	MKS4O114703C	5	11	18	15	MKS4S014704B
6800 "	4.5	9.5	10.3	7.5	MKS4O116802D	5	11	13	10	MKS4S016803F
	4	9	13	10	MKS4O116803C	5	11	18	15	MKS4S016804B
0.01 µF	5	10.5	10.3	7.5	MKS4O121002E	6	12	13	10	MKS4S021003G
	5	11	13	10	MKS4O121003F	5	11	18	15	MKS4S021004B
0.015 "	5.7	12.5	10.3	7.5	MKS4O121502F	6	12.5	18	15	MKS4S021504C
	6	12	13	10	MKS4O121503G					
0.022 "	5	11	18	15	MKS4O122204B	7	14	18	15	MKS4S022204D
						6	15	26.5	22.5	MKS4S022205B
0.033 "	6	12.5	18	15	MKS4O123304C	8	15	18	15	MKS4S023304F
	6	15	26.5	22.5	MKS4O123305B	6	15	26.5	22.5	MKS4S023305B
0.047 "	7	14	18	15	MKS4O124704D	7	16.5	26.5	22.5	MKS4S024705D
	6	15	26.5	22.5	MKS4O124705B					
0.068 "	8	15	18	15	MKS4O126804F	8.5	18.5	26.5	22.5	MKS4S026805F
	6	15	26.5	22.5	MKS4O126805B					
0.1 µF	9	16	18	15	MKS4O131004J	10.5	19	26.5	22.5	MKS4S031005G
	7	16.5	26.5	22.5	MKS4O131005D	9	19	31.5	27.5	MKS4S031006A
0.15 "	8.5	18.5	26.5	22.5	MKS4O131505F	11	21	31.5	27.5	MKS4S031506B
0.22 "	10.5	19	26.5	22.5	MKS4O132205G	13	24	31.5	27.5	MKS4S032206D
0.33 "	11	21	26.5	22.5	MKS4O133305I	17	34.5	31.5	27.5	MKS4S033306I
	11	21	31.5	27.5	MKS4O133306B	17	29	41.5	37.5	MKS4S033307E
0.47 "	13	24	31.5	27.5	MKS4O134706D	20	39.5	31.5	27.5	MKS4S034706J
						17	29	41.5	37.5	MKS4S034707E
0.68 "	15	26	31.5	27.5	MKS4O136806F	20	39.5	41.5	37.5	MKS4S036807G
1.0 µF	17	29	31.5	27.5	MKS4O141006G	24	45.5	41.5	37.5	MKS4S041007H
	17	29	41.5	37.5	MKS4O141007E					
1.5 "	19	32	41.5	37.5	MKS4O141507F	31	46	41.5	37.5	MKS4S041507I
2.2 "	20	39.5	41.5	37.5	MKS4O142207G	35	50	41.5	37.5	MKS4S042207J
						35	50	57	52.5	MKS4S042209F
3.3 "	24	45.5	41.5	37.5	MKS4O143307H	45	55	57	52.5	MKS4S043309H
4.7 "	35	50	41.5	37.5	MKS4O144707J	45	65	57	52.5	MKS4S044709J
6.8 "	40	55	41.5	37.5	MKS4O146807K					
	35	50	57	52.5	MKS4O146809F					
10 µF	45	55	57	52.5	MKS4O151009H					

* AC voltages: $f = 50 \text{ Hz}$; $1.4 \times U_{\text{rms}} + \text{UDC} \leq U_r$

** PCM = printed circuit module = pin spacing

Dims. in mm.

Part number completion:

Version code:	2-pin	= 00
	4-pin	= D4
Tolerance:	20 %	= M
	10 %	= K
	5 %	= J
Packing:	bulk	= S
Pin length:	6-2	= SD
Taped version see page 157.		

Rights reserved to amend design data without prior notification.

Continuation page 59

Continuation

General Data

Capacitance	2000 VDC/400 VAC*				
	W	H	L	PCM**	Part number
1000 pF	4	9	13	10	MKS4U011003C
1500 "	4	9	13	10	MKS4U011503C
2200 "	5	11	13	10	MKS4U012203F
3300 "	6	12	13	10	MKS4U013303G
	5	11	18	15	MKS4U013304B
4700 "	5	11	18	15	MKS4U014704B
6800 "	6	12.5	18	15	MKS4U016804C
0.01 µF	7	14	18	15	MKS4U021004D
	6	15	26.5	22.5	MKS4U021005B
0.015 "	6	15	26.5	22.5	MKS4U021505B
0.022 "	7	16.5	26.5	22.5	MKS4U022205D
0.033 "	10.5	19	26.5	22.5	MKS4U023305G
0.047 "	11	21	26.5	22.5	MKS4U024705I
	11	21	31.5	27.5	MKS4U024706B
0.068 "	11	21	31.5	27.5	MKS4U026806B
0.1 µF	13	24	31.5	27.5	MKS4U031006D
0.15 "	17	29	31.5	27.5	MKS4U031506G
	13	24	41.5	37.5	MKS4U031507C
0.22 "	17	29	41.5	37.5	MKS4U032207E
0.33 "	20	39.5	41.5	37.5	MKS4U033307G
0.47 "	24	45.5	41.5	37.5	MKS4U034707H
0.68 "	31	46	41.5	37.5	MKS4U036807I
1.0 µF	40	55	41.5	37.5	MKS4U041007K
	25	45	57	52.5	MKS4U041009D
1.5 "	30	45	57	52.5	MKS4U041509E
2.2 "	45	55	57	52.5	MKS4U042209H
3.3 "	45	65	57	52.5	MKS4U043309J

* AC voltage: $f = 50 \text{ Hz}; 1.4 \times U_{\text{rms}} + U_{\text{DC}} \leq U_r$

** PCM = Printed circuit module = pin spacing

Dims. in mm.

Part number completion:	
Version code:	2-pin = 00
	4-pin = D4
Tolerance:	20 % = M
	10 % = K
	5 % = J
Packing:	bulk = S
Pin length:	6-2 = SD
Taped version see page 157.	

W	PCM	b	Ød	c
17	37.5	10	1.0	0.4
19	37.5	10	1.0	0.4
20	37.5	12.5	1.0	0.4
24	37.5	12.5	1.0	0.4
28	37.5	10	1.0	0.4
31	37.5	20	1.0	0.4
35	37.5	20	1.0	0.4
40	37.5	20	1.0	0.4
25	52.5	12.5	1.2	0.8
30	52.5	20	1.2	0.8
35	52.5	20	1.2	0.8
45	52.5	20	1.2	0.8

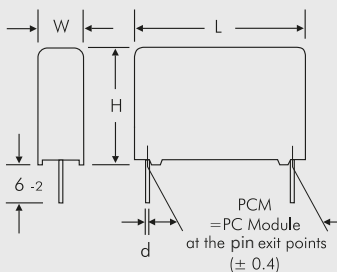

Ø d	PCM	W
0.5	7.5	≤ 3
0.6	7.5	≥ 4
0.6	10	
0.8	15 - 27.5	
1.0	37.5	

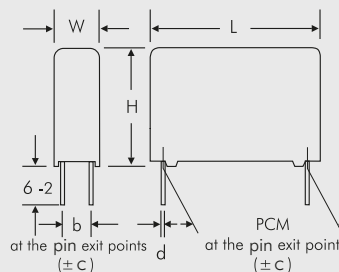

Rights reserved to amend design data without prior notification.

Permissible AC voltage in relation to frequency at 10° C internal temperature rise (general guide).

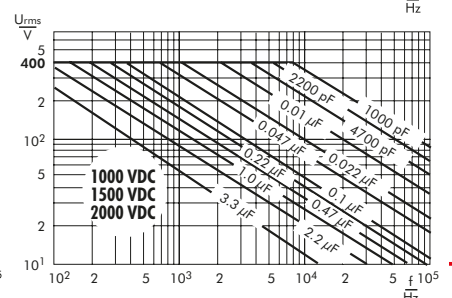
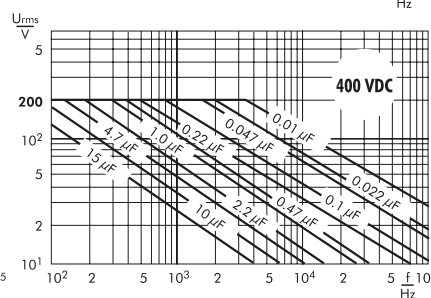
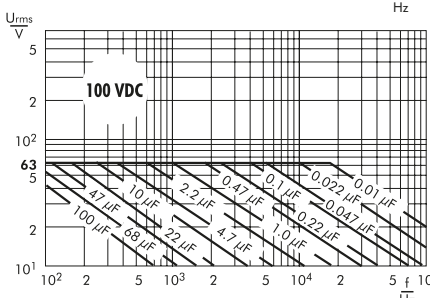
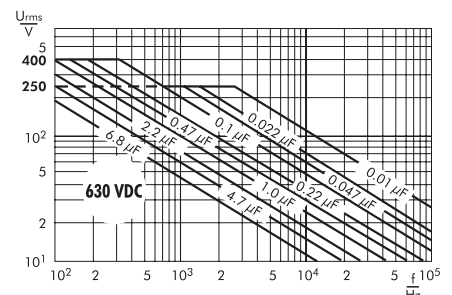
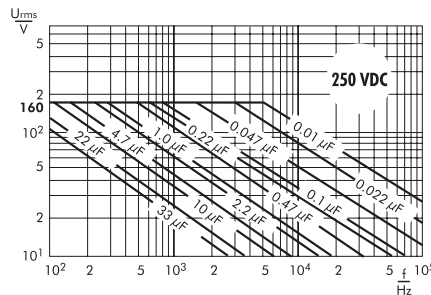
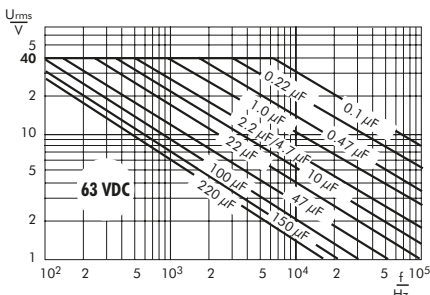

Continuation

Impedance change with frequency
(general guide).

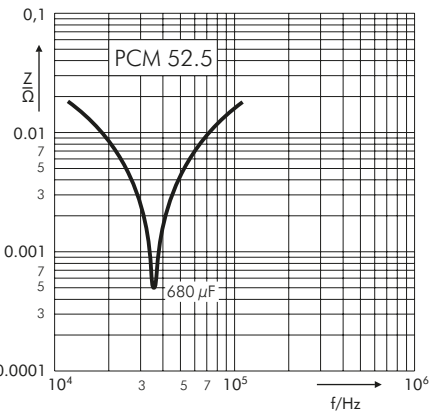
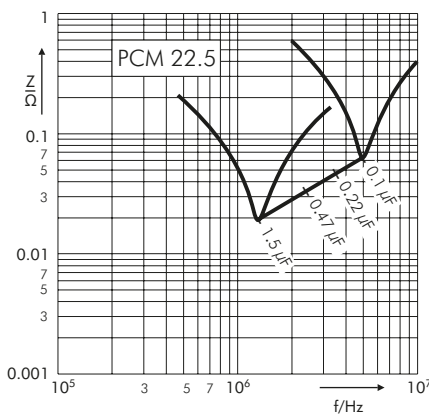
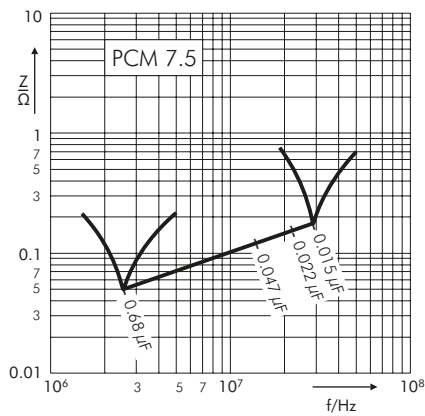
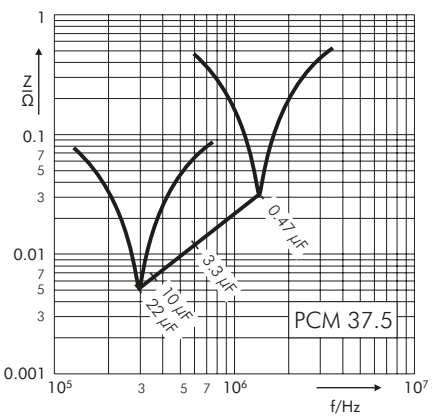
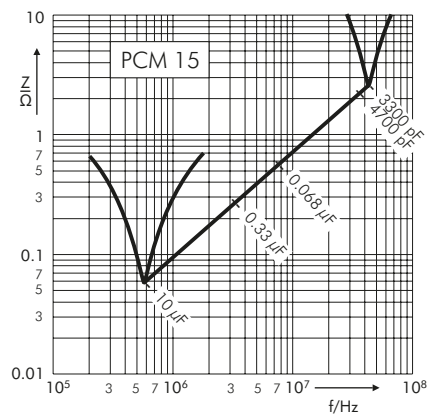
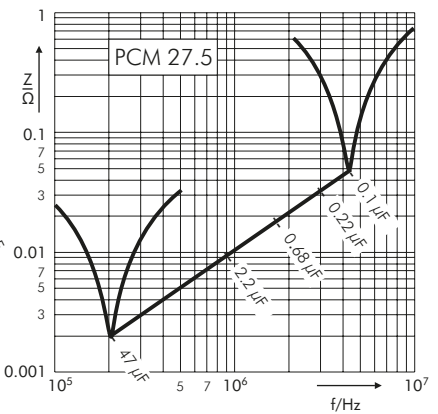
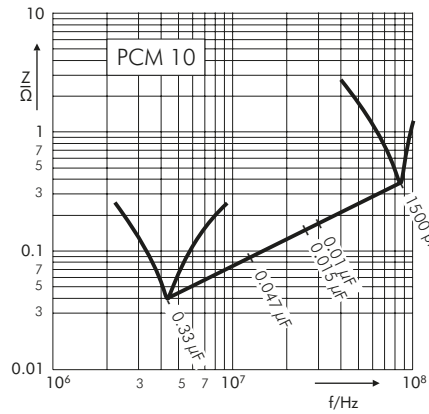

Metallized Polypropylene (PP) Capacitors
in PCM 7.5 mm to 37.5 mm. Capacitances from 0.01 µF to 68 µF.
Rated Voltages from 100 VDC to 1250 VDC.

Special Features

- High volume/capacitance ratio
- Self-healing
- Very low dissipation factor
- Negative capacitance change versus temperature
- Very low dielectric absorption
- AEC-Q200 qualified
- According to RoHS 2015/863/EU

Typical Applications

For high frequency applications e.g.

- Sample and hold
- Timing
- Oscillating circuits
- High frequency coupling and decoupling

Construction

Dielectric:

Polypropylene (PP) film

Capacitor electrodes:

Vacuum-deposited

Internal construction:

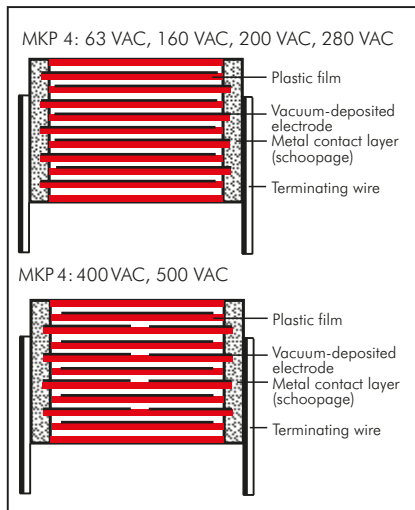

Encapsulation:

Solvent-resistant, flame-retardant plastic case with epoxy resin seal, UL 94 V-0

Terminations:

Tinned wire.

Marking:

Colour: Red. Marking: Black.

Electrical Data

Capacitance range:

0.01 µF to 68 µF

Rated voltages:

100VDC, 250VDC, 400VDC, 630VDC, 1000VDC, 1250VDC

Capacitance tolerances:

± 20%, ± 10%, ± 5%

Operating temperature range:

-55° C to +105° C

Climatic test category:

55/100/56 in accordance with IEC

Insulation resistance at +20° C:

$C \leq 0.33 \mu\text{F}: \geq 1 \times 10^5 \text{ M}\Omega$

$C > 0.33 \mu\text{F}: \geq 30000 \text{ sec (M}\Omega \times \mu\text{F)}$

Measuring voltage: 100 V/1 min.

Dissipation factors at +20° C: $\tan \delta$

at f	$C \leq 0.1 \mu\text{F}$	$0.1 \mu\text{F} < C \leq 1.0 \mu\text{F}$	$C > 1.0 \mu\text{F}$
1 kHz	$\leq 6 \times 10^{-4}$	$\leq 6 \times 10^{-4}$	$\leq 6 \times 10^{-4}$
10 kHz	$\leq 8 \times 10^{-4}$	$\leq 8 \times 10^{-4}$	-
100 kHz	$\leq 25 \times 10^{-4}$	-	-

Test specifications:

In accordance with IEC 60384-16

Test voltage: $1.6 U_r$, 2 sec.

Dielectric absorption:

0.05%

Voltage derating:

A voltage derating factor of 1.35 % per K must be applied from +85° C for DC voltages and from +75° C for AC voltages.

Reliability:

Operational life > 300000 hours

Failure rate < 2 fit ($0.5 \times U_r$ and 40° C).

Maximum pulse rise time:

Capacitance µF	max. pulse rise time V/µsec at $T_A < 40^\circ \text{C}$					
	100 VDC	250 VDC	400 VDC	630 VDC	1000 VDC	1250 VDC
0.01 ... 0.022	450	450	450	500	550	600
0.033 ... 0.068	250	250	300	350	400	450
0.1 ... 0.22	150	150	200	250	300	350
0.33 ... 0.68	100	100	150	200	200	250
1.0 ... 2.2	75	100	100	150	150	200
3.3 ... 4.7	60	100	100	120	140	160
6.8 ... 10	40	50	60	85	-	-
12 ... 68	20	20	40	50	-	-

Mechanical Tests

Pull test on pins:

$d \leq 0.8 \text{ } \varnothing$: 10 N in direction of pins

$d > 0.8 \text{ } \varnothing$: 20 N in direction of pins

according to IEC 60068-2-21

Vibration:

6 hours at 10...2000 Hz and 0.75 mm

displacement amplitude or 10 g in

accordance with IEC 60068-2-6

Low air density:

1kPa = 10 mbar in accordance with

IEC 60068-2-13

Bump test:

4000 bumps at 390 m/sec²

in accordance with IEC 60068-2-29

Packing

Available taped and reeled up to and including case size 15 x 26 x 31.5 / PCM 27.5 mm.

Detailed taping information and graphs at the end of the catalogue.

For further details and graphs please refer to Technical Information.

Continuation

General Data

Capacitance	100 VDC/63 VAC*					250 VDC/160 VAC*				
	W	H	L	PCM**	Part number	W	H	L	PCM**	Part number
0.01 µF	3	8.5	10	7.5	MKP4D021002B00	3	8.5	10	7.5	MKP4F021002B00
0.015 "	3	8.5	10	7.5	MKP4D021502B00	3	8.5	10	7.5	MKP4F021502B00
0.022 "	3	8.5	10	7.5	MKP4D022202B00	3	8.5	10	7.5	MKP4F022202B00
0.033 "	3	8.5	10	7.5	MKP4D023302B00	3	8.5	10	7.5	MKP4F023302B00
	4	9	13	10	MKP4D023303C00	4	9	13	10	MKP4F023303C00
0.047 "	4	9	10	7.5	MKP4D024702C00	4	9	10	7.5	MKP4F024702C00
	4	9	13	10	MKP4D024703C00	4	9	13	10	MKP4F024703C00
0.068 "	4	9	10	7.5	MKP4D026802C00	4	9	10	7.5	MKP4F026802C00
	4	9	13	10	MKP4D026803C00	4	9	13	10	MKP4F026803C00
0.1 µF	4.5	9.5	10.3	7.5	MKP4D031002D00	4.5	9.5	10.3	7.5	MKP4F031002D00
	4	9	13	10	MKP4D031003C00	4	9	13	10	MKP4F031003C00
0.15 "	5	10.5	10.3	7.5	MKP4D031502E00	5	10.5	10.3	7.5	MKP4F031502E00
	5	11	13	10	MKP4D031503F00	5	11	13	10	MKP4F031503F00
0.22 "	6	12	13	10	MKP4D032203G00	6	12	13	10	MKP4F032203G00
	5	11	18	15	MKP4D032204B00	5	11	18	15	MKP4F032204B00
0.33 "	6	12.5	18	15	MKP4D033304C00	6	12.5	18	15	MKP4F033304C00
0.47 "	7	14	18	15	MKP4D034704D00	7	14	18	15	MKP4F034704D00
0.68 "	8	15	18	15	MKP4D036804F00	8	15	18	15	MKP4F036804F00
	6	15	26.5	22.5	MKP4D036805B00	6	15	26.5	22.5	MKP4F036805B00
1.0 µF	7	16.5	26.5	22.5	MKP4D041005D00	7	16.5	26.5	22.5	MKP4F041005D00
					MKP4D041205G00	9	19	31.5	27.5	MKP4F041006A00
1.2 "	10.5	19	26.5	22.5	MKP4D041205G00	10.5	19	26.5	22.5	MKP4F041205G00
					MKP4D041505G00	9	19	31.5	27.5	MKP4F041206A00
1.5 "	10.5	19	26.5	22.5	MKP4D041505G00	10.5	19	26.5	22.5	MKP4F041505G00
					MKP4D041805I00	11	21	31.5	27.5	MKP4F041506B00
1.8 "	11	21	26.5	22.5	MKP4D041805I00	11	21	26.5	22.5	MKP4F041805I00
					MKP4D042205I00	11	21	31.5	27.5	MKP4F041806B00
2.2 "	11	21	26.5	22.5	MKP4D042205I00	11	21	26.5	22.5	MKP4F042205I00
	9	19	31.5	27.5	MKP4D042206A00	11	21	31.5	27.5	MKP4F042206B00
2.7 "	9	19	31.5	27.5	MKP4D042706A00	11	21	31.5	27.5	MKP4F042706B00
3.3 "	9	19	31.5	27.5	MKP4D043306A00	13	24	31.5	27.5	MKP4F043306D00
3.9 "	11	21	31.5	27.5	MKP4D043906B00	13	24	31.5	27.5	MKP4F043906D00
4.7 "	13	24	31.5	27.5	MKP4D044706D00	15	26	31.5	27.5	MKP4F044706F00
					MKP4D045606D00	13	24	41.5	37.5	MKP4F044707C00
5.6 "	13	24	31.5	27.5	MKP4D045606D00	17	29	31.5	27.5	MKP4F045606G00
					MKP4D046806F00	15	26	41.5	37.5	MKP4F045607D00
6.8 "	15	26	31.5	27.5	MKP4D046806F00	17	29	31.5	27.5	MKP4F046806G00
					MKP4D048206F00	15	26	41.5	37.5	MKP4F046807D00
8.2 "	15	26	31.5	27.5	MKP4D048206F00	17	34.5	31.5	27.5	MKP4F046806I00
						17	29	41.5	37.5	MKP4F046807E00
10 µF	17	29	31.5	27.5	MKP4D051006G00	20	39.5	31.5	27.5	MKP4F051006J00
	13	24	41.5	37.5	MKP4D051007C00	19	32	41.5	37.5	MKP4F051007F00
12 "	17	29	31.5	27.5	MKP4D051206G00	20	39.5	41.5	37.5	MKP4F051207G00
	15	26	41.5	37.5	MKP4D051207D00					
15 "	17	34.5	31.5	27.5	MKP4D051506I00	20	39.5	41.5	37.5	MKP4F051507G00
	17	29	41.5	37.5	MKP4D051507E00					
18 "	20	39.5	31.5	27.5	MKP4D051806J00	24	45.5	41.5	37.5	MKP4F051807H00
	19	32	41.5	37.5	MKP4D051807F00					
22 "	20	39.5	41.5	37.5	MKP4D052207G00	24	45.5	41.5	37.5	MKP4F052207H00
					MKP4D052707G00	28	38	41.5	37.5	MKP4F052207L00
27 "	20	39.5	41.5	37.5	MKP4D052707G00	31	46	41.5	37.5	MKP4F052707I00
33 "	28	38	41.5	37.5	MKP4D053307L00	35	50	41.5	37.5	MKP4F053307J00
	24	45.5	41.5	37.5	MKP4D053307H00					
39 "	31	46	41.5	37.5	MKP4D053907I00	40	55	41.5	37.5	MKP4F053907K00
47 "	35	50	41.5	37.5	MKP4D054707J00					
56 "	35	50	41.5	37.5	MKP4D055607J00					
68 "	40	55	41.5	37.5	MKP4D056807K00					

* AC voltage: $f \leq 400 \text{ Hz}$; $1.4 \times U_{\text{rms}} + \text{UDC} \leq U_r$

Dims. in mm.

** PCM = Printed circuit module = pin spacing

Rights reserved to amend design data without prior notification.

Continuation

General Data

Capacitance	400 VDC/220 VAC*					630 VDC/280 VAC*				
	W	H	L	PCM**	Part number	W	H	L	PCM**	Part number
0.01 µF	3	8.5	10	7.5	MKP4G021002B00_____	3	8.5	10	7.5	MKP4J021002B00_____
						4	9	13	10	MKP4J021003C00_____
0.015 "	4	9	10	7.5	MKP4G021502C00_____	4	9	10	7.5	MKP4J021502C00_____
	4	9	13	10	MKP4G021503C00_____	4	9	13	10	MKP4J021503C00_____
0.022 "	4.5	9.5	10.3	7.5	MKP4G022202D00_____	4.5	9.5	10.3	7.5	MKP4J022202D00_____
	4	9	13	10	MKP4G022203C00_____	4	9	13	10	MKP4J022203C00_____
0.033 "	5	10.5	10.3	7.5	MKP4G023302E00_____	5	10.5	10.3	7.5	MKP4J023302E00_____
	4	9	13	10	MKP4G023303C00_____	4	9	13	10	MKP4J023303C00_____
0.047 "	5	10.5	10.3	7.5	MKP4G024702E00_____	5.7	12.5	10.3	7.5	MKP4J024702F00_____
	5	11	13	10	MKP4G024703F00_____	5	11	13	10	MKP4J024703F00_____
0.068 "	5.7	12.5	10.3	7.5	MKP4G026802F00_____	6	12	13	10	MKP4J026803G00_____
	5	11	13	10	MKP4G026803F00_____	6	12.5	18	15	MKP4J026804C00_____
0.1 µF	6	12	13	10	MKP4G031003G00_____	7	14	18	15	MKP4J031004D00_____
	5	11	18	15	MKP4G031004B00_____					
0.15 "	6	12.5	18	15	MKP4G031504C00_____	8	15	18	15	MKP4J031504F00_____
						6	15	26.5	22.5	MKP4J031505B00_____
0.22 "	7	14	18	15	MKP4G032204D00_____	9	16	18	15	MKP4J032204J00_____
						7	16.5	26.5	22.5	MKP4J032205D00_____
0.33 "	8	15	18	15	MKP4G033304F00_____	8.5	18.5	26.5	22.5	MKP4J033305F00_____
	6	15	26.5	22.5	MKP4G033305B00_____					
0.47 "	7	16.5	26.5	22.5	MKP4G034705D00_____	10.5	19	26.5	22.5	MKP4J034705G00_____
						11	21	31.5	27.5	MKP4J034706B00_____
0.68 "	8.5	18.5	26.5	22.5	MKP4G036805F00_____	11	21	31.5	27.5	MKP4J036806B00_____
1.0 µF	11	21	26.5	22.5	MKP4G041005I00_____	13	24	31.5	27.5	MKP4J041006D00_____
	11	21	31.5	27.5	MKP4G041006B00_____					
1.2 "	11	21	31.5	27.5	MKP4G041206B00_____	15	26	31.5	27.5	MKP4J041206F00_____
1.5 "	11	21	31.5	27.5	MKP4G041506B00_____	15	26	31.5	27.5	MKP4J041506F00_____
						13	24	41.5	37.5	MKP4J041507C00_____
1.8 "	13	24	31.5	27.5	MKP4G041806D00_____	17	29	31.5	27.5	MKP4J041806G00_____
						15	26	41.5	37.5	MKP4J041807D00_____
2.2 "	15	26	31.5	27.5	MKP4G042206F00_____	17	34.5	31.5	27.5	MKP4J042206I00_____
	13	24	41.5	37.5	MKP4G042207C00_____	17	29	41.5	37.5	MKP4J042207E00_____
2.7 "	17	29	31.5	27.5	MKP4G042706G00_____	17	29	41.5	37.5	MKP4J042707E00_____
3.3 "	17	29	31.5	27.5	MKP4G043306G00_____	20	39.5	31.5	27.5	MKP4J043306J00_____
						15	26	41.5	37.5	MKP4J043307F00_____
3.9 "	20	39.5	31.5	27.5	MKP4G043906J00_____	20	39.5	41.5	37.5	MKP4J043907G00_____
4.7 "	20	39.5	31.5	27.5	MKP4G044706J00_____	20	39.5	41.5	37.5	MKP4J044707G00_____
5.6 "	20	39.5	41.5	37.5	MKP4G045607G00_____	24	45.5	41.5	37.5	MKP4J045607H00_____
						28	38	41.5	37.5	MKP4J045607L00_____
6.8 "	20	39.5	41.5	37.5	MKP4G046807G00_____	24	45.5	41.5	37.5	MKP4J046807H00_____
						28	38	41.5	37.5	MKP4J046807L00_____
8.2 "	24	45.5	41.5	37.5	MKP4G048207H00_____	31	46	41.5	37.5	MKP4J048207I00_____
10 µF	24	45.5	41.5	37.5	MKP4G051007H00_____	35	50	41.5	37.5	MKP4J051007J00_____
	28	38	41.5	37.5	MKP4G051007L00_____					
12 "	31	46	41.5	37.5	MKP4G051207I00_____	40	55	41.5	37.5	MKP4J051207K00_____
15 "	31	46	41.5	37.5	MKP4G051507I00_____					
18 "	35	50	41.5	37.5	MKP4G051807J00_____					
22 "	40	55	41.5	37.5	MKP4G052207K00_____					

* AC voltages: $f \leq 400 \text{ Hz}$; $1.4 \times U_{\text{rms}} + U_{\text{DC}} \leq U_{\text{r}}$

** PCM = Printed circuit module = pin spacing

Dims. in mm.

Rights reserved to amend design data without prior notification.

Continuation page 64

Continuation

General Data

Capacitance	1000 VDC/400 VAC*					1250 VDC/500 VAC*				
	W	H	L	PCM**	Part number	W	H	L	PCM**	Part number
0.01 µF	5.7	12.5	10.3	7.5	MKP4O121002F00	5	11	18	15	MKP4R021004B00
	5	11	13	10	MKP4O121003F00					
0.015 "	5	11	13	10	MKP4O121503F00	6	12.5	18	15	MKP4R021504C00
	5	11	18	15	MKP4O121504B00					
0.022 "	5	11	18	15	MKP4O122204B00	7	14	18	15	MKP4R022204D00
0.033 "	6	12.5	18	15	MKP4O123304C00	8	15	18	15	MKP4R023304F00
0.047 "	7	14	18	15	MKP4O124704D00	6	15	26.5	22.5	MKP4R024705B00
0.068 "	8	15	18	15	MKP4O126804F00	8.5	18.5	26.5	22.5	MKP4R026805F00
	6	15	26.5	22.5	MKP4O126805B00					
0.1 µF	9	16	18	15	MKP4O131004J00	10.5	19	26.5	22.5	MKP4R031005G00
	7	16.5	26.5	22.5	MKP4O131005D00					
0.15 "	8.5	18.5	26.5	22.5	MKP4O131505F00	11	21	31.5	27.5	MKP4R031506B00
0.22 "	11	21	26.5	22.5	MKP4O132205I00	13	24	31.5	27.5	MKP4R032206D00
	11	21	31.5	27.5	MKP4O132206B00					
0.33 "	11	21	31.5	27.5	MKP4O133306B00	15	26	31.5	27.5	MKP4R033306F00
0.47 "	13	24	31.5	27.5	MKP4O134706D00	17	29	31.5	27.5	MKP4R034706G00
0.68 "	17	29	31.5	27.5	MKP4O136806G00	20	39.5	31.5	27.5	MKP4R036806J00
	15	26	41.5	37.5	MKP4O136807D00					
1.0 µF	20	39.5	31.5	27.5	MKP4O141006J00	20	39.5	41.5	37.5	MKP4R041007G00
	17	29	41.5	37.5	MKP4O141007E00					
1.2 "	19	32	41.5	37.5	MKP4O141207F00	20	39.5	41.5	37.5	MKP4R041207G00
1.5 "	20	39.5	41.5	37.5	MKP4O141507G00	24	45.5	41.5	37.5	MKP4R041507H00
1.8 "	20	39.5	41.5	37.5	MKP4O141807G00	24	45.5	41.5	37.5	MKP4R041807H00
2.2 "	24	45.5	41.5	37.5	MKP4O142207H00	31	46	41.5	37.5	MKP4R042207I00
	28	38	41.5	37.5	MKP4O142207L00					
2.7 "	31	46	41.5	37.5	MKP4O142707I00	35	50	41.5	37.5	MKP4R042707J00
3.3 "	31	46	41.5	37.5	MKP4O143307I00	40	55	41.5	37.5	MKP4R043307K00
3.9 "	35	50	41.5	37.5	MKP4O143907J00					
4.7 "	35	50	41.5	37.5	MKP4O144707J00					

* AC voltages: $f \leq 400 \text{ Hz}$; $1.4 \times U_{\text{rms}} + \text{UDC} \leq U_r$

** PCM = Printed circuit module = pin spacing

Dims. in mm.

Part number completion:	
Version code:	2-pin = 00
	4-pin = D4
Tolerance:	20 % = M
	10 % = K
	5 % = J
Packing:	bulk = S
Pin length:	6-2 = SD
Taped version see page 157.	

2-pin version

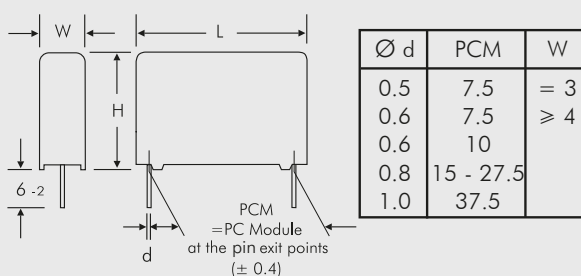

4-pin version

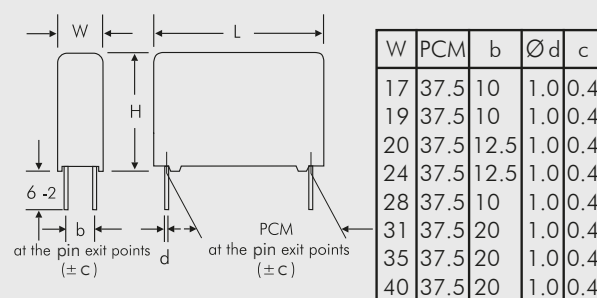

Rights reserved to amend design data without prior notification.

Continuation

Impedance change with frequency
(general guide).

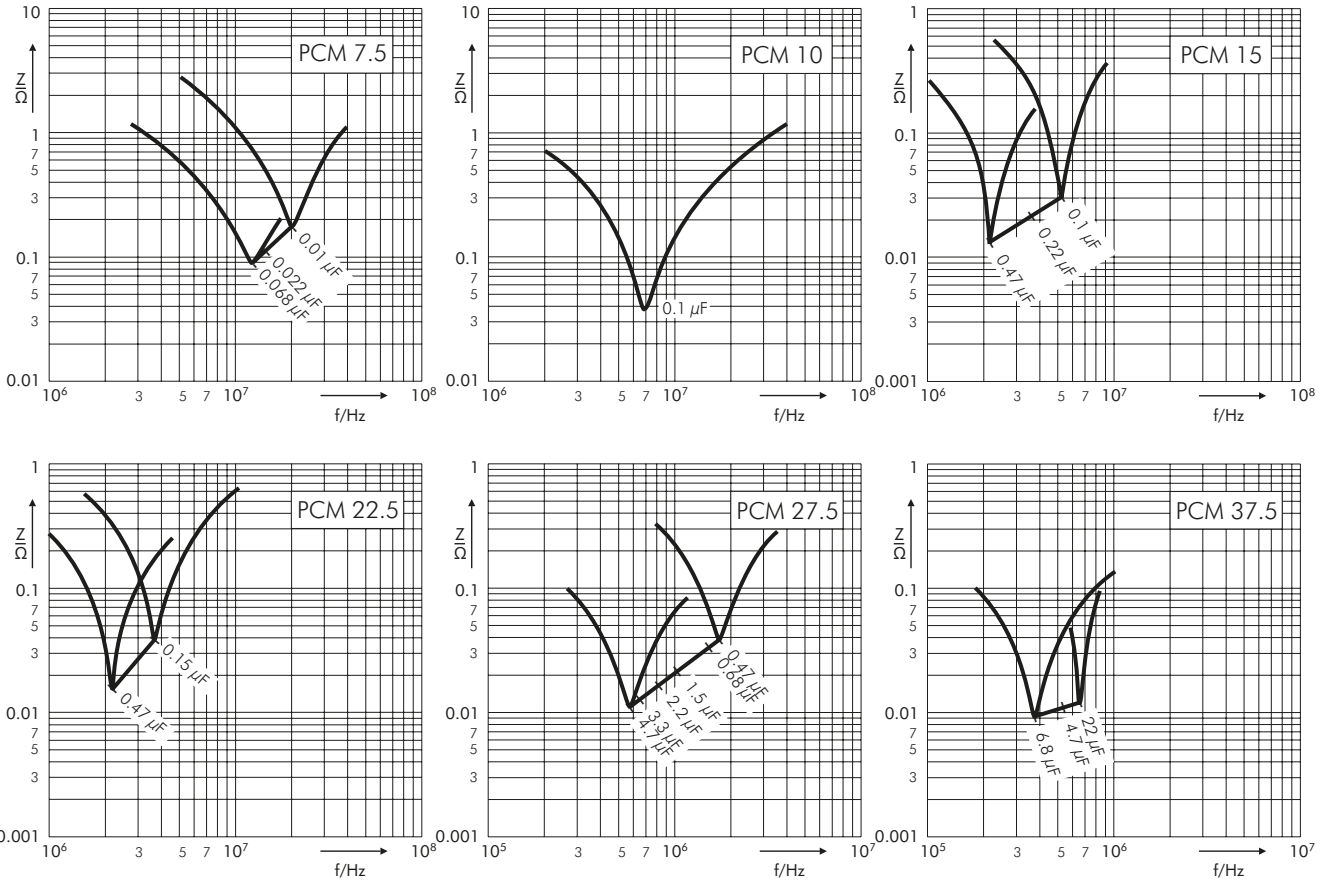

Permissible AC voltage
in relation to frequency
at 10° C internal temperature rise
(general guide).

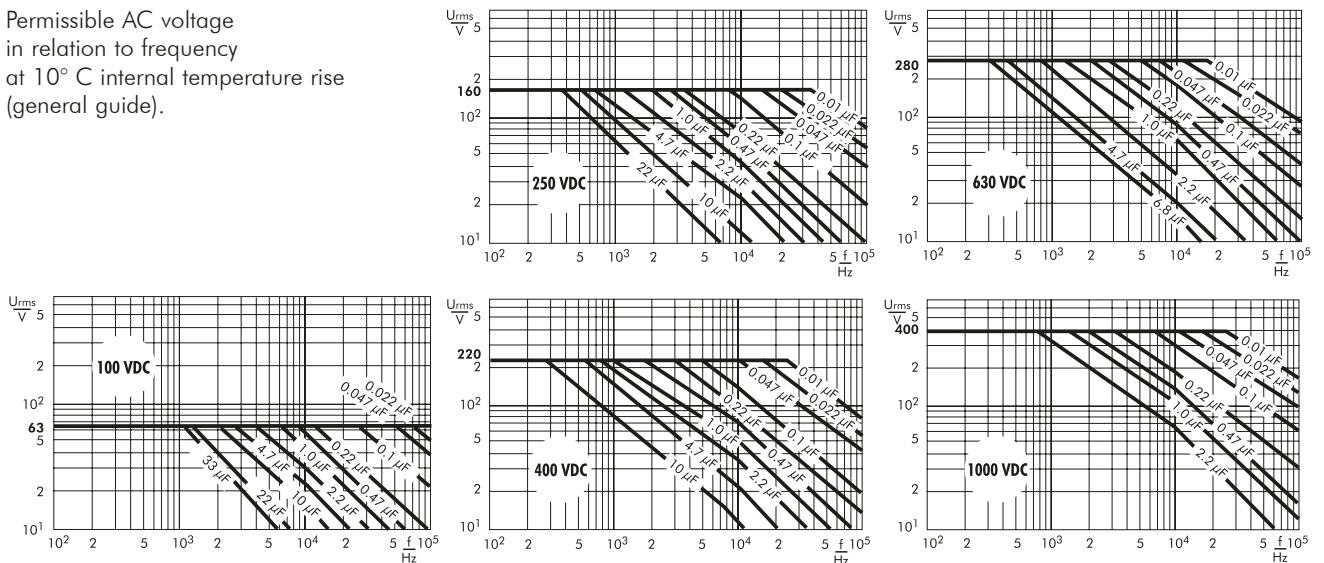

WIMA Capacitors for Good Contact at High Pulse Ratings



- WIMA MKP 10
- WIMA FKP 4
- WIMA FKP 1

An important construction criterion in the manufacture of reliable, self-healing capacitors for pulse applications is the current-carrying capacity of the contacts, i.e. the connection between the terminating wires and the electrodes.

The construction principle of the WIMA MKP 10 series consists of a non-metallized dielectric film and an carrier film metallized on both sides acting as electrode. Due to the metallization on both sides, the electrical conductivity is considerably improved and the contact surface between the electrodes and the schoopage layer is doubled. This results in better contact and allows high current and pulse loading capability. The properties of metallized capacitors such as excellent self-healing and high

capacitances remain unchanged.

The WIMA FKP 4 is a range of self-healing film/foil Polypropylene capacitors made with a single metallized plastic film and metal foil electrodes in series connection. This construction features a high volume capacitance and at the same time high pulse loading capability.

The WIMA FKP 1 series was developed to withstand extremely high pulse loads. It has an internal series connection, the metal foil electrodes being combined with a floating electrode metallized on both sides. The metal foil electrodes are safely contacted on both sides of the end surfaces. At the same time the capacitor is fully self-healing due to the floating electrode metallized on both sides. As regards pulse loading capability, WIMA FKP 1 represents the high-end of capacitor technology.

WIMA pulse capacitors are suitable for high pulse and high frequency applications in e.g. switch mode power supplies, TV and monitor sets, lighting industry, audio/video equipment, convertes in drives and power electronics or in electronic ballasts. They are available with capacitances from 100 pF through 47 µF and with voltage ratings from 100 VDC through 6000 VDC.

WIMA pulse capacitors are produced with the proven box technology using solvent-resistant, flame-retardant plastic cases according to UL 94 V-0. They are environmentally compatible with the RoHS 2015/863/EU regulations.



Polypropylene (PP) Capacitors for Pulse Applications with Double-Sided Metallized Electrodes in PCM 7.5 mm to 52.5 mm. Capacitances from 1000 pF to 47 µF. Rated Voltages from 100 VDC to 3000 VDC.

Special Features

- Pulse duty construction
- Self-healing
- Very low dissipation factor
- Negative capacitance change versus temperature
- AEC-Q200 qualified
- According to RoHS 2015/863/EU

Typical Applications

For pulse applications e.g.

- Switch mode power supplies
- TV and monitor sets
- Lighting
- Audio/video equipment

Construction

Dielectric: Polypropylene (PP) film

Capacitor electrodes:

Double-sided metallized plastic film

Internal construction:

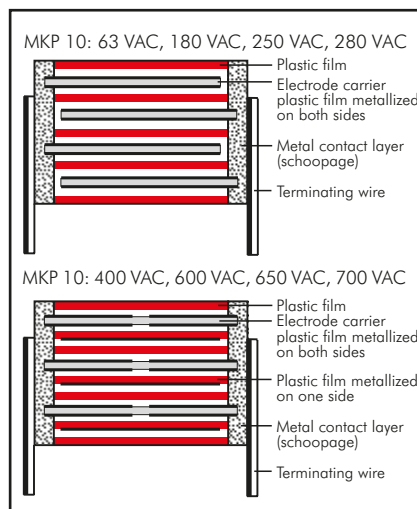

Encapsulation:

Solvent-resistant, flame-retardant plastic case with epoxy resin seal, UL 94 V-0

Terminations: Tinned wire.

Marking: Colour: Red.

Marking: Black.

Electrical Data

Capacitance range:

1000 pF to 47 µF

Rated voltages: 100VDC, 250VDC, 400VDC, 630VDC, 850VDC, 1000VDC, 1600VDC, 2000VDC, 2500VDC, 3000 VDC

Capacitance tolerances:

±20%, ±10%, ±5%

Operating temperature range:

-55° C to +105° C

Insulation resistance at +20° C:

$C \leq 0.33 \mu\text{F}: \geq 1 \times 10^5 \text{ M}\Omega$

$C > 0.33 \mu\text{F}: \geq 30000 \text{ sec} (\text{M}\Omega \times \mu\text{F})$

Measuring voltage: 100 V/1 min.

Test voltage: 2 sec.

L	≤ 2000VDC	2500VDC	≥ 3000VDC
< 41.5	1.6 U _r	1.4 U _r	1.2 U _r
41.5	1.4 U _r	1.4 U _r	1.2 U _r
57	1.2 U _r	1.2 U _r	1.2 U _r

Climatic test category:

55/100/56 in accordance with IEC

Dielectric absorption: 0.05 %

Voltage derating:

A voltage derating factor of 1.35 % per K must be applied from +85° C for DC voltages and from +75° C for AC voltages.

Reliability:

Operational life > 300 000 hours

Failure rate < 1 fit (0.5 x U_r and 40° C)

Specific dissipation:

Box size* WxHxL in mm	Specific dissipation in Watts per K above the ambient temperature
35 x 50 x 57	0.132
45 x 55 x 57	0.164
45 x 65 x 57	0.184

* other box sizes see page 11.

Dissipation factors at + 20° C: tan δ

at f	C ≤ 0.1 µF	0.1 µF < C ≤ 1.0 µF	C > 1.0 µF
1 kHz	≤ 6 x 10 ⁻⁴	≤ 6 x 10 ⁻⁴	≤ 6 x 10 ⁻⁴
10 kHz	≤ 6 x 10 ⁻⁴	≤ 6 x 10 ⁻⁴	-
100 kHz	≤ 15 x 10 ⁻⁴	-	-

Maximum pulse rise time:

Capacitance pF/µF	max. pulse rise time V/µsec at T _A < 40° C									
	100VDC	250VDC	400VDC	630VDC	850VDC	1000VDC	1600VDC	2000VDC	2500VDC	3000VDC
1000 ... 2200	1250	2300	2300	2300	3500	3500	7000	11500	11500	-
3300 ... 6800	1150	1500	1500	1500	3500	3500	7000	11500	11500	-
0.01 ... 0.022	900	1400	1500	1500	2700	2700	3800	4400	11500	-
0.033 ... 0.068	500	1000	1150	1400	2700	2700	2700	2700	2700	2700
0.1 ... 0.22	250	650	650	1150	1800	1800	1800	1800	1800	1800
0.33 ... 0.68	130	390	500	900	1150	1150	1150	1150	1150	1150
1.0 ... 2.2	90	250	250	500	500	500	650	650	650	500
3.3 ... 4.7	65	100	130	190	230	230	330	-	-	-
6.8 ... 15	45	65	90	160	-	-	-	-	-	-
22 ... 47	30	45	45	-	-	-	-	-	-	-

Mechanical Tests

Pull test on pins:

d ≤ 0.8 Ø: 10 N in direction of pins

d > 0.8 Ø: 20 N in direction of pins

according to IEC 60068-2-21

Vibration:

6 hours at 10 ... 2000 Hz

and 0.75 mm displacement amplitude or

10 g in accordance with IEC 60068-2-6

Low air density:

1kPa = 10 mbar in accordance with IEC 60068-2-13

Bump test:

4000 bumps at 390 m/sec² in accordance with IEC 60068-2-29

Packing

Available taped and reeled up to and including case size 15 x 26 x 31.5 / PCM 27.5 mm.

Detailed taping information and graphs at the end of the catalogue.

For further details and graphs please refer to Technical Information.

Continuation

General Data

Capacitance	100 VDC/63 VAC					250 VDC/180 VAC				
	W	H	L	PCM**	Part number	W	H	L	PCM**	Part number
0.01 µF	4	9	10	7.5	MKP1D021002C	4	9	10	7.5	MKP1F021002C
0.015 "	4	9	10	7.5	MKP1D021502C	4	9	10	7.5	MKP1F021502C
0.022 "	4	9	10	7.5	MKP1D022202C	4	9	10	7.5	MKP1F022202C
0.033 "	5	10.5	10.3	7.5	MKP1D023302E	5	10.5	10.3	7.5	MKP1F023302E
	4	9	13	10	MKP1D023303C	4	9	13	10	MKP1F023303C
0.047 "	5	10.5	10.3	7.5	MKP1D024702E	5	10.5	10.3	7.5	MKP1F024702E
	4	9	13	10	MKP1D024703C	4	9	13	10	MKP1F024703C
0.068 "	5	11	13	10	MKP1D026803F	5	11	13	10	MKP1F026803F
	5	11	18	15	MKP1F026804B					
0.1 µF	6	12	13	10	MKP1D031003G	6	12	13	10	MKP1F031003G
0.12 "	6	12.5	18	15	MKP1D031204C	6	12.5	18	15	MKP1F031204C
0.15 "	6	12.5	18	15	MKP1D031504C	6	12.5	18	15	MKP1F031504C
0.18 "	7	14	18	15	MKP1D031804D	7	14	18	15	MKP1F031804D
0.22 "	7	14	18	15	MKP1D032204D	7	14	18	15	MKP1F032204D
0.27 "	8	15	18	15	MKP1D032704F	8	15	18	15	MKP1F032704F
0.33 "	8	15	18	15	MKP1D033304F	8	15	18	15	MKP1F033304F
0.39 "	9	16	18	15	MKP1D033904J	9	16	18	15	MKP1F033904J
0.47 "	9	16	18	15	MKP1D034704J	9	16	18	15	MKP1F034704J
	7	16.5	26.5	22.5	MKP1D034705D	7	16.5	26.5	22.5	MKP1F034705D
0.56 "	8.5	18.5	26.5	22.5	MKP1D035605F	8.5	18.5	26.5	22.5	MKP1F035605F
0.68 "	8.5	18.5	26.5	22.5	MKP1D036805F	8.5	18.5	26.5	22.5	MKP1F036805F
						9	19	31.5	27.5	MKP1F036806A
0.82 "	10.5	19	26.5	22.5	MKP1D038205G	11	21	26.5	22.5	MKP1F038205I
1.0 µF	10.5	19	26.5	22.5	MKP1D041005G	11	21	26.5	22.5	MKP1F041005I
1.2 "	11	21	31.5	27.5	MKP1D041206B	11	21	31.5	27.5	MKP1F041006B
1.5 "	11	21	31.5	27.5	MKP1D041506B	13	24	31.5	27.5	MKP1F041206D
1.8 "	13	24	31.5	27.5	MKP1D041806D	13	24	31.5	27.5	MKP1F041506D
2.2 "	13	24	31.5	27.5	MKP1D042206D	15	26	31.5	27.5	MKP1F041806F
						15	26	31.5	27.5	MKP1F042206F
2.7 "	17	29	31.5	27.5	MKP1D042706G	13	24	41.5	37.5	MKP1F042207C
3.3 "	17	29	31.5	27.5	MKP1D043306G	17	34.5	31.5	27.5	MKP1F042706I
						17	34.5	31.5	27.5	MKP1F043306I
3.9 "	20	39.5	31.5	27.5	MKP1D043906J	17	29	41.5	37.5	MKP1F043307E
4.7 "	20	39.5	31.5	27.5	MKP1D044706J	20	39.5	31.5	27.5	MKP1F043906J
	17	29	41.5	37.5	MKP1D044707E	20	39.5	31.5	27.5	MKP1F044706J
5.6 "	19	32	41.5	37.5	MKP1D045607F	19	32	41.5	37.5	MKP1F044707F
6.8 "	19	32	41.5	37.5	MKP1D046807F	20	39.5	41.5	37.5	MKP1F045607G
8.2 "	20	39.5	41.5	37.5	MKP1D048207G	20	39.5	41.5	37.5	MKP1F046807G
						24	45.5	41.5	37.5	MKP1F048207H

* AC voltage: $f \leq 1000 \text{ Hz}$; $1.4 \times U_{\text{rms}} + U_{\text{DC}} \leq U_r$

** PCM = Printed circuit module = pin spacing

Dims. in mm.

Ionisation inception level in isolated cases may be lower than admissible rated AC voltage.

Part number completion:	
Version code:	2-pin = 00
	4-pin = D4
Tolerance:	20 % = M
	10 % = K
	5 % = J
Packing:	bulk = S
Pin length:	6-2 = SD
Taped version see page 157.	

Rights reserved to amend design data without prior notification.

Continuation

General Data

Capacitance	100 VDC/63 VAC*					250 VDC/180 VAC*				
	W	H	L	PCM**	Part number	W	H	L	PCM**	Part number
10 μ F	20	39.5	41.5	37.5	MKP1D051007G	24	45.5	41.5	37.5	MKP1F051007H
						28	38	41.5	37.5	MKP1F051007L
12 "	24	45.5	41.5	37.5	MKP1D051207H	35	50	41.5	37.5	MKP1F051207J
15 "	24	45.5	41.5	37.5	MKP1D051507H	35	50	41.5	37.5	MKP1F051507J
						35	50	57	52.5	MKP1F051509F
18 "	35	50	41.5	37.5	MKP1D051807J	35	50	57	52.5	MKP1F051809F
22 "	35	50	41.5	37.5	MKP1D052207J	35	50	57	52.5	MKP1F052209F
27 "	40	55	41.5	37.5	MKP1D052707K	45	65	57	52.5	MKP1F052709J
33 "	40	55	41.5	37.5	MKP1D053307K	45	65	57	52.5	MKP1F053309J
39 "	35	50	57	52.5	MKP1D053309F					
	45	65	57	52.5	MKP1D053909J					
47 "	45	65	57	52.5	MKP1D054709J					

Capacitance	400 VDC/250 VAC*					630 VDC/400 VAC*				
	W	H	L	PCM**	Part number	W	H	L	PCM**	Part number
1000 pF	4	9	10	7.5	MKP1G011002C	4	9	10	7.5*	MKP1J011002C
1200 "	4	9	10	7.5	MKP1G011202C	4	9	10	7.5*	MKP1J011202C
1500 "	4	9	10	7.5	MKP1G011502C	4	9	10	7.5*	MKP1J011502C
1800 "	4	9	10	7.5	MKP1G011802C	4	9	10	7.5*	MKP1J011802C
2200 "	4	9	10	7.5	MKP1G012202C	4	9	10	7.5*	MKP1J012202C
2700 "	4	9	10	7.5	MKP1G012702C	4	9	10	7.5*	MKP1J012702C
3300 "	4	9	10	7.5	MKP1G013302C	4	9	10	7.5*	MKP1J013302C
3900 "	4	9	10	7.5	MKP1G013902C	4	9	10	7.5*	MKP1J013902C
4700 "	4	9	10	7.5	MKP1G014702C	4	9	10	7.5*	MKP1J014702C
5600 "	4	9	10	7.5	MKP1G015602C	4	9	10	7.5*	MKP1J015602C
6800 "	4	9	10	7.5	MKP1G016802C	4	9	10	7.5*	MKP1J016802C
						4	9	13	10	MKP1J016803C
8200 "	4	9	10	7.5	MKP1G018202C	5	10.5	10.3	7.5*	MKP1J018202E
0.01 μ F	4	9	10	7.5	MKP1G021002C	5	10.5	10.3	7.5*	MKP1J021002E
	4	9	13	10	MKP1G021003C	4	9	13	10	MKP1J021003C
0.012 "	5	10.5	10.3	7.5	MKP1G021202E	5	11	13	10	MKP1J021203F
0.015 "	5	10.5	10.3	7.5	MKP1G021502E	5	11	13	10	MKP1J021503F
	4	9	13	10	MKP1G021503C	5	11	18	15	MKP1J021504B
0.018 "	5	10.5	10.3	7.5	MKP1G021802E	5	11	13	10	MKP1J021803F
0.022 "	5	10.5	10.3	7.5	MKP1G022202E	5	11	13	10	MKP1J022203F
	4	9	13	10	MKP1G022203C	5	11	18	15	MKP1J022204B
0.027 "	5.7	12.5	10.3	7.5	MKP1G022702F	6	12	13	10	MKP1J022703G
0.033 "	5.7	12.5	10.3	7.5	MKP1G023302F	6	12	13	10	MKP1J023303G
	5	11	13	10	MKP1G023303F	5	11	18	15	MKP1J023304B
0.039 "	6	12	13	10	MKP1G023903G	6	12.5	18	15	MKP1J023904C
0.047 "	6	12	13	10	MKP1G024703G	6	12.5	18	15	MKP1J024704C
	5	11	18	15	MKP1G024704B	6	15	26.5	22.5	MKP1J024705B
0.056 "	6	12.5	18	15	MKP1G025604C	7	14	18	15	MKP1J025604D
0.068 "	6	12.5	18	15	MKP1G026804C	7	14	18	15	MKP1J026804D
	6	15	26.5	22.5	MKP1G026805B	6	15	26.5	22.5	MKP1J026805B
0.082 "	7	14	18	15	MKP1G028204D	9	16	18	15	MKP1J028204J

* AC voltage: $f \leq 1000$ Hz; $1.4 \times U_{rms} + UDC \leq U_r$

** PCM = Printed circuit module = pin spacing

* Admissible AC voltage 280 VAC.

Dims. in mm.

Ionisation inception level in isolated cases may be lower than admissible rated AC voltage.

Part number completion:

Version code: 2-pin = 00
 4-pin = D4
 Tolerance: 20 % = M
 10 % = K
 5 % = J
 Packing: bulk = S
 Pin length: 6-2 = SD

Taped version see page 157.

Rights reserved to amend design data without prior notification.

Continuation

General Data

Capacitance	400 VDC/250 VAC*					630 VDC/400 VAC*				
	W	H	L	PCM**	Part number	W	H	L	PCM**	Part number
0.1 μ F	7	14	18	15	MKP1G031004D	9	16	18	15	MKP1J031004J
	6	15	26.5	22.5	MKP1G031005B	7	16.5	26.5	22.5	MKP1J031005D
0.12 "	8	15	18	15	MKP1G031204F	8.5	18.5	26.5	22.5	MKP1J031205F
0.15 "	8	15	18	15	MKP1G031504F	8.5	18.5	26.5	22.5	MKP1J031505F
	6	15	26.5	22.5	MKP1G031505B	9	19	31.5	27.5	MKP1J031506A
0.18 "	9	16	18	15	MKP1G031804J	8.5	18.5	26.5	22.5	MKP1J031805F
0.22 "	9	16	18	15	MKP1G032204J	8.5	18.5	26.5	22.5	MKP1J032205F
	7	16.5	26.5	22.5	MKP1G032205D	9	19	31.5	27.5	MKP1J032206A
0.27 "	8.5	18.5	26.5	22.5	MKP1G032705F	11	21	26.5	22.5	MKP1J032705I
0.33 "	8.5	18.5	26.5	22.5	MKP1G033305F	11	21	26.5	22.5	MKP1J033305I
	9	19	31.5	27.5	MKP1G033306A	11	21	31.5	27.5	MKP1J033306B
0.39 "	10.5	19	26.5	22.5	MKP1G033905G	11	21	31.5	27.5	MKP1J033906B
0.47 "	10.5	19	26.5	22.5	MKP1G034705G	11	21	31.5	27.5	MKP1J034706B
	9	19	31.5	27.5	MKP1G034706A					
0.56 "	11	21	26.5	22.5	MKP1G035605I	15	26	31.5	27.5	MKP1J035606F
0.68 "	11	21	26.5	22.5	MKP1G036805I	15	26	31.5	27.5	MKP1J036806F
	11	21	31.5	27.5	MKP1G036806B	13	24	41.5	37.5	MKP1J036807C
0.82 "	13	24	31.5	27.5	MKP1G038206D	17	29	31.5	27.5	MKP1J038206G
1.0 μ F	13	24	31.5	27.5	MKP1G041006D	17	29	31.5	27.5	MKP1J041006G
						15	26	41.5	37.5	MKP1J041007D
1.2 "	17	29	31.5	27.5	MKP1G041206G	20	39.5	31.5	27.5	MKP1J041206J
1.5 "	17	29	31.5	27.5	MKP1G041506G	20	39.5	31.5	27.5	MKP1J041506J
	13	24	41.5	37.5	MKP1G041507C	19	32	41.5	37.5	MKP1J041507F
1.8 "	20	39.5	31.5	27.5	MKP1G041806J	20	39.5	41.5	37.5	MKP1J041807G
2.2 "	20	39.5	31.5	27.5	MKP1G042206J	20	39.5	41.5	37.5	MKP1J042207G
	17	29	41.5	37.5	MKP1G042207E					
2.7 "	20	39.5	41.5	37.5	MKP1G042707G	24	45.5	41.5	37.5	MKP1J042707H
3.3 "	20	39.5	41.5	37.5	MKP1G043307G	24	45.5	41.5	37.5	MKP1J043307H
						28	38	41.5	37.5	MKP1J043307L
3.9 "	20	39.5	41.5	37.5	MKP1G043907G	35	50	41.5	37.5	MKP1J043907J
4.7 "	20	39.5	41.5	37.5	MKP1G044707G	35	50	41.5	37.5	MKP1J044707J
5.6 "	24	45.5	41.5	37.5	MKP1G045607H	40	55	41.5	37.5	MKP1J045607K
6.8 "	24	45.5	41.5	37.5	MKP1G046807H	40	55	41.5	37.5	MKP1J046807K
	28	38	41.5	37.5	MKP1G046807L	35	50	57	52.5	MKP1J046809F
8.2 "	35	50	41.5	37.5	MKP1G048207J	45	55	57	52.5	MKP1J048209H
10 μ F	35	50	41.5	37.5	MKP1G051007J	45	55	57	52.5	MKP1J051009H
	35	50	57	52.5	MKP1G051009F					
12 "	40	55	41.5	37.5	MKP1G051207K					
15 "	40	55	41.5	37.5	MKP1G051507K					
	35	50	57	52.5	MKP1G051509F					
18 "	45	65	57	52.5	MKP1G051809J					
22 "	45	65	57	52.5	MKP1G052209J					

* AC voltage: $f \leq 1000 \text{ Hz}$; $1.4 \times U_{\text{rms}} + U_{\text{DC}} \leq U_{\text{r}}$

** PCM = Printed circuit module = pin spacing

Dims. in mm.

Ionisation inception level in isolated cases may be lower than admissible rated AC voltage.

Part number completion:

Version code:	2-pin	= 00
	4-pin	= D4
Tolerance:	20 %	= M
	10 %	= K
	5 %	= J
Packing:	bulk	= S
Pin length:	6-2	= SD
Taped version see page 157.		

Rights reserved to amend design data without prior notification.

Continuation page 71

Continuation

General Data

Capacitance	850 VDC/450 VAC*					1000 VDC/600 VAC*				
	W	H	L	PCM**	Part number	W	H	L	PCM**	Part number
1000 pF	4	9	10	7.5	MKP1M011002C	4	9	10	7.5	MKP1O111002C
	4	9	13	10	MKP1M011003C	4	9	13	10	MKP1O111003C
1200 "	4	9	10	7.5	MKP1M011202C	4	9	10	7.5	MKP1O111202C
1500 "	4	9	10	7.5	MKP1M011502C	4	9	10	7.5	MKP1O111502C
	4	9	13	10	MKP1M011503C	4	9	13	10	MKP1O111503C
1800 "	4	9	10	7.5	MKP1M011802C	4	9	10	7.5	MKP1O111802C
2200 "	4	9	10	7.5	MKP1M012202C	4	9	10	7.5	MKP1O112202C
	4	9	13	10	MKP1M012203C	4	9	13	10	MKP1O112203C
2700 "	4	9	10	7.5	MKP1M012702C	4	9	10	7.5	MKP1O112702C
3300 "	4	9	10	7.5	MKP1M013302C	4	9	10	7.5	MKP1O113302C
	4	9	13	10	MKP1M013303C	4	9	13	10	MKP1O113303C
3900 "	4.5	9.5	10.3	7.5	MKP1M013902D	4.5	9.5	10.3	7.5	MKP1O113902D
4700 "	4.5	9.5	10.3	7.5	MKP1M014702D	4.5	9.5	10.3	7.5	MKP1O114702D
	4	9	13	10	MKP1M014703C	4	9	13	10	MKP1O114703C
5600 "	5.7	12.5	10.3	7.5	MKP1M015602F	5.7	12.5	10.3	7.5	MKP1O115602F
6800 "	5.7	12.5	10.3	7.5	MKP1M016802F	5.7	12.5	10.3	7.5	MKP1O116802F
	5	11	13	10	MKP1M016803F	5	11	13	10	MKP1O116803F
8200 "	5	11	13	10	MKP1M018203F	5	11	13	10	MKP1O118203F
0.01 µF	5	11	13	10	MKP1M021003F	5	11	13	10	MKP1O121003F
	5	11	18	15	MKP1M021004B	5	11	18	15	MKP1O121004B
0.012 "	6	12	13	10	MKP1M021203G	6	12	13	10	MKP1O121203G
0.015 "	6	12	13	10	MKP1M021503G	6	12	13	10	MKP1O121503G
	5	11	18	15	MKP1M021504B	5	11	18	15	MKP1O121504B
0.018 "	6	12.5	18	15	MKP1M021804C	6	12.5	18	15	MKP1O121804C
0.022 "	6	12.5	18	15	MKP1M022204C	6	12.5	18	15	MKP1O122204C
	6	15	26.5	22.5	MKP1M022205B	6	15	26.5	22.5	MKP1O122205B
0.027 "	7	14	18	15	MKP1M022704D	7	14	18	15	MKP1O122704D
0.033 "	7	14	18	15	MKP1M023304D	7	14	18	15	MKP1O123304D
	6	15	26.5	22.5	MKP1M023305B	6	15	26.5	22.5	MKP1O123305B
0.039 "	8	15	18	15	MKP1M023904F	8	15	18	15	MKP1O123904F
0.047 "	8	15	18	15	MKP1M024704F	8	15	18	15	MKP1O124704F
	6	15	26.5	22.5	MKP1M024705B	6	15	26.5	22.5	MKP1O124705B
0.056 "	7	16.5	26.5	22.5	MKP1M025605D	7	16.5	26.5	22.5	MKP1O125605D
0.068 "	7	16.5	26.5	22.5	MKP1M026805D	7	16.5	26.5	22.5	MKP1O126805D
0.08 "	7	16.5	26.5	22.5	MKP1M028205D	8.5	18.5	26.5	22.5	MKP1O128205F
0.1 µF	7	16.5	26.5	22.5	MKP1M031005D	8.5	18.5	26.5	22.5	MKP1O131005F
	11	21	31.5	27.5	MKP1M031006B	11	21	31.5	27.5	MKP1O131006B
0.12 "	8.5	18.5	26.5	22.5	MKP1M031205F	11	21	26.5	22.5	MKP1O131205I
0.15 "	8.5	18.5	26.5	22.5	MKP1M031505F	11	21	26.5	22.5	MKP1O131505I
	11	21	31.5	27.5	MKP1M031506B	11	21	31.5	27.5	MKP1O131506B
0.18 "	11	21	26.5	22.5	MKP1M031805I	11	21	31.5	27.5	MKP1O131806B
0.22 "	11	21	26.5	22.5	MKP1M032205I	11	21	31.5	27.5	MKP1O132206B
	11	21	31.5	27.5	MKP1M032206B					
0.27 "	11	21	31.5	27.5	MKP1M033306B	15	26	31.5	27.5	MKP1O132706F
0.33 "	15	26	31.5	27.5	MKP1M033306F	15	26	31.5	27.5	MKP1O133306F
	13	24	41.5	37.5	MKP1M033307C	13	24	41.5	37.5	MKP1O133307C
0.39 "	17	29	31.5	27.5	MKP1M033906G	17	29	31.5	27.5	MKP1O133906G
0.47 "	17	29	31.5	27.5	MKP1M034706G	17	29	31.5	27.5	MKP1O134706G
	13	24	41.5	37.5	MKP1M034707C	13	24	41.5	37.5	MKP1O134707C
0.56 "	17	29	41.5	37.5	MKP1M035607E	20	39.5	31.5	27.5	MKP1O135606J
0.68 "	20	39.5	31.5	27.5	MKP1M036806J	20	39.5	31.5	27.5	MKP1O136806J
	17	29	41.5	37.5	MKP1M036807E	17	29	41.5	37.5	MKP1O136807E
0.82 "	19	32	41.5	37.5	MKP1M038207F	20	39.5	41.5	37.5	MKP1O138207G

* AC voltage: $f \leq 1000 \text{ Hz}$; $1.4 \times U_{\text{rms}} + U_{\text{DC}} \leq U_{\text{r}}$

** PCM = Printed circuit module = pin spacing

Dims. in mm.

Ionisation inception level in isolated cases may be lower than admissible rated AC voltage.

Rights reserved to amend design data without prior notification.

Continuation

General Data

Capacitance	1600 VDC/650 VAC*					2000 VDC/700 VAC*				
	W	H	L	PCM**	Part number	W	H	L	PCM**	Part number
0.1 μ F	11	21	26.5	22.5	MKP1T031005L_____	13	24	31.5	27.5	MKP1U031006D_____
	11	21	31.5	27.5	MKP1T031006B_____					
0.12 "	13	24	31.5	27.5	MKP1T031206D_____	15	26	31.5	27.5	MKP1U031206F_____
0.15 "	13	24	31.5	27.5	MKP1T031506D_____	15	26	31.5	27.5	MKP1U031506F_____
						13	24	41.5	37.5	MKP1U031507C_____
0.18 "	15	26	31.5	27.5	MKP1T031806F_____	17	34.5	31.5	27.5	MKP1U031806I_____
						15	26	31.5	27.5	MKP1T032206F_____
0.22 "	13	24	41.5	37.5	MKP1T032207C_____	17	29	41.5	37.5	MKP1U032207E_____
						17	34.5	31.5	27.5	MKP1T032706I_____
0.27 "	17	34.5	31.5	27.5	MKP1T033306L_____	19	32	41.5	37.5	MKP1U033307F_____
0.33 "	17	29	41.5	37.5	MKP1T033307E_____	20	39.5	41.5	37.5	MKP1U033907G_____
0.39 "	20	39.5	31.5	27.5	MKP1T033906J_____	19	32	41.5	37.5	MKP1T034707F_____
0.47 "	19	32	41.5	37.5	MKP1T035607G_____					
0.56 "	20	39.5	41.5	37.5	MKP1T036807G_____	24	45.5	41.5	37.5	MKP1U036807H_____
						24	45.5	41.5	37.5	MKP1U036807L_____
0.68 "	20	39.5	41.5	37.5	MKP1T038207H_____	28	38	41.5	37.5	MKP1U036807L_____
						35	50	41.5	37.5	MKP1U038207J_____
1.0 μ F	24	45.5	41.5	37.5	MKP1T041007H_____	35	50	41.5	37.5	MKP1U041007J_____
	28	38	41.5	37.5	MKP1T041007L_____					
1.2 "	31	46	41.5	37.5	MKP1T041207I_____	40	55	41.5	37.5	MKP1U041207K_____
1.5 "	31	46	41.5	37.5	MKP1T041507I_____	40	55	41.5	37.5	MKP1U041507K_____
						35	50	57	52.5	MKP1U041509F_____
1.8 "	40	55	41.5	37.5	MKP1T041807K_____	45	55	57	52.5	MKP1U041809H_____
2.2 "	40	55	41.5	37.5	MKP1T042207K_____	45	55	57	52.5	MKP1U042209H_____
						35	50	57	52.5	MKP1T042209F_____
2.7 "	45	65	57	52.5	MKP1T042709J_____					
3.3 "	45	65	57	52.5	MKP1T043309J_____					

Capacitance	2500 VDC/700 VAC*					Part number	Dims. in mm.
	W	H	L	PCM**			
1000 pF	5	11	18	15	MKP1V011004B_____	Ionisation inception level in isolated cases may be lower than admissible rated AC voltage.	
	6	15	26.5	22.5	MKP1V011005B_____		
1200 "	5	11	18	15	MKP1V011204B_____		
1500 "	5	11	18	15	MKP1V011504B_____		
							6
1800 "	5	11	18	15	MKP1V011804B_____		
2200 "	5	11	18	15	MKP1V012204B_____		
							6
2700 "	5	11	18	15	MKP1V012704B_____		
3300 "	5	11	18	15	MKP1V013304B_____		
							6
3900 "	6	12.5	18	15	MKP1V013904C_____		
4700 "	6	12.5	18	15	MKP1V014704C_____		
							6
5600 "	7	14	18	15	MKP1V015604D_____		
6800 "	7	14	18	15	MKP1V016804D_____		
						7	16.5
8200 "	8.5	18.5	26.5	22.5	MKP1V018205F_____		

Part number completion:	
Version code:	2-pin = 00
	4-pin = D4
Tolerance:	20 % = M
	10 % = K
	5 % = J
Packing:	bulk = S
Pin length:	6-2 = SD
Taped version see page 157.	

* AC voltage: $f \leq 1000 \text{ Hz}$; $1.4 \times U_{\text{rms}} + \text{UDC} \leq U_r$

** PCM = Printed circuit module = pin spacing

Rights reserved to amend design data without prior notification.

Continuation page 74

Continuation

General Data

Capacitance	2500 VDC/700 VAC*					3000 VDC/700 VAC*				
	W	H	L	PCM**	Part number	W	H	L	PCM**	Part number
0.01 µF	8.5	18.5	26.5	22.5	MKP1V021005F	8.5	18.5	26.5	22.5	MKP1W021005F
0.012 "	10.5	19	26.5	22.5	MKP1V021205G	10.5	19	26.5	22.5	MKP1W021205G
0.015 "	10.5	19	26.5	22.5	MKP1V021505G	10.5	19	26.5	22.5	MKP1W021505G
0.018 "	11	21	26.5	22.5	MKP1V021805L	11	21	26.5	22.5	MKP1W021805L
0.022 "	11	21	26.5	22.5	MKP1V022205I	11	21	26.5	22.5	MKP1W022205I
0.027 "	11	21	26.5	22.5	MKP1V022705I	11	21	26.5	22.5	MKP1W022705I
0.033 "	11	21	26.5	22.5	MKP1V023305L	11	21	26.5	22.5	MKP1W023305L
	9	19	31.5	27.5	MKP1V023306A	9	19	31.5	27.5	MKP1W023306A
0.039 "	11	21	31.5	27.5	MKP1V023906B	11	21	31.5	27.5	MKP1W023906B
0.047 "	11	21	31.5	27.5	MKP1V024706B	11	21	31.5	27.5	MKP1W024706B
0.056 "	13	24	31.5	27.5	MKP1V025606D	13	24	31.5	27.5	MKP1W025606D
0.068 "	13	24	31.5	27.5	MKP1V026806D	13	24	31.5	27.5	MKP1W026806D
0.082 "	15	26	31.5	27.5	MKP1V028206F	15	26	31.5	27.5	MKP1W028206F
0.1 µF	15	26	31.5	27.5	MKP1V031006F	15	26	31.5	27.5	MKP1W031006F
	13	24	41.5	37.5	MKP1V031007C	13	24	41.5	37.5	MKP1W031007C
0.12 "	17	34.5	31.5	27.5	MKP1V031206L	17	34.5	31.5	27.5	MKP1W031206L
0.15 "	17	34.5	31.5	27.5	MKP1V031506I	17	34.5	31.5	27.5	MKP1W031506I
	15	26	41.5	37.5	MKP1V031507D	15	26	41.5	37.5	MKP1W031507D
0.18 "	19	32	41.5	37.5	MKP1V031807F	19	32	41.5	37.5	MKP1W031807F
0.22 "	19	32	41.5	37.5	MKP1V032207F	19	32	41.5	37.5	MKP1W032207F
0.27 "	24	45.5	41.5	37.5	MKP1V032707H	24	45.5	41.5	37.5	MKP1W032707H
0.33 "	24	45.5	41.5	37.5	MKP1V033307H	24	45.5	41.5	37.5	MKP1W033307H
	28	38	41.5	37.5	MKP1V033307L	28	38	41.5	37.5	MKP1W033307L
0.39 "	31	46	41.5	37.5	MKP1V033907I	31	46	41.5	37.5	MKP1W033907I
0.47 "	31	46	41.5	37.5	MKP1V034707L	31	46	41.5	37.5	MKP1W034707L
0.56 "	35	50	41.5	37.5	MKP1V035607J	35	50	41.5	37.5	MKP1W035607J
0.68 "	35	50	41.5	37.5	MKP1V036807J	35	50	41.5	37.5	MKP1W036807J
0.82 "	40	55	41.5	37.5	MKP1V038207K	40	55	41.5	37.5	MKP1W038207K
1.0 µF	40	55	41.5	37.5	MKP1V041007K	40	55	41.5	37.5	MKP1W041007K
	35	50	57	52.5	MKP1V041009F	35	50	57	52.5	MKP1W041009F
1.2 "	45	55	57	52.5	MKP1V041209H	45	55	57	52.5	MKP1W041209H
1.5 "	45	55	57	52.5	MKP1V041509H	45	55	57	52.5	MKP1W041509H

* AC voltage: $f \leq 1000 \text{ Hz}$; $1.4 \times U_{\text{rms}} + \text{UDC} \leq U_r$

** PCM = Printed circuit module = pin spacing

Dims. in mm.

Ionisation inception level in isolated cases may be lower than admissible rated AC voltage.

Part number completion:	
Version code:	2-pin = 00 4-pin = D4
Tolerance:	20 % = M 10 % = K 5 % = J
Packing:	bulk = S
Pin length:	6-2 = SD
Taped version see page 157.	

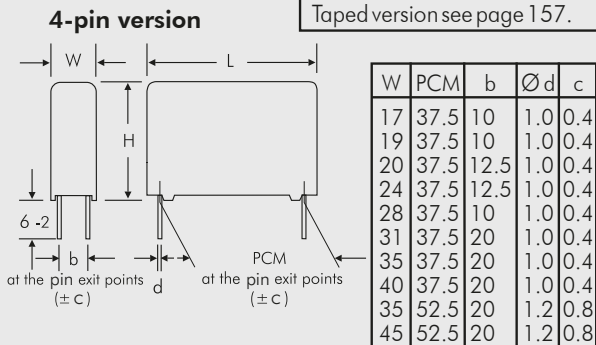
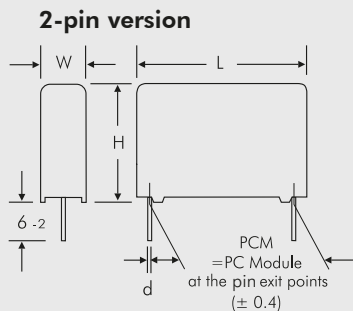

Rights reserved to amend design data without prior notification.

Continuation page 75

Continuation

Impedance change with frequency
(general guide).

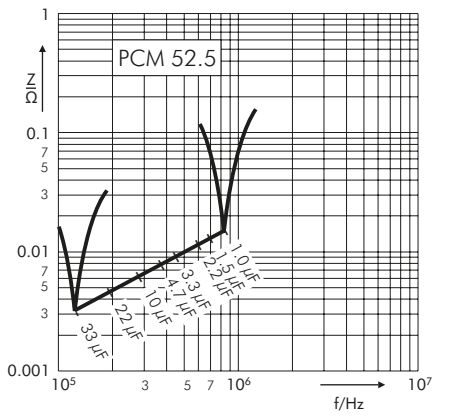
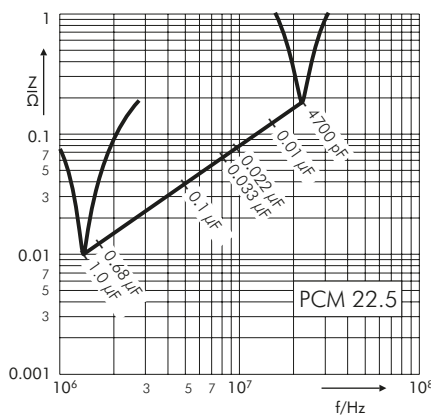
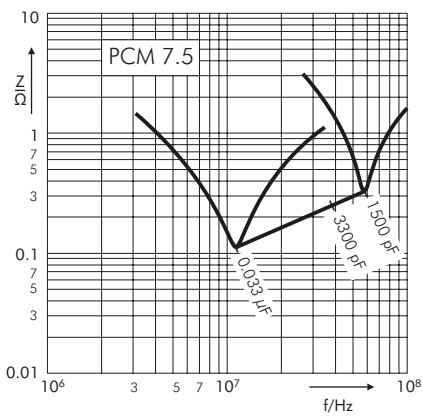
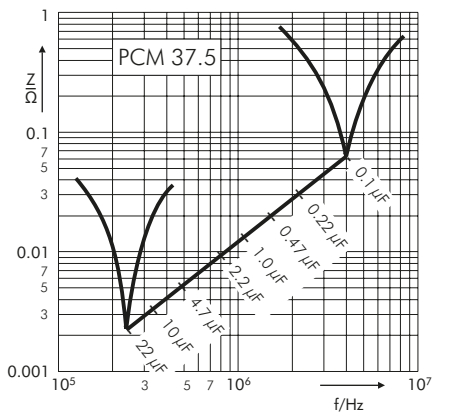
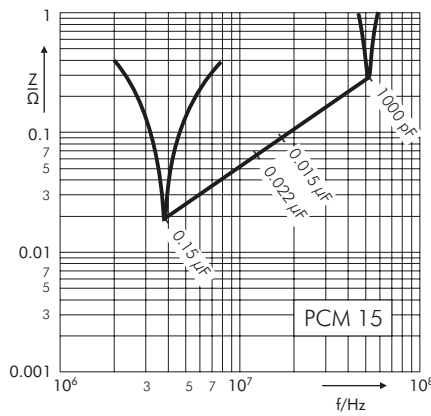
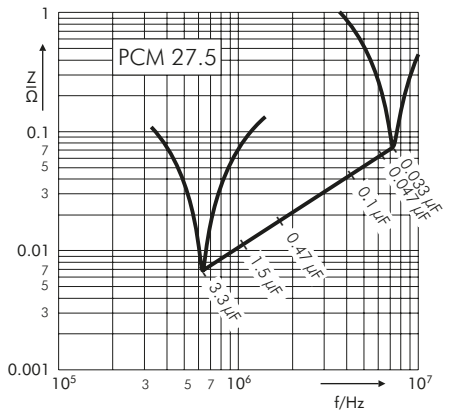
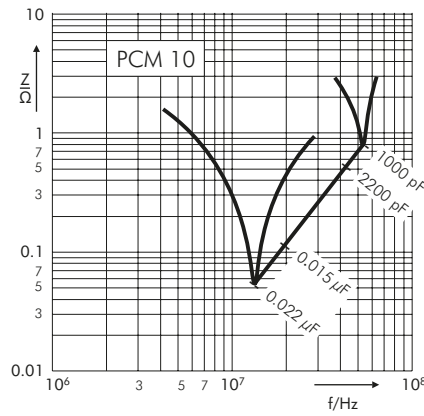

Continuation

Permissible AC voltage in relation to frequency till 15° C internal temperature rise (general guide).

The information behind the cross bar denote the PCM of the measured value.

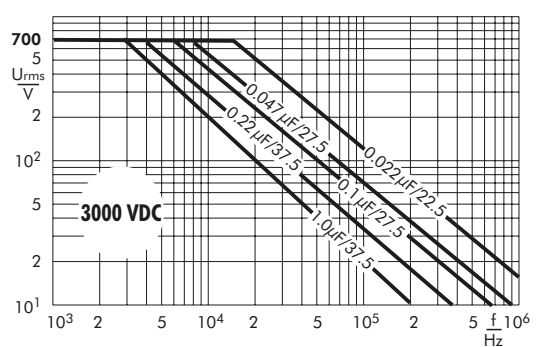
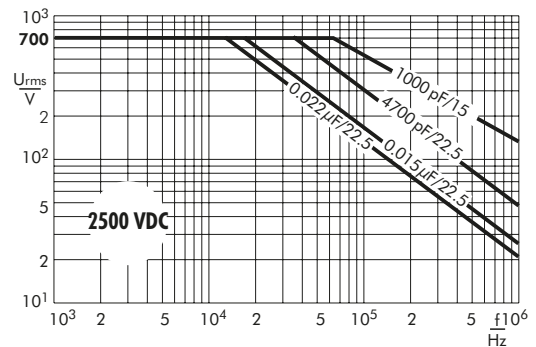
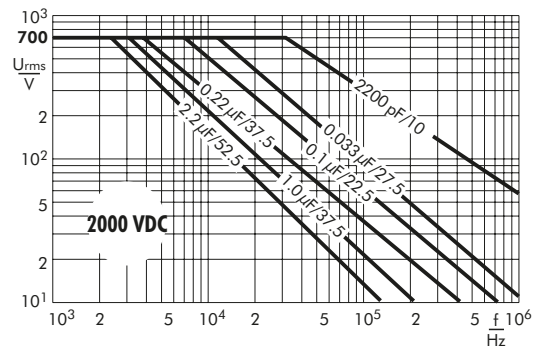
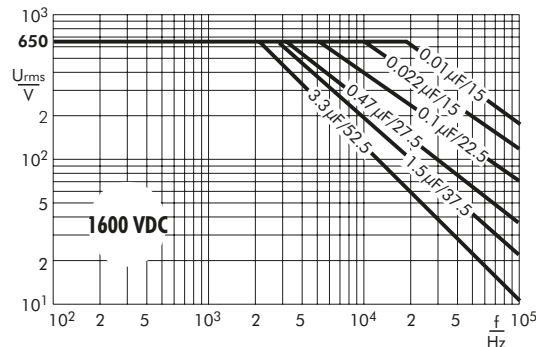
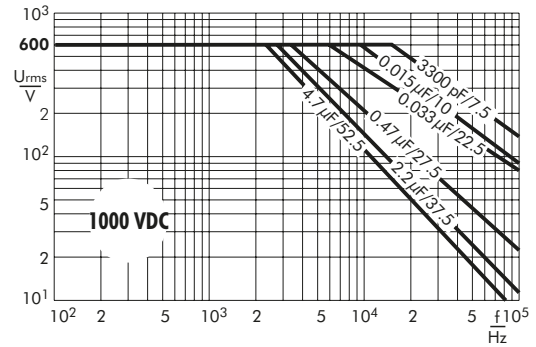
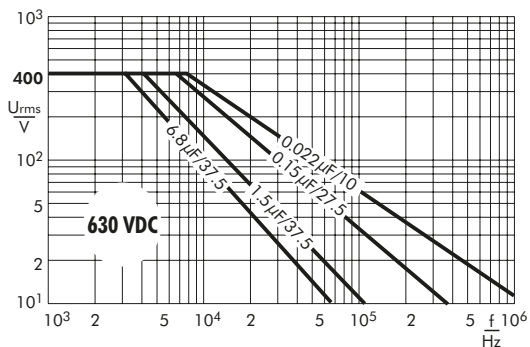
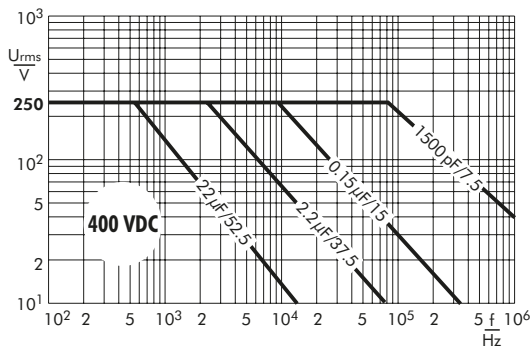
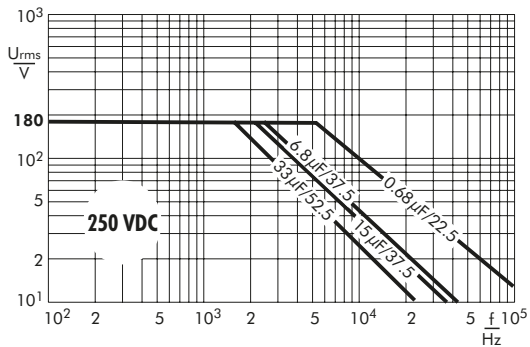
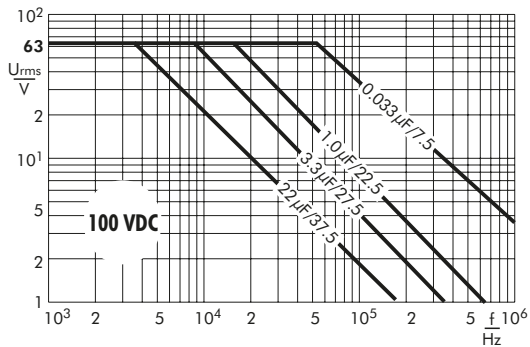

WIMA MKP 10



Continuation

Permissible AC current in relation to frequency till 15° C internal temperature rise (general guide).

The information behind the cross bar denote the PCM of the measured value.

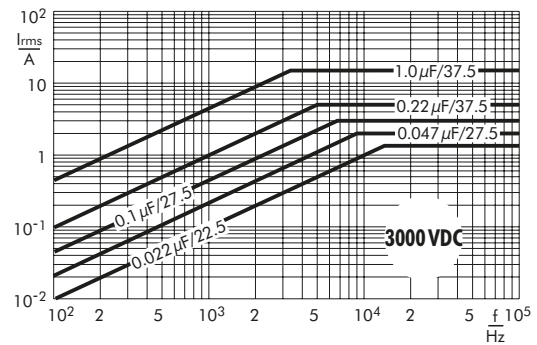
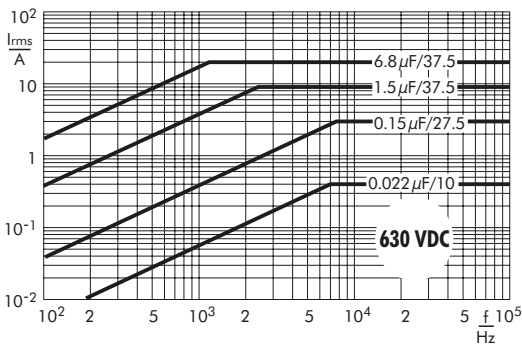
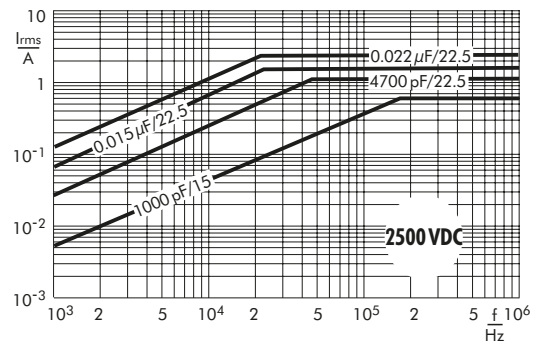
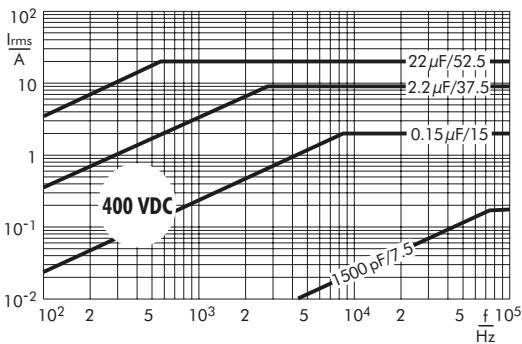
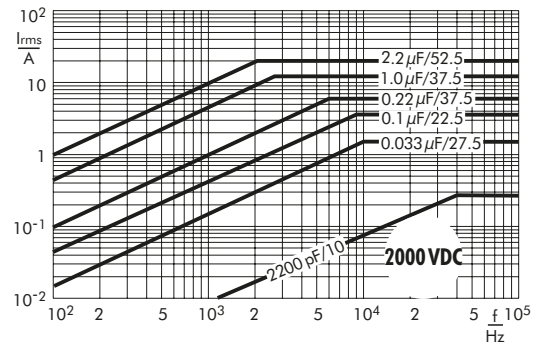
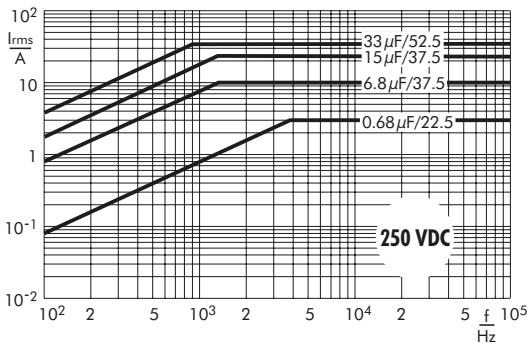
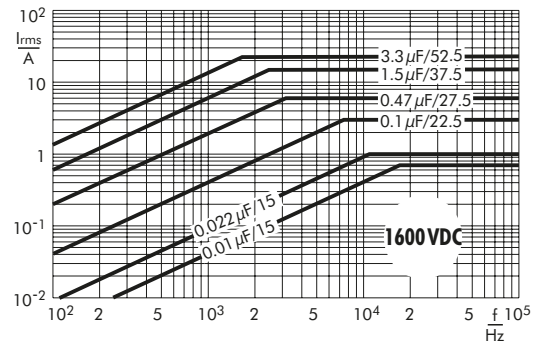
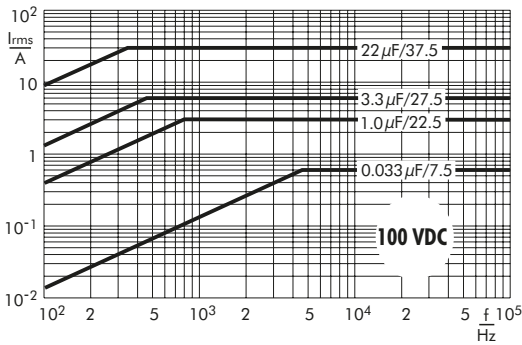
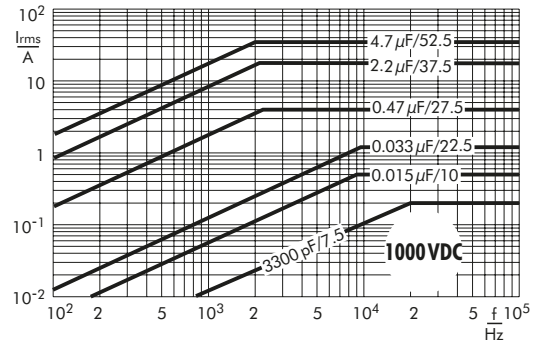

Polypropylene (PP) Capacitors for High Pulse Applications with Metal Foil Electrodes and Metallized Internal Series Connection in PCM 15 mm to 37.5 mm. Capacitances from 100 pF to 4.7 μ F. Rated Voltages from 400 VDC to 2000 VDC.

Special Features

- High pulse duty
- Self-healing
- Internal series connection
- Very low dissipation factor
- Negative capacitance change versus temperature
- Smaller box sizes than FKP 1
- AEC-Q200 qualified
- According to RoHS 2015/863/EU

Typical Applications

For high pulse and high frequency applications e.g.

- Switch mode power supplies
- Converter in drives and power electronics
- Deflection systems in monitors and TV-sets
- Electronic ballasts

Construction

Dielectric:

Polypropylene (PP) film

Capacitor electrodes:

Aluminium foil and single-sided metallized plastic film

Internal construction:

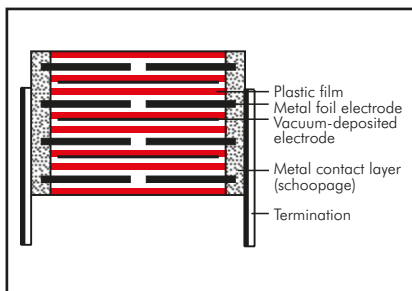

Encapsulation:

Solvent-resistant, flame-retardant plastic case with epoxy resin seal, UL 94 V-0

Terminations:

Tinned wire.

Marking:

Colour: Red. Marking: Black.

Electrical Data

Capacitance range:

100 pF to 4.7 μ F (E12-values on request)

Rated voltages:

400 VDC, 630 VDC, 1000 VDC, 1250 VDC, 1600 VDC, 2000 VDC

Capacitance tolerances:

$\pm 20\%$, $\pm 10\%$, $\pm 5\%$ (other tolerances are available subject to special enquiry)

Operating temperature range:

-55° C to $+105^{\circ}$ C

Climatic test category:

55/100/56 in accordance with IEC

Insulation resistance at $+20^{\circ}$ C:

$C \leq 0.1 \mu\text{F}$: $\geq 1 \times 10^5 \text{ M}\Omega$

$C > 0.1 \mu\text{F}$: $\geq 10000 \text{ sec (M}\Omega \times \mu\text{F)}$

Measuring voltage: 100 V/1 min.

Dissipation factors at $+20^{\circ}$ C: $\tan \delta$

at f	$C \leq 0.1 \mu\text{F}$	$0.1 \mu\text{F} < C \leq 1.0 \mu\text{F}$	$C > 1.0 \mu\text{F}$
1 kHz	$\leq 5 \times 10^{-4}$	$\leq 5 \times 10^{-4}$	$\leq 5 \times 10^{-4}$
10 kHz	$\leq 6 \times 10^{-4}$	$\leq 6 \times 10^{-4}$	-
100 kHz	$\leq 10 \times 10^{-4}$	-	-

Test voltage: $2 U_r$, 2 sec.

Dielectric absorption:

0.05%

Voltage derating:

A voltage derating factor of 1.35 % per K must be applied from $+85^{\circ}$ C for DC voltages and from $+75^{\circ}$ C for AC voltages.

Reliability:

Operational life > 300 000 hours

Failure rate < 1 fit ($0.5 \times U_r$ and 40° C)

Maximum pulse rise time:

Capacitance pF/ μ F	max. pulse rise time V/ μ sec at $T_A < 40^{\circ}$ C					
	400 VDC	630 VDC	1000 VDC	1250 VDC	1600 VDC	2000 VDC
100 ... 220	-	-	-	-	-	39000
330 ... 680	-	-	-	-	-	39000
1000 ... 2200	-	-	-	-	27000	39000
3300 ... 6800	-	-	-	-	17000	21000
0.01 ... 0.022	7000	11000	11000	11000	11000	11000
0.033 ... 0.068	7000	9000	9000	9000	9000	9000
0.1 ... 0.22	6000	9000	9000	9000	9000	9000
0.33 ... 0.68	3000	5000	5000	5000	5000	5000
1.0 ... 4.7	1000	1600	2000	2000	2000	-

Mechanical Tests

Pull test on pins:

$d \leq 0.8 \varnothing$: 10 N in direction of pins

$d > 0.8 \varnothing$: 20 N in direction of pins

according to IEC 60068-2-21

Vibration:

6 hours at 10...2000 Hz and 0.75 mm

displacement amplitude or 10 g in

accordance with IEC 60068-2-6

Low air density:

1 kPa = 10 mbar in accordance with

IEC 60068-2-13

Bump test:

4000 bumps at 390 m/sec^2

in accordance with IEC 60068-2-29

Packing

Available taped and reeled up to and including case size 15 x 26 x 31.5 / PCM 27.5 mm.

Detailed taping information and graphs at the end of the catalogue.

For further details and graphs please refer to Technical Information.

Continuation

General Data

Capacitance	400 VDC/250 VAC*					630 VDC/400 VAC*				
	W	H	L	PCM**	Part number	W	H	L	PCM**	Part number
0.01 µF	5	11	18	15	FKP4G021004B00_____	5	11	18	15	FKP4J021004B00_____
0.015 "	5	11	18	15	FKP4G021504B00_____	6	12.5	18	15	FKP4J021504C00_____
0.022 "	6	12.5	18	15	FKP4G022204C00_____	7	14	18	15	FKP4J022204D00_____
0.033 "	7	14	18	15	FKP4G023304D00_____	8	15	18	15	FKP4J023304F00_____
0.047 "	8	15	18	15	FKP4G024704F00_____	6	15	26.5	22.5	FKP4J023305B00_____
	6	15	26.5	22.5	FKP4G024705B00_____	9	16	18	15	FKP4J024704J00_____
0.068 "	7	16.5	26.5	22.5	FKP4G026805D00_____	7	16.5	26.5	22.5	FKP4J024705D00_____
	8.5	18.5	26.5	22.5	FKP4G031005F00_____	8.5	18.5	26.5	22.5	FKP4J026805F00_____
0.1 µF	8.5	18.5	26.5	22.5	FKP4G031005F00_____	10.5	19	26.5	22.5	FKP4J031005G00_____
0.15 "	11	21	26.5	22.5	FKP4G031505I00_____	11	21	31.5	27.5	FKP4J031006B00_____
	9	19	31.5	27.5	FKP4G031506A00_____	11	21	26.5	22.5	FKP4J031505I00_____
0.22 "	11	21	31.5	27.5	FKP4G032206B00_____	11	21	31.5	27.5	FKP4J031506B00_____
	13	24	31.5	27.5	FKP4G033306D00_____	13	24	31.5	27.5	FKP4J032206D00_____
0.33 "	13	24	31.5	27.5	FKP4G033306D00_____	15	26	31.5	27.5	FKP4J033306F00_____
0.47 "	17	29	31.5	27.5	FKP4G034706G00_____	17	34.5	31.5	27.5	FKP4J034706I00_____
0.68 "	17	34.5	31.5	27.5	FKP4G036806I00_____	17	34.5	31.5	27.5	FKP4J036806I00_____
	19	32	41.5	37.5	FKP4G036807F00_____	19	32	41.5	37.5	FKP4J036807F00_____
1.0 µF	20	39.5	31.5	27.5	FKP4G041006J00_____	20	39.5	41.5	37.5	FKP4J041007G00_____
1.5 "	20	39.5	41.5	37.5	FKP4G041507G00_____	24	45.5	41.5	37.5	FKP4J041507H00_____
2.2 "	24	45.5	41.5	37.5	FKP4G042207H00_____	31	46	41.5	37.5	FKP4J042207I00_____
3.3 "	31	46	41.5	37.5	FKP4G043307I00_____	40	55	41.5	37.5	FKP4J043307K00_____
4.7 "	40	55	41.5	37.5	FKP4G044707K00_____					

Capacitance	1000 VDC/600 VAC*					1250 VDC/600 VAC*				
	W	H	L	PCM**	Part number	W	H	L	PCM**	Part number
0.01 µF	6	12.5	18	15	FKP4O121004C00_____	9	16	18	15	FKP4R021004J00_____
0.015 "	5	14	26.5	22.5	FKP4O121005A00_____	6	15	26.5	22.5	FKP4R021005B00_____
	7	14	18	15	FKP4O121504D00_____	7	16.5	26.5	22.5	FKP4R021505D00_____
0.022 "	6	15	26.5	22.5	FKP4O121505B00_____					
	8	15	18	15	FKP4O122204F00_____	8.5	18.5	26.5	22.5	FKP4R022205F00_____
0.033 "	6	15	26.5	22.5	FKP4O122205B00_____					
	7	16.5	26.5	22.5	FKP4O123305D00_____	10.5	19	26.5	22.5	FKP4R023305G00_____
0.047 "	8.5	18.5	26.5	22.5	FKP4O124705F00_____	9	19	31.5	27.5	FKP4R023306A00_____
	9	19	31.5	27.5	FKP4O124706A00_____	11	21	31.5	27.5	FKP4R024706B00_____
0.068 "	11	21	26.5	22.5	FKP4O126805I00_____	13	24	31.5	27.5	FKP4R026806D00_____
	9	19	31.5	27.5	FKP4O126806A00_____					
0.1 µF	11	21	31.5	27.5	FKP4O131006B00_____	15	26	31.5	27.5	FKP4R031006F00_____
0.15 "	13	24	31.5	27.5	FKP4O131506D00_____	15	26	31.5	27.5	FKP4R031506F00_____
0.22 "	15	26	31.5	27.5	FKP4O132206F00_____	20	39.5	31.5	27.5	FKP4R032206J00_____
						17	29	41.5	37.5	FKP4R032207E00_____
0.33 "	17	34.5	31.5	27.5	FKP4O133306I00_____	19	32	41.5	37.5	FKP4R033307F00_____
	19	32	41.5	37.5	FKP4O133307F00_____					
0.47 "	20	39.5	41.5	37.5	FKP4O134707G00_____	20	39.5	41.5	37.5	FKP4R034707G00_____
0.68 "	24	45.5	41.5	37.5	FKP4O136807H00_____	24	45.5	41.5	37.5	FKP4R036807H00_____
1.0 µF	31	46	41.5	37.5	FKP4O141007I00_____	31	46	41.5	37.5	FKP4R041007I00_____
1.5 "	35	50	41.5	37.5	FKP4O141507J00_____	35	50	41.5	37.5	FKP4R041507J00_____
2.2 "	35	50	41.5	37.5	FKP4O142207J00_____					

* AC voltage: $f = 1000 \text{ Hz}; 1.4 \times U_{\text{rms}} + \text{UDC} \leq U_r$

** PCM = Printed circuit module
= pin spacing

Dims. in mm.

Ionisation inception level in isolated cases
may be lower than admissible rated AC voltage.

Ø d	PCM
0.8	15 - 27.5
1.0	37.5

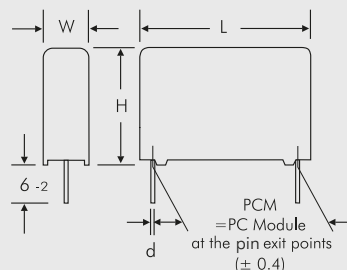

Part number completion:	
Tolerance:	20 % = M
	10 % = K
	5 % = J
Packing:	bulk = S
Pin length:	6-2 = SD
Taped version see page 157.	

Rights reserved to amend design data without prior notification.

Continuation

General Data

Capacitance	1600 VDC/650 VAC*					2000 VDC/700 VAC*				
	W	H	L	PCM**	Part number	W	H	L	PCM**	Part number
100 pF						5	11	18	15	FKP4U001004B00_____
150 "						5	11	18	15	FKP4U001504B00_____
220 "						5	11	18	15	FKP4U002204B00_____
330 "						5	11	18	15	FKP4U003304B00_____
470 "						5	11	18	15	FKP4U004704B00_____
680 "						5	11	18	15	FKP4U006804B00_____
1000 pF	5	11	18	15	FKP4T011004B00_____	5	11	18	15	FKP4U011004B00_____
1500 "	5	11	18	15	FKP4T011504B00_____	6	12.5	18	15	FKP4U011504C00_____
2200 "	6	12.5	18	15	FKP4T012204C00_____	7	14	18	15	FKP4U012204D00_____
3300 "	7	14	18	15	FKP4T013304D00_____	9	16	18	15	FKP4U013304J00_____
4700 "	8	15	18	15	FKP4T014704F00_____	6	15	26.5	22.5	FKP4U013305B00_____
6800 "	9	16	18	15	FKP4T016804J00_____	7	16.5	26.5	22.5	FKP4U014705D00_____
0.01 μF	6	15	26.5	22.5	FKP4T021005B00_____	10.5	19	26.5	22.5	FKP4U021005G00_____
0.015 "	8.5	18.5	26.5	22.5	FKP4T021505F00_____	11	21	26.5	22.5	FKP4U021505I00_____
0.022 "	10.5	19	26.5	22.5	FKP4T022205H00_____	9	19	31.5	27.5	FKP4U021506A00_____
0.033 "	9	19	31.5	27.5	FKP4T022206A00_____	11	21	31.5	27.5	FKP4U022206B00_____
0.047 "	11	21	31.5	27.5	FKP4T023306B00_____	11	22	41.5	37.5	FKP4U022207B00_____
0.068 "	13	24	31.5	27.5	FKP4T024706D00_____	13	24	31.5	27.5	FKP4U023306D00_____
0.1 μF	15	26	31.5	27.5	FKP4T026806F00_____	15	26	31.5	27.5	FKP4U024706F00_____
0.15 "	17	34.5	31.5	27.5	FKP4T031006I00_____	15	26	41.5	37.5	FKP4U024707D00_____
0.22 "	20	39.5	31.5	27.5	FKP4T031506J00_____	17	34.5	31.5	27.5	FKP4U026806I00_____
0.33 "	19	32	41.5	37.5	FKP4T031507F00_____	17	29	41.5	37.5	FKP4U026807E00_____
0.47 "	20	39.5	41.5	37.5	FKP4T032207G00_____	24	45.5	41.5	37.5	FKP4U031007E00_____
0.68 "	24	45.5	41.5	37.5	FKP4T033307H00_____	31	46	41.5	37.5	FKP4U032207H00_____
1.0 μF	31	46	41.5	37.5	FKP4T034707I00_____	31	46	41.5	37.5	FKP4U033307I00_____
	35	50	41.5	37.5	FKP4T036807J00_____	35	50	41.5	37.5	FKP4U034707I00_____
	40	55	41.5	37.5	FKP4T041007K00_____					FKP4U036807J00_____

* AC voltage: $f = 1000 \text{ Hz}$; $1.4 \times U_{\text{rms}} + \text{UDC} \leq U_r$

** PCM = Printed circuit module = pin spacing

Ionisation inception level in isolated cases may be lower than admissible rated AC voltage.

Dims. in mm.

Rights reserved to amend design data without prior notification.

Permissible AC voltage in relation to frequency at 10° C internal temperature rise (general guide).

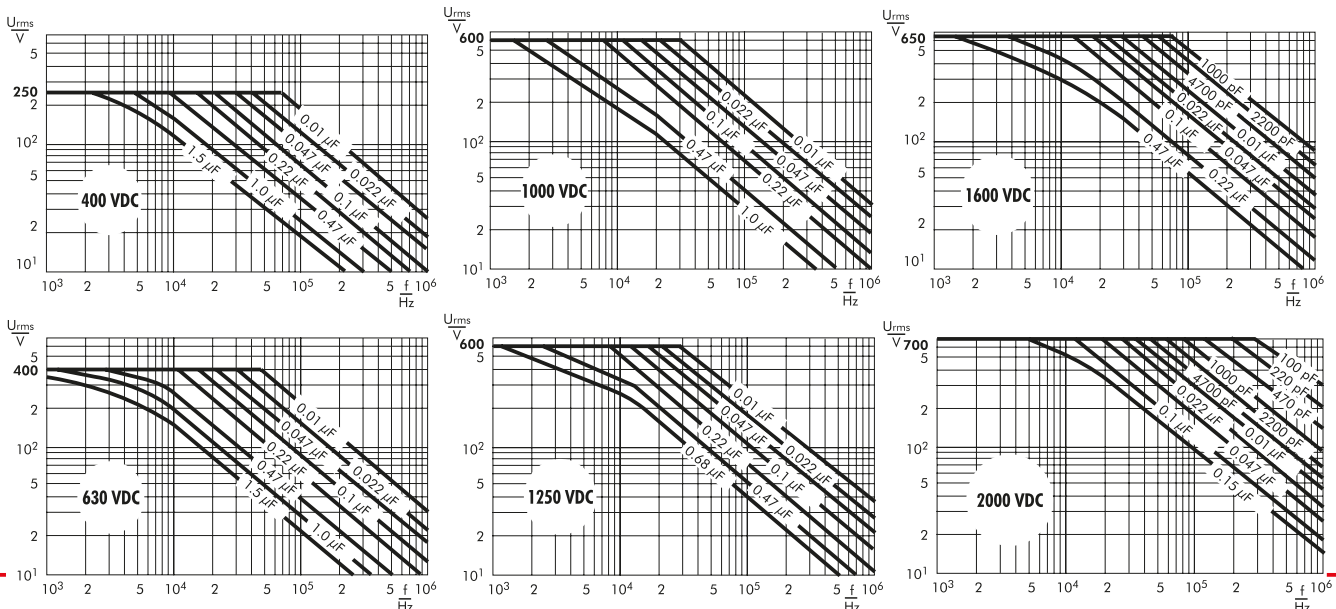

Polypropylene (PP) Capacitors for Very High Pulse Applications with Metal Foil Electrodes and Metallized Internal Series Connection in PCM 15 mm to 52.5 mm. Capacitances from 100 pF to 4.7 μF. Rated Voltages from 400 VDC to 6000 VDC.

Special Features

- Extremely high pulse duty
- Self-healing
- Internal series connection
- Very low dissipation factor
- Negative capacitance change versus temperature
- AEC-Q200 qualified
- According to RoHS 2015/863/EU

Typical Applications

For high pulse and high frequency applications e.g.

- Switch mode power supplies
- Converters in drives and power electronics
- Deflection systems in monitors and TV-sets
- Electronic ballasts

Construction

Dielectric:

Polypropylene (PP) film

Capacitor electrodes:

Aluminium foil and double-sided metallized plastic film

Internal construction:

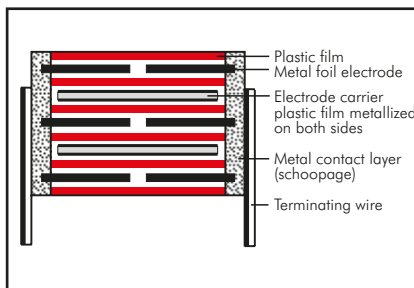

Encapsulation:

Solvent-resistant, flame-retardant plastic case with epoxy resin seal, UL 94 V-0

Terminations:

Tinned wire.

Marking:

Colour: Red. Marking: Black.

Electrical Data

Capacitance range:

100 pF to 4.7 μF (E12-values on request)

Rated voltages:

400 VDC, 630 VDC, 1000 VDC, 1250 VDC, 1600 VDC, 2000 VDC, 4000 VDC, 6000 VDC

Capacitance tolerances:

±20%, ±10%, ±5% (other tolerances are available subject to special enquiry)

Operating temperature range:

-55° C to +105° C

Climatic test category:

55/100/56 in accordance with IEC

Test voltage: 2 sec

PCM	< 4000 VDC	4000 VDC	6000 VDC
< 37.5	2 U _r	2 U _r	1.6 U _r
≥ 37.5	2 U _r	1.6 U _r	1.2 U _r

Dissipation factors at +20° C: tan δ

at f	C ≤ 0.1 μF	0.1 μF < C ≤ 1.0 μF	C > 1.0 μF
1 kHz	≤ 5x10 ⁻⁴	≤ 5x10 ⁻⁴	≤ 5x10 ⁻⁴
10 kHz	≤ 6x10 ⁻⁴	≤ 6x10 ⁻⁴	-
100 kHz	≤ 10x10 ⁻⁴	-	-

Maximum pulse rise time:

Capacitance pF/μF	max. pulse rise time V/μsec at T _A < 40° C							
	400VDC	630VDC	1000VDC	1250VDC	1600VDC	2000VDC	4000VDC	6000VDC
100 ... 220	-	-	-	-	56000	56000	-	-
330 ... 680	-	-	-	-	51000	56000	56000	56000
1000 ... 2200	29000	29000	29000	29000	46000	51000	51000	51000
3300 ... 6800	9000	14000	27000	29000	29000	29000	29000	29000
0.01 ... 0.022	9000	11000	11000	11000	11000	13000	13000	13000
0.033... 0.068	9000	11000	11000	11000	11000	11000	13000	13000
0.1 ... 0.22	7000	11000	11000	11000	11000	11000	13000	13000
0.33 ... 0.68	6000	10000	11000	11000	11000	11000	-	-
1.0 ... 2.2	5000	6600	8300	9500	11000	-	-	-
3.3 ... 4.7	2500	-	-	-	-	-	-	-

Mechanical Tests

Pull test on pins:

d ≤ 0.8 Ø: 10 N in direction of pins
d > 0.8 Ø: 20 N in direction of pins
according to IEC 60068-2-21

Vibration:

6 hours at 10...2000 Hz and 0.75 mm displacement amplitude or 10 g in accordance with IEC 60068-2-6

Low air density:

1kPa = 10 mbar in accordance with IEC 60068-2-13

Bump test:

4000 bumps at 390 m/sec²
in accordance with IEC 60068-2-29

Packing

Available taped and reeled up to and including case size 15 x 26 x 31.5 / PCM 27.5 mm.

Detailed taping information and graphs at the end of the catalogue.

For further details and graphs please refer to Technical Information.

Continuation

General Data

Capacitance	400 VDC/250 VAC*					630 VDC/400 VAC*				
	W	H	L	PCM**	Part number	W	H	L	PCM**	Part number
1000 pF	5	11	18	15	FKP1G011004B	5	11	18	15	FKP1J011004B
1500 "	5	11	18	15	FKP1G011504B	5	11	18	15	FKP1J011504B
2200 "	5	11	18	15	FKP1G012204B	5	11	18	15	FKP1J012204B
3300 "	5	11	18	15	FKP1G013304B	5	11	18	15	FKP1J013304B
4700 "	5	11	18	15	FKP1G014704B	5	11	18	15	FKP1J014704B
6800 "	5	11	18	15	FKP1G016804B	6	12.5	18	15	FKP1J016804C
0.01 µF	5	11	18	15	FKP1G021004B	7	14	18	15	FKP1J021004D
0.015 "	6	12.5	18	15	FKP1G021504C	5	14	26.5	22.5	FKP1J021005A
0.022 "	7	14	18	15	FKP1G022204D	8	15	18	15	FKP1J021504F
0.033 "	5	14	26.5	22.5	FKP1G022205A	6	15	26.5	22.5	FKP1J021505B
0.047 "	8	15	18	15	FKP1G023304F	7	16.5	26.5	22.5	FKP1J022205D
0.068 "	6	15	26.5	22.5	FKP1G023305B	8.5	18.5	26.5	22.5	FKP1J023305F
0.1 µF	7	16.5	26.5	22.5	FKP1G024705D	10.5	20.5	26.5	22.5	FKP1J024705H
0.15 "	8.5	18.5	26.5	22.5	FKP1G026805F	9	19	31.5	27.5	FKP1J024706A
0.22 "	9	19	31.5	27.5	FKP1G031005H	11	21	31.5	27.5	FKP1J026806B
0.33 "	11	21	31.5	27.5	FKP1G031006A	9	19	41.5	37.5	FKP1J026807A
0.47 "	13	24	31.5	27.5	FKP1G031506B	13	24	31.5	27.5	FKP1J031006D
0.68 "	11	22	41.5	37.5	FKP1G032206D	11	22	41.5	37.5	FKP1J031007B
1.0 µF	13	24	31.5	27.5	FKP1G032207B	13	24	41.5	37.5	FKP1J031507C
1.5 "	11	22	41.5	37.5	FKP1G033307C	15	26	41.5	37.5	FKP1J032207D
2.2 "	13	24	41.5	37.5	FKP1G034707E	19	32	41.5	37.5	FKP1J033307F
3.3 "	17	29	41.5	37.5	FKP1G036807F	20	39.5	41.5	37.5	FKP1J034707G
4.7 "	19	32	41.5	37.5	FKP1G041007G	24	45.5	41.5	37.5	FKP1J036807H
1.0 µF	20	39.5	41.5	37.5	FKP1G041507I	35	50	41.5	37.5	FKP1J041007J
1.5 "	31	46	41.5	37.5	FKP1G042207J	40	55	41.5	37.5	FKP1J041507K
2.2 "	35	50	41.5	37.5	FKP1G043309F	35	50	57	52.5	FKP1J041509F
3.3 "	35	50	57	52.5	FKP1G044709J	45	55	57	52.5	FKP1J042209H
4.7 "	45	65	57	52.5						

* AC voltages: $f \leq 1000 \text{ Hz}$; $1.4 \times U_{\text{rms}} + \text{UDC} \leq U_r$

** PCM = Printed circuit module = pin spacing

Dims. in mm.

Ionisation inception level in isolated cases may be lower than admissible rated AC voltage.

Part number completion:

Version code:	2-pin	= 00
	4-pin	= D4
Tolerance:	20 %	= M
	10 %	= K
	5 %	= J
Packing:	bulk	= S
Pin length:	6-2	= SD
Taped version see page 157.		

Rights reserved to amend design data without prior notification.

Continuation page 83

Continuation

General Data

Capacitance	1000 VDC/600 VAC*					Part number
	W	H	L	PCM**		
1000 pF	5	11	18	15	FKP1O111004B	
1500 "	5	11	18	15	FKP1O111504B	
2200 "	5	11	18	15	FKP1O112204B	
3300 "	5	11	18	15	FKP1O113304B	
4700 "	6	12.5	18	15	FKP1O114704C	
6800 "	7	14	18	15	FKP1O116804D	
0.01 µF	8	15	18	15	FKP1O121004F	
	6	15	26.5	22.5	FKP1O121005B	
0.015 "	6	15	26.5	22.5	FKP1O121505B	
0.022 "	8.5	18.5	26.5	22.5	FKP1O122205F	
0.033 "	10.5	20.5	26.5	22.5	FKP1O123305H	
	9	19	31.5	27.5	FKP1O123306A	
0.047 "	11	21	31.5	27.5	FKP1O124706B	
0.068 "	13	24	31.5	27.5	FKP1O126806D	
	11	22	41.5	37.5	FKP1O126807B	
0.1 µF	13	24	41.5	37.5	FKP1O131007C	
0.15 "	15	26	41.5	37.5	FKP1O131507D	
0.22 "	19	32	41.5	37.5	FKP1O132207F	
0.33 "	20	39.5	41.5	37.5	FKP1O133307G	
0.47 "	31	46	41.5	37.5	FKP1O134707I	
0.68 "	35	50	41.5	37.5	FKP1O136807J	
1.0 µF	40	55	41.5	37.5	FKP1O141007K	
	35	50	57	52.5	FKP1O141009F	
1.5 "	45	55	57	52.5	FKP1O141509H	
2.2 "	45	65	57	52.5	FKP1O142209J	

* AC voltages: $f \leq 1000 \text{ Hz}$; $1.4 \times U_{\text{rms}} + U_{\text{DC}} \leq U_r$

** PCM = Printed circuit module = pin spacing

Dims. in mm.

Ionisation inception level in isolated cases may be lower than admissible rated AC voltage.

Part number completion:	
Version code:	2-pin = 00
	4-pin = D4
Tolerance:	20 % = M
	10 % = K
	5 % = J
Packing:	bulk = S
Pin length:	6-2 = SD
Taped version see page 157.	

2-pin version

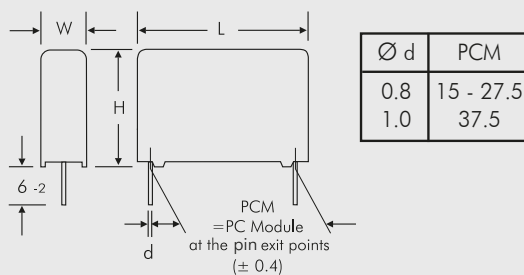

4-pin version

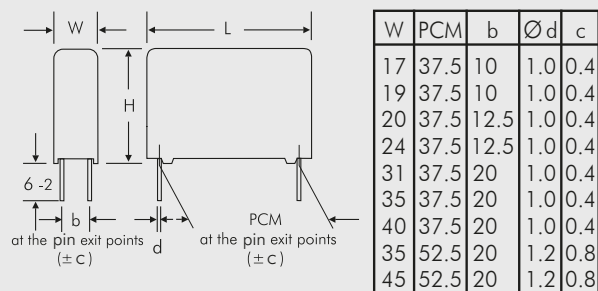

Rights reserved to amend design data without prior notification

Continuation page 84

Continuation

General Data

Capacitance	1250 VDC/600 VAC*					1600 VDC/650 VAC*				
	W	H	L	PCM**	Part number	W	H	L	PCM**	Part number
100 pF						5	11	18	15	FKP1T001004B
150 "						5	11	18	15	FKP1T001504B
220 "						5	11	18	15	FKP1T002204B
330 "						5	11	18	15	FKP1T003304B
470 "						5	11	18	15	FKP1T004704B
680 "						5	11	18	15	FKP1T006804B
1000 pF	5	11	18	15	FKP1R011004B	6	12.5	18	15	FKP1T011004C
1500 "	5	11	18	15	FKP1R011504B	5	14	26.5	22.5	FKP1T011005A
2200 "	5	11	18	15	FKP1R012204B	7	14	18	15	FKP1T011504D
3300 "	5	11	18	15	FKP1R012204B	5	14	26.5	22.5	FKP1T011505A
4700 "	6	12.5	18	15	FKP1R013304C	8	15	18	15	FKP1T012204F
6800 "	7	14	18	15	FKP1R014704D	5	14	26.5	22.5	FKP1T012205A
	8	15	18	15	FKP1R016804F	6	15	26.5	22.5	FKP1T013305B
	5	14	26.5	22.5	FKP1R016805A	7	16.5	26.5	22.5	FKP1T014705D
						8.5	18.5	26.5	22.5	FKP1T016805F
0.01 µF	7	16.5	26.5	22.5	FKP1R021005D	10.5	20.5	26.5	22.5	FKP1T021005H
0.015 "	8.5	18.5	26.5	22.5	FKP1R021505F	11	21	31.5	27.5	FKP1T021506B
0.022 "	10.5	20.5	26.5	22.5	FKP1R022205H	11	21	31.5	27.5	FKP1T022206B
0.033 "	11	21	31.5	27.5	FKP1R023306B	13	24	31.5	27.5	FKP1T023306D
	9	19	41.5	37.5	FKP1R023307A	13	24	41.5	37.5	FKP1T023307C
0.047 "	13	24	31.5	27.5	FKP1R024706D	13	24	41.5	37.5	FKP1T024707C
	11	22	41.5	37.5	FKP1R024707B					
0.068 "	11	22	41.5	37.5	FKP1R026807B	15	26	41.5	37.5	FKP1T026807D
0.1 µF	15	26	41.5	37.5	FKP1R031007D	17	29	41.5	37.5	FKP1T031007E
0.15 "	17	29	41.5	37.5	FKP1R031507E	20	39.5	41.5	37.5	FKP1T031507G
0.22 "	19	32	41.5	37.5	FKP1R032207F	24	45.5	41.5	37.5	FKP1T032207H
0.33 "	24	45.5	41.5	37.5	FKP1R033307H	31	46	41.5	37.5	FKP1T033307I
0.47 "	31	46	41.5	37.5	FKP1R034707I	40	55	41.5	37.5	FKP1T034707K
0.68 "	40	55	41.5	37.5	FKP1R036807K	35	50	57	52.5	FKP1T036809F
1.0 µF	35	50	57	52.5	FKP1R041009F	45	55	57	52.5	FKP1T041009H
1.5 "	45	65	57	52.5	FKP1R041509J					

* AC voltages: $f \leq 1000 \text{ Hz}$; $1.4 \times U_{\text{rms}} + \text{UDC} \leq U_r$

** PCM = Printed circuit module = pin spacing

Dims. in mm.

Ionisation inception level in isolated cases may be lower than admissible rated AC voltage.

Part number completion:	
Version code:	2-pin = 00
	4-pin = D4
Tolerance:	20 % = M
	10 % = K
	5 % = J
Packing:	bulk = S
Pin length:	6-2 = SD
Taped version see page 157.	

Rights reserved to amend design data without prior notification

Continuation page 85

Continuation

General Data

Capacitance	2000 VDC/700 VAC*					4000 VDC/700 VAC*				
	W	H	L	PCM**	Part number	W	H	L	PCM**	Part number
100 pF	5	11	18	15	FKP1U001004B					
150 "	5	11	18	15	FKP1U001504B					
220 "	5	11	18	15	FKP1U002204B					
330 "	6	12.5	18	15	FKP1U003304C					
470 "	6	12.5	18	15	FKP1U004704C	5	14	26.5	22.5	FKP1X004705A
680 "	6	12.5	18	15	FKP1U006804C	5	14	26.5	22.5	FKP1X006805A
1000 pF	7	14	18	15	FKP1U011004D	5	14	26.5	22.5	FKP1X011005A
	5	14	26.5	22.5	FKP1U011005A					
1500 "	6	15	26.5	22.5	FKP1U011505B	7	16.5	26.5	22.5	FKP1X011505D
2200 "	7	16.5	26.5	22.5	FKP1U012205D	8.5	18.5	26.5	22.5	FKP1X012205F
3300 "	7	16.5	26.5	22.5	FKP1U013305D	10.5	20.5	26.5	22.5	FKP1X013305H
4700 "	8.5	18.5	26.5	22.5	FKP1U014705F	11	21	31.5	27.5	FKP1X014706B
6800 "	10.5	20.5	26.5	22.5	FKP1U016805H	13	24	31.5	27.5	FKP1X016806D
0.01 µF	11	21	31.5	27.5	FKP1U021006B	15	26	31.5	27.5	FKP1X021006F
0.015 "	13	24	31.5	27.5	FKP1U021506D	13	24	41.5	37.5	FKP1X021507C
0.022 "	15	26	31.5	27.5	FKP1U022206F	17	29	41.5	37.5	FKP1X022207E
	13	24	41.5	37.5	FKP1U022207C					
0.033 "	13	24	41.5	37.5	FKP1U023307C	20	39.5	41.5	37.5	FKP1X023307G
0.047 "	17	29	41.5	37.5	FKP1U024707E	24	45.5	41.5	37.5	FKP1X024707H
0.068 "	19	32	41.5	37.5	FKP1U026807F	31	46	41.5	37.5	FKP1X026807I
0.1 µF	20	39.5	41.5	37.5	FKP1U031007G	35	50	41.5	37.5	FKP1X031007J
0.15 "	24	45.5	41.5	37.5	FKP1U031507H	40	55	41.5	37.5	FKP1X031507K
0.22 "	35	50	41.5	37.5	FKP1U032207J	45	55	57	52.5	FKP1X032209H
0.33 "	40	55	41.5	37.5	FKP1U033307K					
0.47 "	45	55	57	52.5	FKP1U034709H					
0.68 "	45	65	57	52.5	FKP1U036809J					

* AC voltages: $f \leq 1000 \text{ Hz}$; $1.4 \times U_{\text{rms}} + U_{\text{DC}} \leq U_r$

** PCM = Printed circuit module = pin spacing

Dims. in mm.

Ionisation inception level in isolated cases may be lower than admissible rated AC voltage.

Part number completion:

Version code:	2-pin	= 00
	4-pin	= D4
Tolerance:	20 %	= M
	10 %	= K
	5 %	= J
Packing:	bulk	= S
Pin length:	6-2	= SD
Taped version see page 157.		

2-pin version

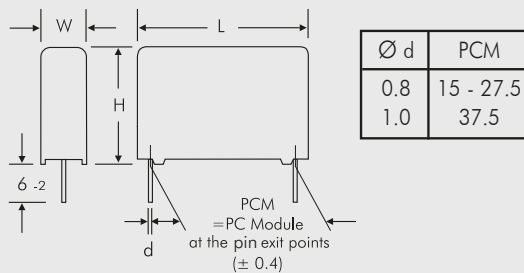

4-pin version

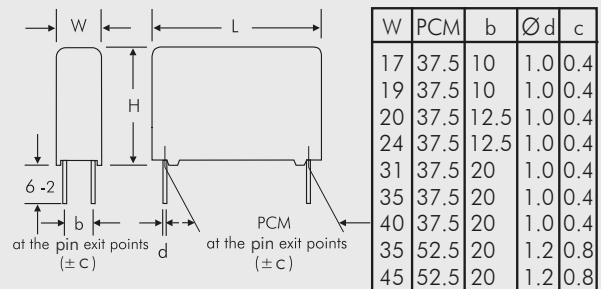

Rights reserved to amend design data without prior notification.

Continuation page 86

Continuation

General Data

Capacitance	6000 VDC/700 VAC*					Part number	Dims. in mm.																	
	W	H	L	PCM**																				
470 pF	5	14	26.5	22.5	FKP1Y004705A	Ionisation inception level in isolated cases may be lower than admissible rated AC voltage.																		
680 "	5	14	26.5	22.5	FKP1Y006805A																			
1000 pF	5	14	26.5	22.5	FKP1Y011005A																			
1500 "	7	16.5	26.5	22.5	FKP1Y011505D																			
2200 "	10.5	20.5	26.5	22.5	FKP1Y012205H																			
3300 "	10.5	20.5	26.5	22.5	FKP1Y013305H																			
4700 "	11	21	31.5	27.5	FKP1Y014706B																			
6800 "	13	24	31.5	27.5	FKP1Y016806D																			
0.01 μF	15	26	31.5	27.5	FKP1Y021006F	<table border="1"> <thead> <tr> <th colspan="2">Part number completion:</th> </tr> </thead> <tbody> <tr> <td>Version code:</td> <td>2-pin = 00</td> </tr> <tr> <td></td> <td>4-pin = D4</td> </tr> <tr> <td>Tolerance:</td> <td>20 % = M</td> </tr> <tr> <td></td> <td>10 % = K</td> </tr> <tr> <td></td> <td>5 % = J</td> </tr> <tr> <td>Packing:</td> <td>bulk = S</td> </tr> <tr> <td>Pin length:</td> <td>6-2 = SD</td> </tr> <tr> <td colspan="2">Taped version see page 157.</td> </tr> </tbody> </table>	Part number completion:		Version code:	2-pin = 00		4-pin = D4	Tolerance:	20 % = M		10 % = K		5 % = J	Packing:	bulk = S	Pin length:	6-2 = SD	Taped version see page 157.	
Part number completion:																								
Version code:	2-pin = 00																							
	4-pin = D4																							
Tolerance:	20 % = M																							
	10 % = K																							
	5 % = J																							
Packing:	bulk = S																							
Pin length:	6-2 = SD																							
Taped version see page 157.																								
0.015 "	13	24	41.5	37.5	FKP1Y021507C																			
0.022 "	17	29	41.5	37.5	FKP1Y022207E																			
0.033 "	20	39.5	41.5	37.5	FKP1Y023307G																			
0.047 "	24	45.5	41.5	37.5	FKP1Y024707H																			
0.068 "	31	46	41.5	37.5	FKP1Y026807I																			
0.1 μF	35	50	41.5	37.5	FKP1Y031007J																			
0.15 "	40	55	41.5	37.5	FKP1Y031507K																			
0.22 "	45	55	57	52.5	FKP1Y032209H																			

* AC voltages: $f \leq 1000 \text{ Hz}$; $1.4 \times U_{\text{rms}} + U_{\text{DC}} \leq U_r$

** PCM = Printed circuit module = pin spacing

Rights reserved to amend design data without prior notification.

Impedance change with frequency
(general guide).

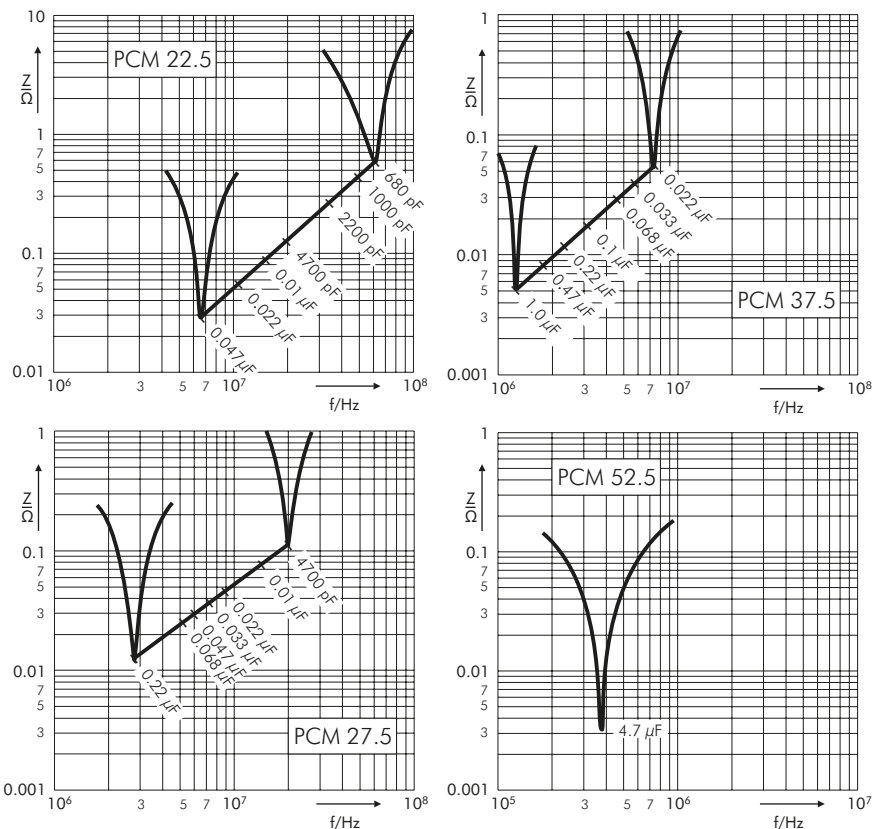

Continuation

Permissible AC voltage in relation to frequency till 15° C internal temperature rise (general guide).

The information behind the cross bar denote the PCM of the measured value.

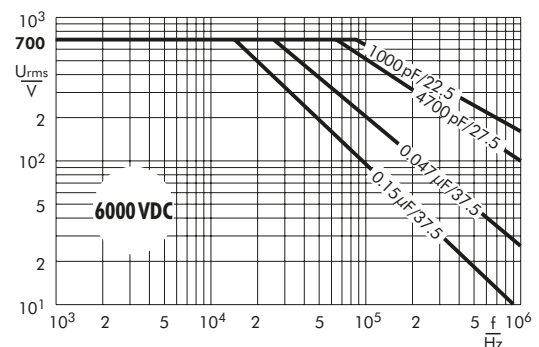
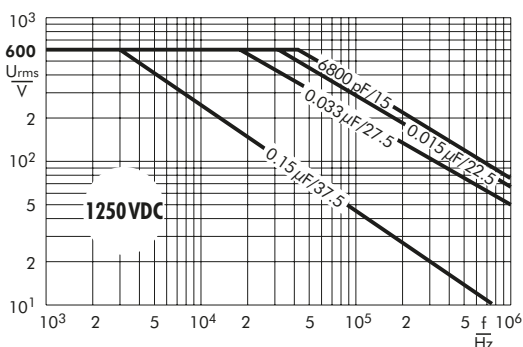
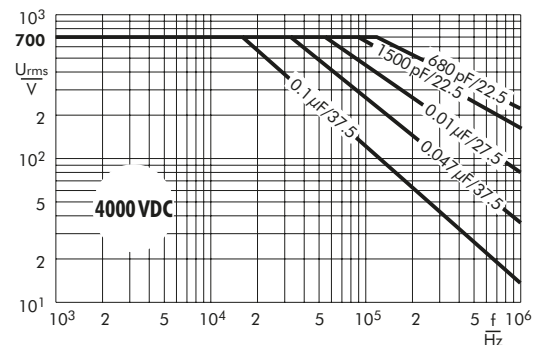
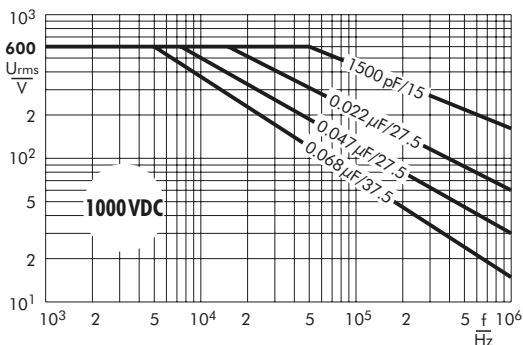
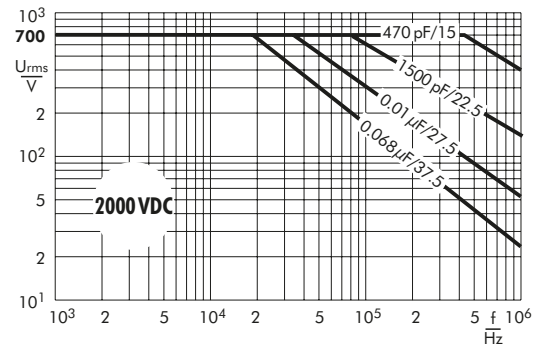
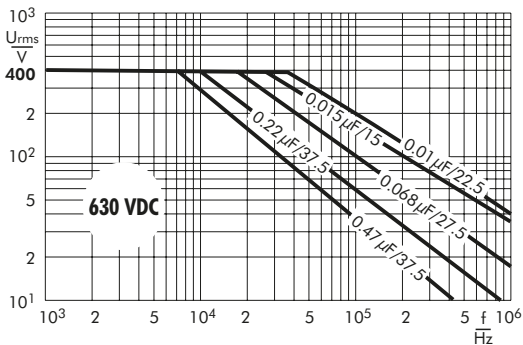
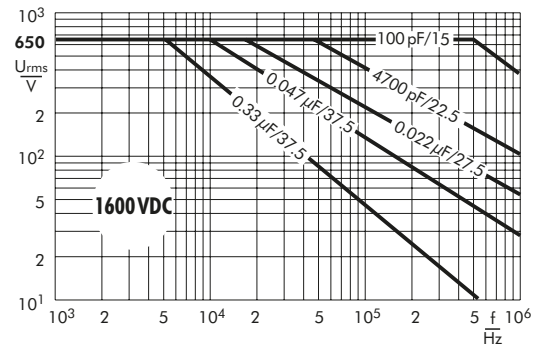
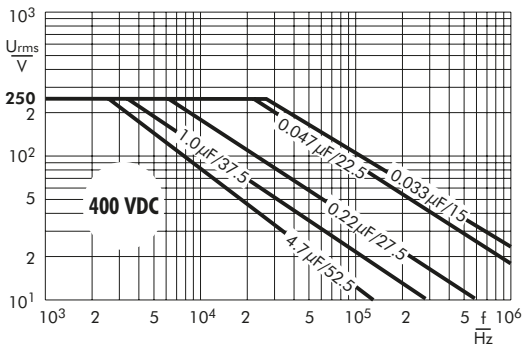

Continuation

Permissible AC current in relation to frequency till 15° C internal temperature rise (general guide).

The information behind the cross bar denote the PCM of the measured value.

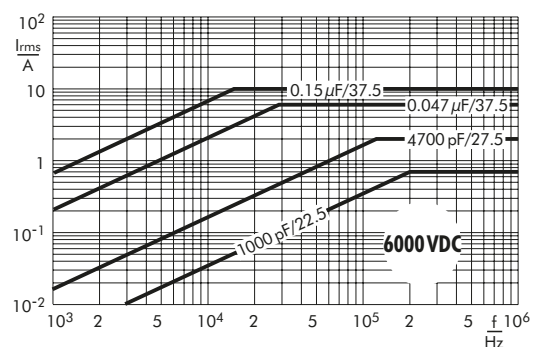
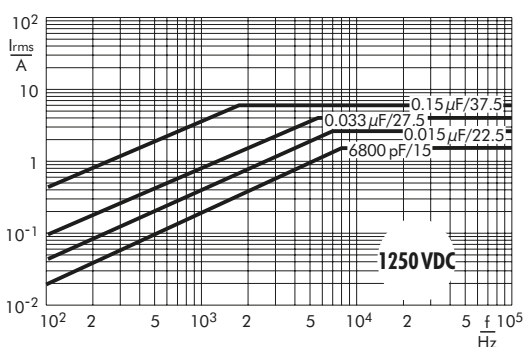
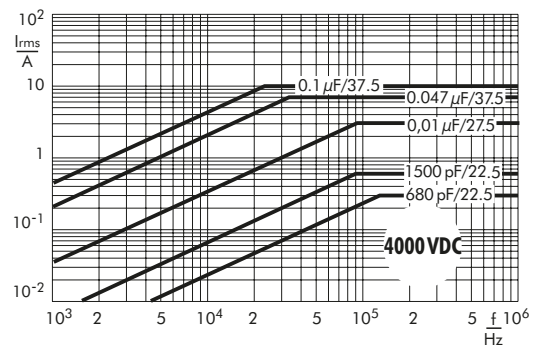
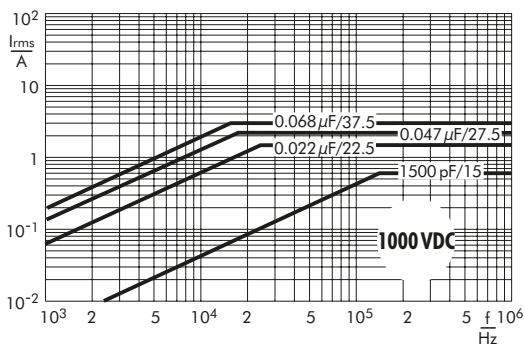
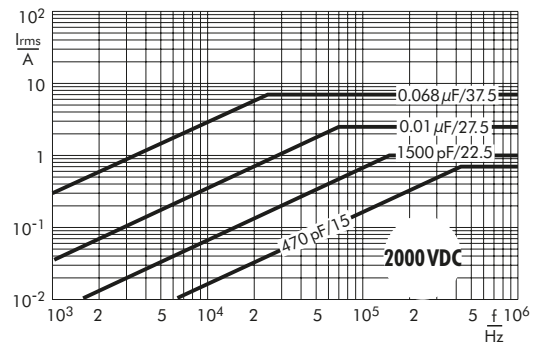
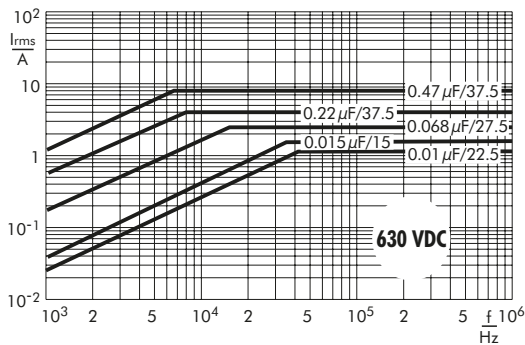
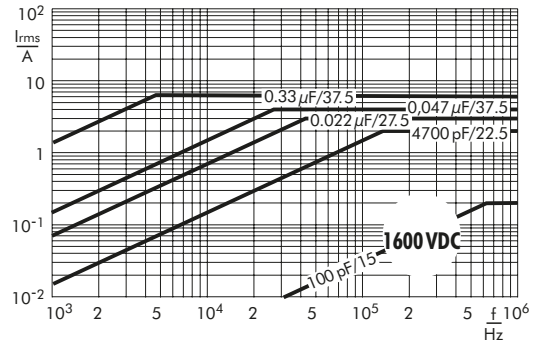
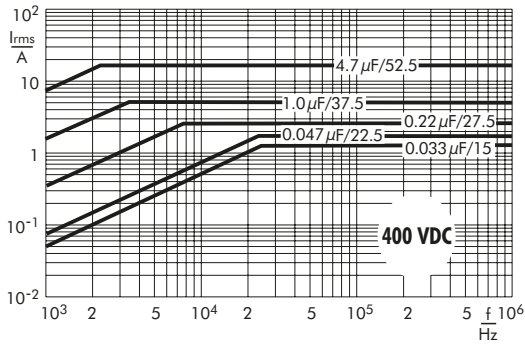

WIMA Radio Interference Suppression Capacitors for Overvoltage Protection



WIMA MKP-X2

WIMA MKP-Y2

WIMA MKP-X1 R

Depending on the application, radio interference suppression capacitors remain on the mains for an uninterrupted period of 10, 20 or more years. They need not only satisfy EMC requirements in suppressing outgoing interference from an application but they also have to protect the application from incoming power surges. Hence careful selection of these components is essential.

The special feature of WIMA Polypropylene RFI capacitors are the high capacitance values at smaller case sizes, being available with capacitances from 1000 pF through 10 μF at AC voltages of 300 VAC, 305 VAC and 440 VAC for class X2, X1 and Y2.

Based on the dielectric used they are highly cost-effective. The low attenuation construction results in a high degree of interference suppression with low ESR.

WIMA metallized RFI film capacitors exhibit a safe regeneration behaviour and reliably heal in case of a breakdown (self-healing).

Class X capacitors are connected between phase and neutral or phase and phase conductors. Class Y capacitors have an increased degree of electrical and mechanical safety and are connected, for example, between phase conductors and earthed casing, and thus by-pass operating insulation.

WIMARFI capacitors are approved according to IEC 60384-14/4, UL 60384-14 respective CAN/CSA-E60384-14 and CQC11-471115-2016.

The specified rated AC voltage takes into account a rise of the mains voltage of up to 10% above the nominal value, in accordance with IEC 60384-14.

The components are environmentally compatible with the RoHS 2015/863/EU regulations of the European Union.



Metallized Polypropylene (PP) RFI-Capacitors Class X2 in PCM 7.5 mm to 37.5 mm. Capacitances from 1000 pF to 10 µF. Rated Voltage 305 VAC.

Special Features

- Reliable self-healing
- High degree of interference suppression due to good attenuation and low ESR
- AEC-Q200 qualified
- According to RoHS 2015/863/EU

Typical Applications

Class X2 RFI applications to meet EMC regulations

- Capacitors connected to the mains between phase and neutral or phase conductors
- General requirements, pulse peak voltage ≤ 2.5 kV

Construction

Dielectric:

Polypropylene (PP) film

Capacitor electrodes:

Vacuum-deposited

Internal construction:

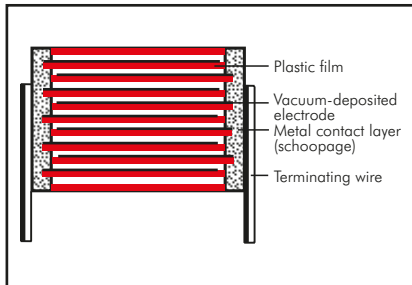

Encapsulation:

Solvent-resistant, flame-retardant plastic case with epoxy resin seal, UL 94 V-0

Terminations:

Tinned wire.

Marking:

Colour: Red. Marking: Black.

Electrical Data

Capacitance range: 1000 pF to 10 µF

Rated voltage: 305 VAC

Continuous DC voltage* (general guide): ≤ 560 V

Capacitance tolerances:

$\pm 20\%$, $\pm 10\%$, $\pm 5\%$

Operating temperature range:

-55°C to $+105^\circ\text{C}$

Climatic test category:

55/105/56 in accordance with IEC

Passive flammability class:

B for capacitors with $V > 1750$ mm³

C for capacitors with $V \leq 1750$ mm³

Test specifications:

In accordance with IEC 60384-14

Dissipation factors at $+20^\circ\text{C}$: $\tan \delta$

at f	$C \leq 0.1 \mu\text{F}$	$0.1 \mu\text{F} < C \leq 1.0 \mu\text{F}$	$C > 1.0 \mu\text{F}$
1 kHz	$\leq 18 \times 10^{-4}$	$\leq 20 \times 10^{-4}$	$\leq 20 \times 10^{-4}$
10 kHz	$\leq 20 \times 10^{-4}$	$\leq 60 \times 10^{-4}$	–
100 kHz	$\leq 50 \times 10^{-4}$	–	–

Approvals:

Country	Authority	Specification	Symbol	Approval-No.
Germany	VDE	IEC 60384-14/4		40003472
USA/Canada	UL	UL 60384-14 CAN/CSA-E60384-14		E 134915
China	CQC	CQC11-471115-2016		CQC20001271097

Mechanical Tests

Pull test on pins: 10 N in direction of pins according to IEC 60068-2-21

Vibration: 6 hours at 10 ... 2000 Hz and 0.75 mm displacement amplitude or 10 g in accordance with IEC 60068-2-6

Low air density: 1 kPa = 10 mbar in accordance with IEC 60068-2-13

Bump test: 4000 bumps at 390 m/sec² in accordance with IEC 60068-2-29

* If safety-approved EMI suppression capacitors are operated with a DC voltage being above the specified AC voltage rating the given approvals are no longer valid (IEC 60384-14).

Furthermore the permissible pulse rise time du/dt (F_{max}) will be subject to a reduction according to

$$F_{\text{max}} = F_r \times \sqrt{2} \times \text{UAC} / \text{UDC}$$

if the DC operating voltage UDC is higher than $\sqrt{2} \times \text{UAC}$

Insulation resistance at $+20^\circ\text{C}$:

$C \leq 0.33 \mu\text{F}$: $\geq 1.5 \times 10^4$ MΩ

$C > 0.33 \mu\text{F}$: ≥ 5000 sec (MΩ x µF)

Measuring voltage: 100 V/1 min.

Maximum pulse rise time:

100 V/µsec for pulses equal to a voltage amplitude with $\sqrt{2} \times 305$ VAC = 432 V according to IEC 60384-14

Test voltage:

$C \leq 1.0 \mu\text{F}$: 2260 VDC, 2 sec.

$C > 1.0 \mu\text{F}$: 1800 VDC, 2 sec.

Reliability:

Operational life > 300000 hours

Failure rate < 2 fit ($0.5 \times U_r$ and 40°C)

Packing

Available taped and reeled up to and including case size 15 x 26 x 31.5 / PCM 27.5 mm.

Detailed taping information and graphs at the end of the catalogue.

For further details and graphs please refer to Technical Information.

Continuation

General Data

Capacitance	305 VAC*					Part number
	W	H	L	PCM**		
1000 pF	4	9	10	7.5	MKX2AW11002C00	
1200 "	4	9	10	7.5	MKX2AW11202C00	
1500 "	4	9	10	7.5	MKX2AW11502C00	
1800 "	4	9	10	7.5	MKX2AW11802C00	
2200 "	4	9	10	7.5	MKX2AW12202C00	
2700 "	4	9	10	7.5	MKX2AW12702C00	
3300 "	4	9	10	7.5	MKX2AW13302C00	
3900 "	4	9	10	7.5	MKX2AW13902C00	
4700 "	4	9	10	7.5	MKX2AW14702C00	
5600 "	4	9	10	7.5	MKX2AW15602C00	
6800 "	4	9	10	7.5	MKX2AW16802C00	
8200 "	4	9	10	7.5	MKX2AW18202C00	
0.01 µF	4	9	10	7.5	MKX2AW21002C00	
	5	11	13	10	MKX2AW21003F00	
0.012 "	4	9	10	7.5	MKX2AW21202C00	
	5	11	13	10	MKX2AW21203F00	
0.015 "	4	9	10	7.5	MKX2AW21502C00	
	5	11	13	10	MKX2AW21503F00	
0.018 "	4	9	10	7.5	MKX2AW21802C00	
	5	11	13	10	MKX2AW21803F00	
0.022 "	4	9	10	7.5	MKX2AW22202C00	
	5	11	13	10	MKX2AW22203F00	
0.027 "	5	10.5	10.3	7.5	MKX2AW22702E00	
	5	11	13	10	MKX2AW22703F00	
0.033 "	5	10.5	10.3	7.5	MKX2AW23302E00	
	5	11	13	10	MKX2AW23303F00	
0.039 "	5.7	12.5	10.3	7.5	MKX2AW23902F00	
	5	11	13	10	MKX2AW23903F00	
0.047 "	5.7	12.5	10.3	7.5	MKX2AW24702F00	
	6	12.5	13	10	MKX2AW24703H00	
	5	11	18	15	MKX2AW24704B00	
0.056 "	6	12.5	13	10	MKX2AW25603H00	
	5	11	18	15	MKX2AW25604B00	
0.068 "	6	12.5	13	10	MKX2AW26803H00	
	5	11	18	15	MKX2AW26804B00	
0.082 "	6	12.5	13	10	MKX2AW28203H00	
	5	11	18	15	MKX2AW28204B00	

* f = 50/60 Hz

** PCM = Printed circuit module = pin spacing

Dims. in mm.

d = 0.6 Ø if PCM < 15
d = 0.8 Ø if PCM ≥ 15

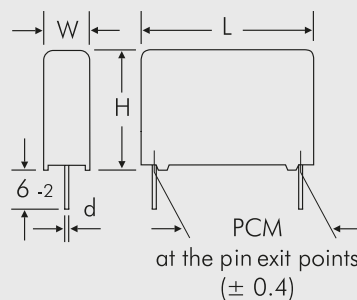

Part number completion:	
Tolerance:	20 % = M
	10 % = K
	5 % = J
Packing:	bulk = S
Pin length:	6-2 = SD
Taped version see page 157.	

Rights reserved to amend design data without prior notification.

Continuation

General Data

Capacitance	305 VAC*				PCM**	Part number
	W	H	L			
0.1 μ F	8	12	13		10	MKX2AW31003I00_____
	5	11	18		15	MKX2AW31004B00_____
	6	12.5	18		15	MKX2AW31004C00_____
0.12 "	6	12.5	18		15	MKX2AW31204C00_____
	6	12.5	18		15	MKX2AW31504C00_____
0.15 "	8	15	18		15	MKX2AW31504F00_____
	6	15	26.5		22.5	MKX2AW31505B00_____
	8	15	18		15	MKX2AW31804F00_____
0.18 "	6	15	26.5		22.5	MKX2AW31805B00_____
	9	14	18		15	MKX2AW32204H00_____
0.22 "	8	15	18		15	MKX2AW32204F00_____
	6	15	26.5		22.5	MKX2AW32205B00_____
	8	15	18		15	MKX2AW32704F00_____
0.27 "	7	16.5	26.5		22.5	MKX2AW32705D00_____
	11	14	18		15	MKX2AW33304M00_____
0.33 "	9	16	18		15	MKX2AW33304J00_____
	7	16.5	26.5		22.5	MKX2AW33305D00_____
	8.5	18.5	26.5		22.5	MKX2AW33905F00_____
0.39 "	8.5	18.5	26.5		22.5	MKX2AW34705F00_____
	10.5	19	26.5		22.5	MKX2AW34705G00_____
0.47 "	9	19	31.5		27.5	MKX2AW34706A00_____
	10.5	19	26.5		22.5	MKX2AW35605G00_____
0.56 "	9	19	31.5		27.5	MKX2AW35606A00_____
	10.5	19	26.5		22.5	MKX2AW36805G00_____
0.68 "	11	21	26.5		22.5	MKX2AW36805I00_____
	9	19	31.5		27.5	MKX2AW36806A00_____
	11	21	26.5		22.5	MKX2AW38205I00_____
0.82 "	9	19	31.5		27.5	MKX2AW38206A00_____

* f = 50/60 Hz

** PCM = Printed circuit module = pin spacing

Dims. in mm.

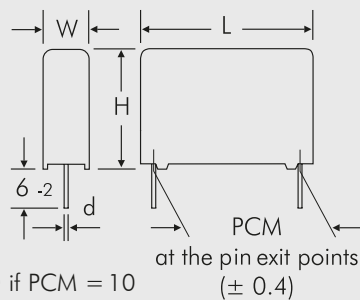

d = 0.6 \varnothing if PCM = 10
d = 0.8 \varnothing if PCM \geq 15

Part number completion:
Tolerance: 20 % = M
10 % = K
5 % = J
Packing: bulk = S
Pin length: 6-2 = SD
Taped version see page 157.

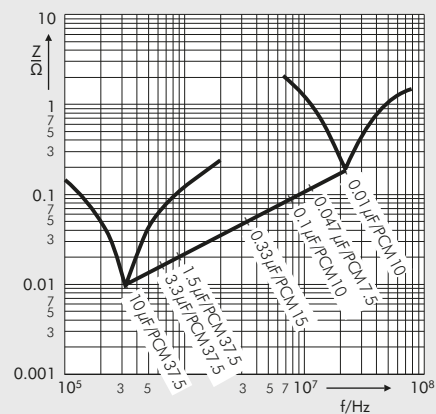

Impedance change with frequency
(general guide).

Rights reserved to amend design data without prior notification.

Continuation page 93

Continuation

General Data

Capacitance	305 VAC*				Part number
	W	H	L	PCM**	
1.0 μ F	11	21	26.5	22.5	MKX2AW41005I00_____
	11	21	31.5	27.5	MKX2AW41006B00_____
	13	24	31.5	27.5	MKX2AW41006D00_____
1.2 "	11	21	31.5	27.5	MKX2AW41206B00_____
1.5 "	13	24	31.5	27.5	MKX2AW41506D00_____
	15	26	31.5	27.5	MKX2AW41506F00_____
	13	24	41.5	37.5	MKX2AW41507C00_____
1.8 "	13	24	31.5	27.5	MKX2AW41806D00_____
	13	24	41.5	37.5	MKX2AW41807C00_____
	15	26	31.5	27.5	MKX2AW42206F00_____
2.2 "	17	29	31.5	27.5	MKX2AW42206G00_____
	13	24	41.5	37.5	MKX2AW42207C00_____
	15	26	41.5	37.5	MKX2AW42207D00_____
2.7 "	17	29	31.5	27.5	MKX2AW42706G00_____
	15	26	41.5	37.5	MKX2AW42707D00_____
	17	29	41.5	37.5	MKX2AW42707E00_____
3.3 "	17	34.5	31.5	27.5	MKX2AW43306I00_____
	20	39.5	31.5	27.5	MKX2AW43306J00_____
	15	26	41.5	37.5	MKX2AW43307D00_____
3.9 "	17	29	41.5	37.5	MKX2AW43307E00_____
	17	34.5	31.5	27.5	MKX2AW43906I00_____
	17	29	41.5	37.5	MKX2AW43907E00_____
4.7 "	19	32	41.5	37.5	MKX2AW43907F00_____
	20	39.5	31.5	27.5	MKX2AW44706J00_____
	19	32	41.5	37.5	MKX2AW44707F00_____
5.6 "	20	39.5	41.5	37.5	MKX2AW44707G00_____
	19	32	41.5	37.5	MKX2AW45607F00_____
	20	39.5	41.5	37.5	MKX2AW45607G00_____
6.8 "	20	39.5	41.5	37.5	MKX2AW46807G00_____
	24	45.5	41.5	37.5	MKX2AW46807H00_____
8.2 "	24	45.5	41.5	37.5	MKX2AW48207H00_____
	31	46	41.5	37.5	MKX2AW48207I00_____
10 μ F	24	45.5	41.5	37.5	MKX2AW51007H00_____
	31	46	41.5	37.5	MKX2AW51007I00_____

* f = 50/60 Hz

** PCM = Printed circuit module = pin spacing

Dims. in mm.

d = 0.8 \varnothing if PCM \leq 27.5
d = 1.0 \varnothing if PCM = 37.5

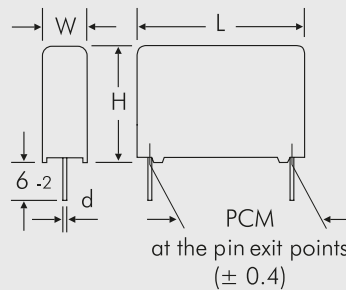

Part number completion:

Tolerance: 20 % = M
10 % = K
5 % = J

Packing: bulk = S
Pin length: 6-2 = SD

Taped version see page 157.

Rights reserved to amend design data without prior notification.

Continuation page 94

WIMA MKP-X2



Continuation

Permissible AC current in relation to frequency at 10° C internal temperature rise (general guide).

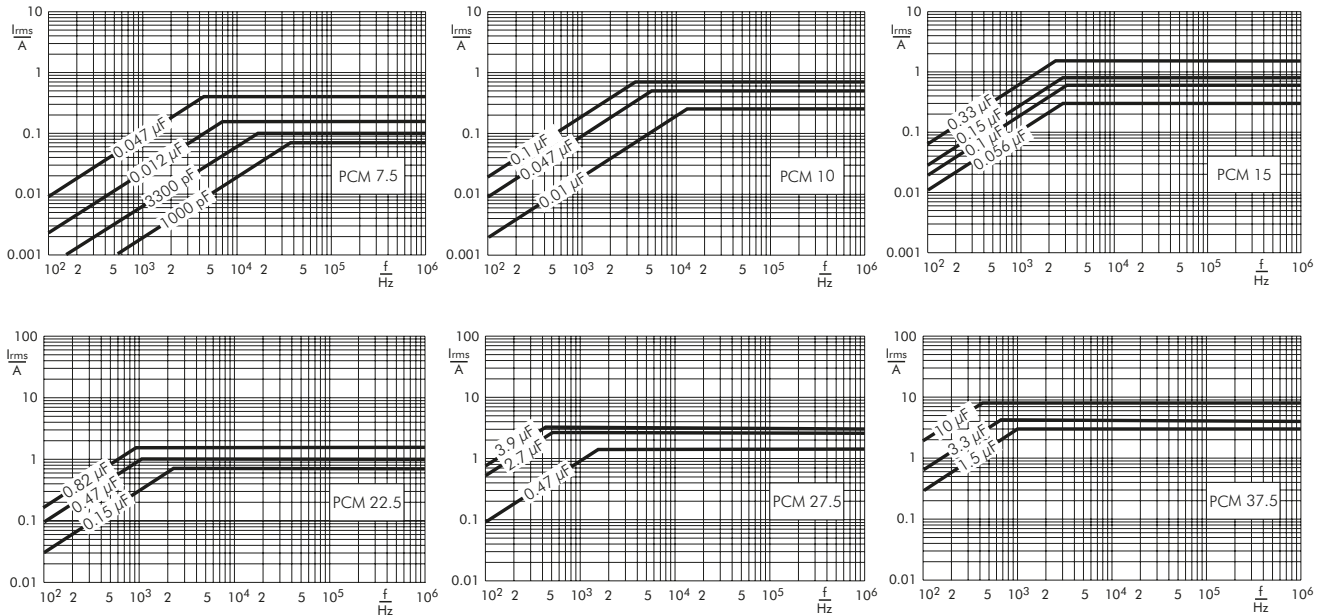

WIMA MKP-Y2

Permissible AC current in relation to frequency at 10° C internal temperature rise (general guide).

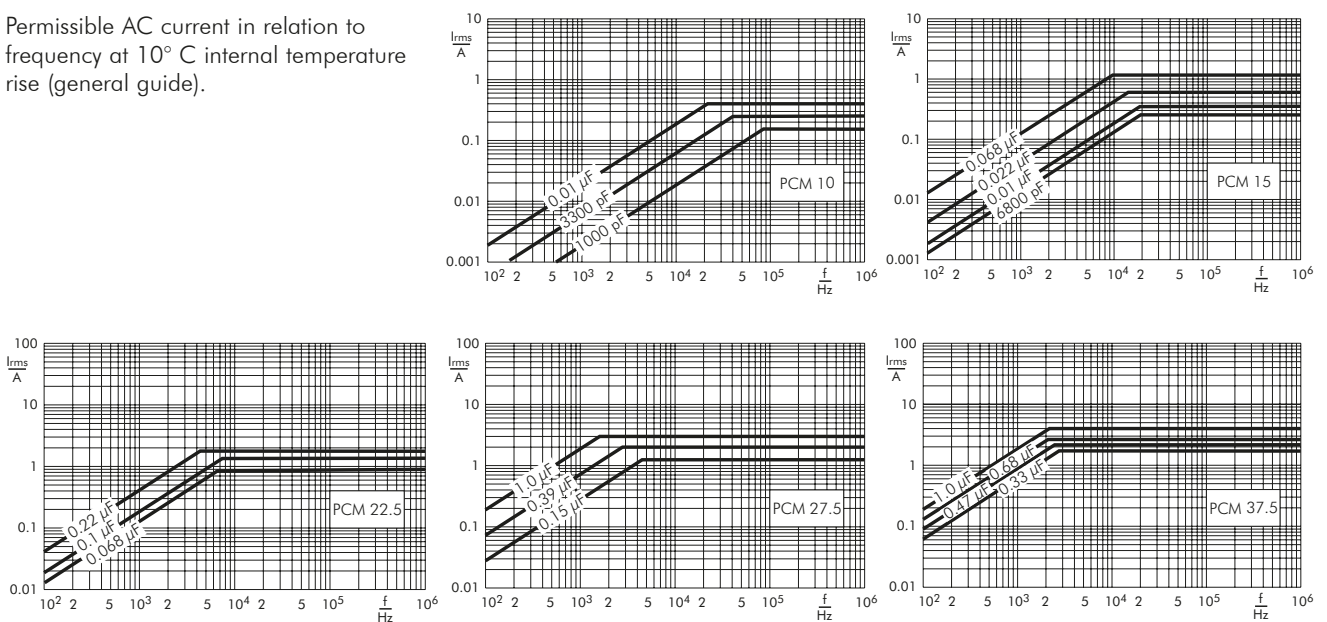

Technical information and general data see page 95

**Metallized Polypropylene (PP) RFI-Capacitors Class Y2
in PCM 10 mm to 37.5 mm. Capacitances from 1000 pF to 1.0 μF.
Rated Voltage 300 VAC.**

Special Features

- Reliable self-healing
- High degree of interference suppression due to good attenuation and low ESR
- AEC-Q200 qualified
- According to RoHS 2015/863/EU

Typical Applications

Class Y2 RFI applications to meet EMC regulations

- Capacitors connected to the mains between phase or neutral and earthed casing
- By-passing of the basic or supplementary insulation, pulse peak voltage ≤ 5 kV

Construction

Dielectric:

Polypropylene (PP) film

Capacitor electrodes:

Vacuum-deposited

Internal construction:

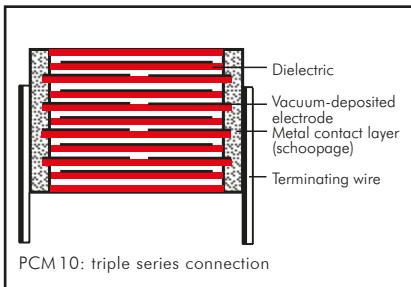

Encapsulation:

Solvent-resistant, flame-retardant plastic case with epoxy resin seal, UL 94 V-0

Terminations:

Tinned wire.

Marking:

Colour: Red. Marking: Black.

Electrical Data

Capacitance range: 1000 pF to 1.0 μF

Rated voltage: 300 VAC

Continuous DC voltage* (general guide): ≤ 1000 V

Capacitance tolerances:

±20%, ±10%, ±5%

Operating temperature range:

−55° C to +105° C

Climatic test category:

55/105/56 in accordance with IEC

Passive flammability class:

B for capacitors with V > 1750 mm³

C for capacitors with V ≤ 1750 mm³

Dissipation factors at + 20° C: tan δ

at f	C ≤ 0.1 μF	0.1 μF < C ≤ 1.0 μF
1 kHz	≤ 18 x 10 ⁻⁴	≤ 20 x 10 ⁻⁴
10 kHz	≤ 20 x 10 ⁻⁴	≤ 60 x 10 ⁻⁴
100 kHz	≤ 100 x 10 ⁻⁴	–

Insulation resistance at +20° C:

C ≤ 0.33 μF: ≥ 1.5 x 10⁴ MΩ

C > 0.33 μF: ≥ 5 000 sec (MΩ x μF)

Measuring voltage: 100 V/1 min.

Test specifications:

In accordance with IEC 60384-14

Maximum pulse rise time:

100 V/μsec for pulses equal to a voltage

amplitude with √2 x 300 VAC = 425 V

according to IEC 60384-14

Test voltage: 2700 VDC, 2 sec.

Reliability:

Operational life > 300 000 hours

Failure rate < 2 fit (0.5 x U_r and 40° C)

Approvals:

Country	Authority	Specification	Symbol	Approval-No.
Germany	VDE	IEC 60384-14/4		40008997
USA/Canada	UL	UL 60384-14 CAN/CSA-E60384-14		E 134915

Mechanical Tests

Pull test on pins: 10 N in direction of pins according to IEC 60068-2-21

Vibration: 6 hours at 10...2000 Hz and 0.75 mm displacement amplitude or 10 g in accordance with IEC 60068-2-6

Low air density: 1 kPa = 10 mbar in accordance with IEC 60068-2-13

Bump test: 4000 bumps at 390 m/sec² in accordance with IEC 60068-2-29

Packing

Available taped and reeled.

Detailed taping information and graphs at the end of the catalogue.

* If safety-approved EMI suppression capacitors are operated with a DC voltage being above the specified AC voltage rating the given approvals are no longer valid (IEC 60384-14).

Furthermore the permissible pulse rise time du/dt (F_{max.}) will be subject to a reduction according to

$$F_{max.} = F_r \times \sqrt{2} \times UAC / UDC$$

if the DC operating voltage UDC is higher than √2 x UAC

For further details and graphs please refer to Technical Information.

Continuation

General Data

Capacitance	300 VAC*				PCM**	Part number
	W	H	L			
1000 pF	4	9.5	13		10	MKY22W11003D00
1200 "	4	9.5	13		10	MKY22W11203D00
1500 "	4	9.5	13		10	MKY22W11503D00
1800 "	4	9.5	13		10	MKY22W11803D00
2200 "	4	9.5	13		10	MKY22W12203D00
2700 "	4	9.5	13		10	MKY22W12703D00
3300 "	4	9.5	13		10	MKY22W13303D00
3900 "	4	9.5	13		10	MKY22W13903D00
4700 "	5	11	13		10	MKY22W14703F00
5600 "	5	11	13		10	MKY22W15603F00
6800 "	6	12.5	13		10	MKY22W16803H00
	5	11	18		15	MKY22W16804B00
8200 "	6	12.5	13		10	MKY22W18203H00
	5	11	18		15	MKY22W18204B00
0.01 µF	8	12	13		10	MKY22W21003I00
	5	11	18		15	MKY22W21004B00
0.012 "	5	11	18		15	MKY22W21204B00
0.015 "	5	11	18		15	MKY22W21504B00
0.018 "	5	11	18		15	MKY22W21804B00
0.022 "	6	12.5	18		15	MKY22W22204C00
0.027 "	6	12.5	18		15	MKY22W22704C00
0.033 "	8	15	18		15	MKY22W23304F00
0.039 "	8	15	18		15	MKY22W23904F00
0.047 "	8	15	18		15	MKY22W24704F00
0.056 "	8	15	18		15	MKY22W25604F00
0.068 "	9	16	18		15	MKY22W26804J00
	6	15	26.5		22.5	MKY22W26805B00
0.082 "	7	16.5	26.5		22.5	MKY22W28205D00

* f = 50/60 Hz

** PCM = Printed circuit module = pin spacing

Dims. in mm.

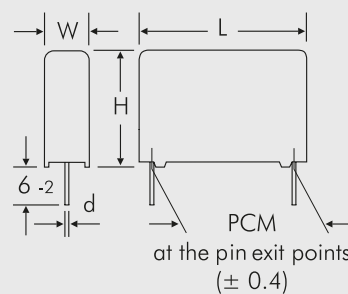

d = 0.6 Ø if PCM = 10
d = 0.8 Ø if PCM = 15 - 22.5

Part number completion:	
Tolerance:	20 % = M
	10 % = K
	5 % = J
Packing:	bulk = S
Pin length:	6-2 = SD
Taped version see page 157.	

Rights reserved to amend design data without prior notification.

Continuation page 97

Continuation

General Data

Capacitance	300 VAC*			PCM**	Part number
	W	H	L		
0.1 μ F	7	16.5	26.5	22.5	MKY22W31005D00
0.12 "	8.5	18.5	26.5	22.5	MKY22W31205F00
0.15 "	8.5	18.5	26.5	22.5	MKY22W31505F00
	9	19	31.5	27.5	MKY22W31506A00
0.18 "	10.5	19	26.5	22.5	MKY22W31805G00
	9	19	31.5	27.5	MKY22W31806A00
0.22 "	11	21	26.5	22.5	MKY22W32205I00
	9	19	31.5	27.5	MKY22W32206A00
0.27 "	11	21	31.5	27.5	MKY22W32706B00
0.33 "	11	21	31.5	27.5	MKY22W33306B00
	13	24	41.5	37.5	MKY22W33307C00
0.39 "	13	24	31.5	27.5	MKY22W33906D00
	13	24	41.5	37.5	MKY22W33907C00
0.47 "	15	26	31.5	27.5	MKY22W34706F00
	13	24	41.5	37.5	MKY22W34707C00
0.56 "	15	26	31.5	27.5	MKY22W35606F00
	13	24	41.5	37.5	MKY22W35607C00
	15	26	41.5	37.5	MKY22W35607D00
0.68 "	17	29	31.5	27.5	MKY22W36806G00
	15	26	41.5	37.5	MKY22W36807D00
	17	29	41.5	37.5	MKY22W36807E00
0.82 "	17	34.5	31.5	27.5	MKY22W38206I00
	17	29	41.5	37.5	MKY22W38207E00
	19	32	41.5	37.5	MKY22W38207F00
1.0 μ F	20	39.5	31.5	27.5	MKY22W41006J00
	17	29	41.5	37.5	MKY22W41007E00
	20	39.5	41.5	37.5	MKY22W41007G00

* f = 50/60 Hz

** PCM = Printed circuit module = pin spacing

Dims. in mm.

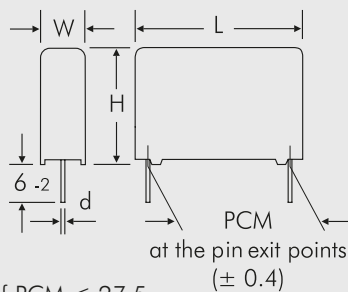

Part number completion:
 Tolerance: 20 % = M
 10 % = K
 5 % = J
 Packing: bulk = S
 Pin length: 6-2 = SD
 Taped version see page 157.

d = 0.8 \varnothing if PCM \leq 27.5
 d = 1.0 \varnothing if PCM = 37.5

Rights reserved to amend design data without prior notification.

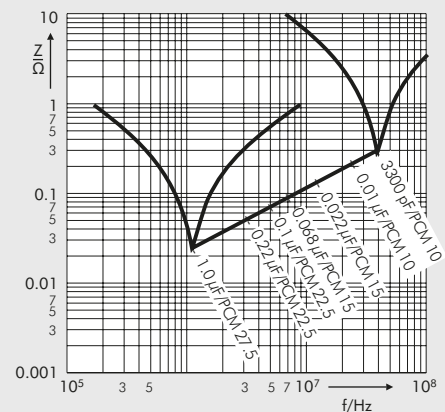

Impedance change with frequency (general guide).

AC current graphs see page 94

**Metallized Polypropylene (PP) RFI-Capacitors Class X1
with Internal Series Connection in PCM 10 mm to 37.5 mm.
Capacitances from 1000 pF to 2.2 µF. Rated Voltage 440 VAC.**

Special Features

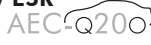
- Reliable self-healing
- Increased corona inception level due to internal series connection
- High degree of interference suppression due to good attenuation and low ESR
- AEC-Q200 qualified 
- According to RoHS 2015/863/EU

Typical Applications

Class X1 RFI applications to meet EMC regulations

- Capacitors connected to the mains between phase and neutral or phase and phase conductors
- High peak voltage applications, pulse peak voltage ≤ 4 kV

Construction

Dielectric:

Polypropylene (PP) film

Capacitor electrodes:

Vacuum-deposited

Internal construction:

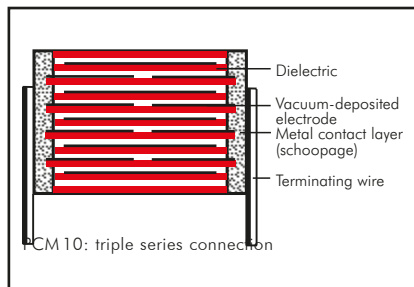

Encapsulation:

Solvent-resistant, flame-retardant plastic case with epoxy resin seal, UL 94 V-0

Terminations:

Tinned wire.

Marking:

Colour: Red. Marking: Black.

Electrical Data

Capacitance range: 1000 pF to 2.2 µF

Rated voltage: 440 VAC

Continuous DC voltage* (general guide): ≤ 1000 V

Capacitance tolerances:

$\pm 20\%$, $\pm 10\%$, $\pm 5\%$

Operating temperature range:

-55°C to $+105^\circ\text{C}$

Climatic test category:

55/105/56 in accordance with IEC

Passive flammability class:

B for capacitors with $V > 1750$ mm³

C for capacitors with $V \leq 1750$ mm³

Test specifications:

In accordance with IEC 60384-14

Dissipation factors at $+20^\circ\text{C}$: $\tan \delta$

at f	$C \leq 0.1 \mu\text{F}$	$0.1 \mu\text{F} < C \leq 1.0 \mu\text{F}$	$C > 1.0 \mu\text{F}$
1 kHz	$\leq 18 \times 10^{-4}$	$\leq 20 \times 10^{-4}$	$\leq 30 \times 10^{-4}$
10 kHz	$\leq 20 \times 10^{-4}$	$\leq 60 \times 10^{-4}$	–
100 kHz	$\leq 100 \times 10^{-4}$	–	–

Insulation resistance at $+20^\circ\text{C}$:

$C \leq 0.33 \mu\text{F}$: $\geq 1.5 \times 10^4$ MΩ

$C > 0.33 \mu\text{F}$: ≥ 5000 sec (MΩ x µF)

Measuring voltage: 100 V/1 min.

Maximum pulse rise time:

100 V/µsec for pulses equal to a voltage

amplitude with $\sqrt{2} \times 440$ VAC = 623 V

according to IEC 60384-14

Test voltage:

$C \leq 1.0 \mu\text{F}$: 2260 VDC, 2sec.



$C > 1.0 \mu\text{F}$: 1900 VDC, 2sec.

Reliability:

Operational life > 300000 hours

Failure rate < 2 fit ($0.5 \times U_r$ and 40°C)

Approvals:

Country	Authority	Specification	Symbol	Approval-No.
Germany	VDE	IEC 60384-14/4		40041297
USA/Canada	UL	UL 60384-14 CAN/CSA-E60384-14		E 134915

Mechanical Tests

Pull test on pins: 10 N in direction of pins according to IEC 60068-2-21

Vibration: 6 hours at 10...2000 Hz and 0.75 mm displacement amplitude or 10 g in accordance with IEC 60068-2-6

Low air density: 1 kPa = 10 mbar in accordance with IEC 60068-2-13

Bump test: 4000 bumps at 390 m/sec² in accordance with IEC 60068-2-29

* If safety-approved EMI suppression capacitors are operated with a DC voltage being above the specified AC voltage rating the given approvals are no longer valid (IEC 60384-14).

Furthermore the permissible pulse rise time du/dt ($F_{max.}$) will be subject to a reduction according to

$$F_{max.} = F_r \times \sqrt{2} \times UAC / UDC$$

if the DC operating voltage UDC is higher than $\sqrt{2} \times UAC$

Packing

Available taped and reeled up to and including case size 15 x 26 x 31.5 / PCM 27.5 mm.

Detailed taping information and graphs at the end of the catalogue.

For further details and graphs please refer to Technical Information.

Continuation

General Data

Capacitance	440 VAC*				PCM**	Part number
	W	H	L			
1000 pF	4	9.5	13		10	MKX14W11003D00
1200 „	4	9.5	13		10	MKX14W11203D00
1500 „	4	9.5	13		10	MKX14W11503D00
1800 „	4	9.5	13		10	MKX14W11803D00
2200 „	4	9.5	13		10	MKX14W12203D00
2700 „	4	9.5	13		10	MKX14W12703D00
3300 „	4	9.5	13		10	MKX14W13303D00
3900 „	4	9.5	13		10	MKX14W13903D00
4700 „	5	11	13		10	MKX14W14703F00
5600 „	5	11	13		10	MKX14W15603F00
6800 „	6	12.5	13		10	MKX14W16803H00
	5	11	18		15	MKX14W16804B00
8200 „	6	12.5	13		10	MKX14W18203H00
	5	11	18		15	MKX14W18204B00
0.01 µF	8	12	13		10	MKX14W21003I00
	5	11	18		15	MKX14W21004B00
0.012 „	5	11	18		15	MKX14W21204B00
0.015 „	5	11	18		15	MKX14W21504B00
0.018 „	5	11	18		15	MKX14W21804B00
0.022 „	6	12.5	18		15	MKX14W22204C00
0.027 „	6	12.5	18		15	MKX14W22704C00
0.033 „	8	15	18		15	MKX14W23304F00
0.039 „	8	15	18		15	MKX14W23904F00
0.047 „	8	15	18		15	MKX14W24704F00
0.056 „	8	15	18		15	MKX14W25604F00
0.068 „	9	16	18		15	MKX14W26804J00
	6	15	26.5		22.5	MKX14W26805B00
0.082 „	7	16.5	26.5		22.5	MKX14W28205D00

* f = 50/60 Hz

** PCM = Printed circuit module = pin spacing

Dims. in mm.

d = 0.6 Ø if PCM = 10
d = 0.8 Ø if PCM = 15 - 22.5

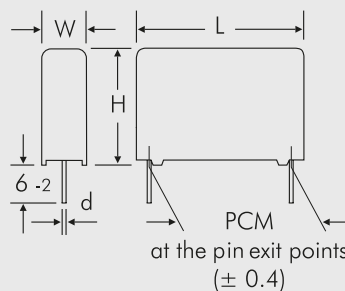

Part number completion:	
Tolerance:	20 % = M
	10 % = K
	5 % = J
Packing:	bulk = S
Pin length:	6-2 = SD
Taped version see page 157.	

Rights reserved to amend design data without prior notification.

Continuation page 100

Continuation

General Data

Capacitance	440 VAC*				PCM**	Part number
	W	H	L			
0.1 μF	6	15	26.5		22.5	MKX14W31005B00_____
	7	16.5	26.5		22.5	MKX14W31005D00_____
0.12 "	7	16.5	26.5		22.5	MKX14W31205D00_____
	8.5	18.5	26.5		22.5	MKX14W31205F00_____
0.15 "	7	16.5	26.5		22.5	MKX14W31505D00_____
	8.5	18.5	26.5		22.5	MKX14W31505F00_____
0.18 "	9	19	31.5		27.5	MKX14W31506A00_____
	8.5	18.5	26.5		22.5	MKX14W31805F00_____
	10.5	19	26.5		22.5	MKX14W31805G00_____
0.22 "	9	19	31.5		27.5	MKX14W31806A00_____
	8.5	18.5	26.5		22.5	MKX14W32205F00_____
	11	21	26.5		22.5	MKX14W32205I00_____
0.27 "	9	19	31.5		27.5	MKX14W32206A00_____
	10.5	19	26.5		22.5	MKX14W32705G00_____
	9	19	31.5		27.5	MKX14W32706A00_____
0.33 "	11	21	31.5		27.5	MKX14W32706B00_____
	11	21	26.5		22.5	MKX14W33305I00_____
	9	19	31.5		27.5	MKX14W33306A00_____
0.39 "	11	21	31.5		27.5	MKX14W33306B00_____
	13	24	41.5		37.5	MKX14W33307C00_____
	11	21	31.5		27.5	MKX14W33906B00_____
0.47 "	13	24	31.5		27.5	MKX14W33906D00_____
	13	24	41.5		37.5	MKX14W33907C00_____
	11	21	31.5		27.5	MKX14W34706B00_____
0.56 "	15	26	31.5		27.5	MKX14W34706F00_____
	13	24	41.5		37.5	MKX14W34707C00_____
	13	24	31.5		27.5	MKX14W35606D00_____
0.68 "	15	26	31.5		27.5	MKX14W35606F00_____
	13	24	41.5		37.5	MKX14W35607C00_____
	15	26	41.5		37.5	MKX14W35607D00_____
0.82 "	15	26	31.5		27.5	MKX14W36806F00_____
	17	29	31.5		27.5	MKX14W36806G00_____
	13	24	41.5		37.5	MKX14W36807C00_____
	15	26	41.5		37.5	MKX14W36807D00_____
	17	29	41.5		37.5	MKX14W36807E00_____
0.82 "	15	26	31.5		27.5	MKX14W38206F00_____
	17	34.5	31.5		27.5	MKX14W38206I00_____
	13	24	41.5		37.5	MKX14W38207C00_____
	17	29	41.5		37.5	MKX14W38207E00_____
	19	32	41.5		37.5	MKX14W38207F00_____

* f = 50/60 Hz

** PCM = Printed circuit module = pin spacing

Dims. in mm.

d = 0.8 Ø if PCM ≤ 27.5
d = 1.0 Ø if PCM = 37.5

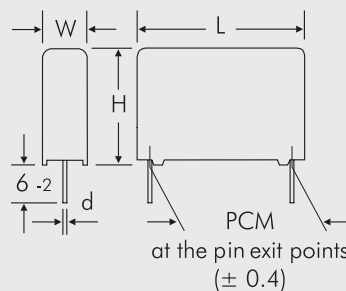

Part number completion:

Tolerance: 20 % = M

10 % = K

5 % = J

Packing: bulk = S

Pin length: 6-2 = SD

Taped version see page 157.

Rights reserved to amend design data without prior notification.

Continuation

General Data

Capacitance	440 VAC*				PCM**	Part number
	W	H	L			
1.0 μ F	17	29	31.5		27.5	MKX14W41006G00_____
	20	39.5	31.5		27.5	MKX14W41006J00_____
	15	26	41.5		37.5	MKX14W41007D00_____
	17	29	41.5		37.5	MKX14W41007E00_____
	20	39.5	41.5		37.5	MKX14W41007G00_____
1.2 "	17	34.5	31.5		27.5	MKX14W41206I00_____
	17	29	41.5		37.5	MKX14W41207E00_____
1.5 "	20	39.5	31.5		27.5	MKX14W41506J00_____
	19	32	41.5		37.5	MKX14W41507F00_____
1.8 "	19	32	41.5		37.5	MKX14W41807F00_____
2.2 "	20	39.5	41.5		37.5	MKX14W42207G00_____

* f = 50/60 Hz

** PCM = Printed circuit module = pin spacing

Dims. in mm.

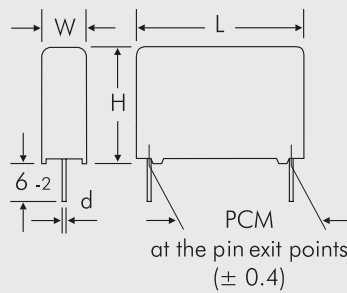

Part number completion:	
Tolerance:	20 % = M
	10 % = K
	5 % = J
Packing:	bulk = S
Pin length:	6-2 = SD
Taped version see page 157.	

d = 0.8 \varnothing if PCM = 27.5
d = 1.0 \varnothing if PCM = 37.5

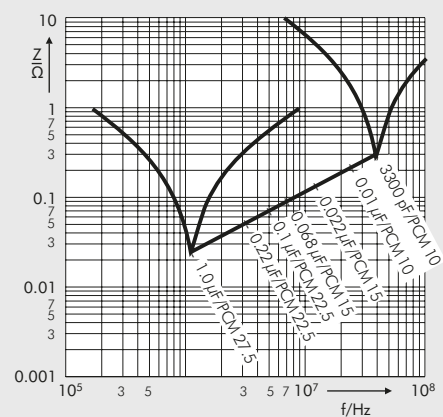

Impedance change with frequency (general guide).

Rights reserved to amend design data without prior notification.

WIMA Filter Capacitors



WIMA MKP 4F

Due to their typical circuit position AC filter capacitors have to exhibit good high-frequency characteristics and at the same time high AC voltage capabilities. They in general fulfil two requirements:

- Low AC impedance to dissipate high-frequency interference signals
- Attenuation of transient voltage pulses caused e.g. by switching.

WIMA filter capacitors are designed on the basis of low-loss Polypropylene film and exhibit high AC current capability at high frequencies as well as low ESL and ESR values.

They are available with capacitances from

0.68 μF up to 75 μF and rated voltages of 250 VAC, 275 VAC, 305 VAC, 350 VAC and 440 VAC for an operational temperature range of -55°C to $+105^\circ\text{C}$. The 440 VAC range has an internal series connection and stands out for an increased corona discharge inception voltage.

Their metallized construction, i.e. a thin aluminium layer serving as electrode being vapour-deposited onto the insulating film, entails very good self-healing properties of WIMA filter capacitors in case of a dielectric breakdown. The short-circuit current causes the thin metal layer to vaporize around the discharge channel and thus forming an insulating "halo". The capacitor remains fully operative.

Further positive features are the dry construction and thus the waiver of additional impregnating agents, the very favourable capacitance/volume ratio and the long life time at high capacitance long-term stability even under demanding operating conditions.

WIMA capacitors are produced with the proven box technology using solvent-resistant, flame-retardant plastic cases according to UL 94 V-0. They are environmentally compatible with the RoHS 2015/863/EU regulations of the European Union.



WIMA MKP 4F



Metallized Polypropylen (PP) Filter Capacitors
in PCM 27.5 mm to 52.5 mm. Capacitances from 0.68 μ F to 75 μ F.
Rate Voltages from 230 VAC to 440 VAC.

Special Features

- High volume/capacitance ratio
- High peak current capabilities
- Self-healing
- Long lifetime
- AEC-Q200 qualified
- According to RoHS 2015/863/EU

Typical Applications

- For high frequency applications e.g.
- AC filtering in UPS systems
 - Harmonic filter
 - Welding equipment
 - Renewable energy - grid interface

Construction

Dielectric:

Polypropylene (PP) film

Capacitor electrodes:

Vacuum-deposited

Internal construction:

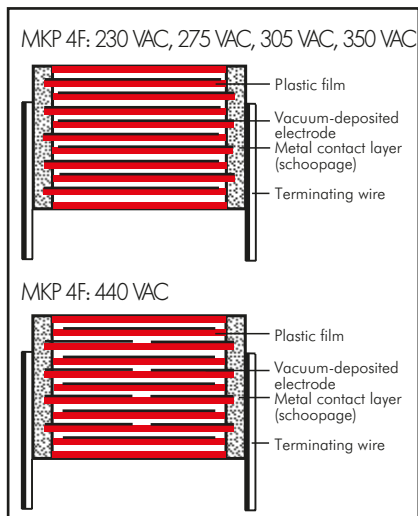

Encapsulation:

Solvent-resistant, flame-retardant plastic case with epoxy resin seal, UL 94 V-0

Terminations:

Tinned wire.

Marking:

Colour: Red. Marking: Black.

Electrical Data

Capacitance range:

0.68 μ F to 75 μ F

Rated voltages: 230 VAC, 275 VAC, 305 VAC, 350 VAC, 440 VAC

Capacitance tolerances:

$\pm 20\%$, $\pm 10\%$, $\pm 5\%$

Operating temperature range:

-55° C to $+105^{\circ}$ C

Climatic test category:

55/105/56 in accordance with IEC

Insulation resistance at $+20^{\circ}$ C:

$\geq 30\,000$ sec ($M\Omega \times \mu$ F)

Measuring voltage: 100 V/1 min.

Test voltage:

$1.5 U_{rDC}$, 10sec.

Test specifications:

In accordance with IEC 61071 and 60068

Dissipation factors at $+20^{\circ}$ C: $\tan \delta$

at f	PCM 27.5	PCM 37.5	PCM 52.5
1 kHz	$\leq 5 \times 10^{-4}$	$\leq 10 \times 10^{-4}$	$\leq 15 \times 10^{-4}$
10 kHz	$\leq 20 \times 10^{-4}$	$\leq 45 \times 10^{-4}$	$\leq 90 \times 10^{-4}$

Reference frequency 1 kHz in accordance with IEC 60384-1

Maximum pulse rise time:

PCM	max. pulse rise time V/ μ sec at $T_A < 40^{\circ}$ C				
	230 VAC	275 VAC	305 VAC	350 VAC	440 VAC
27.5	45	55	68	100	110
37.5	20	30	35	50	70
52.5	10	13	15	25	40

for pulses equal to the rated voltage (U_{rDC})

Mechanical Tests

Pull test on pins:

10 N in direction of pins according to IEC 60068-2-21

Vibration:

6 hours at 10...2000 Hz and 0.75 mm displacement amplitude or 10 g in accordance with IEC 60068-2-6

Low air density:

1 kPa = 10 mbar in accordance with IEC 60068-2-13

Bump test:

4000 bumps at 390 m/sec² in accordance with IEC 60068-2-29

Voltage derating:

A voltage derating factor must be applied according to the graph:

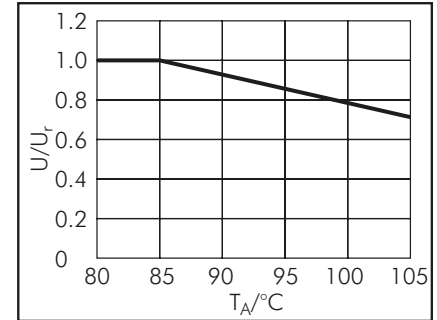

Reliability:

Operational life > 60000 hours at U_r
 Failure rate < 10 fit ($0.5 \times U_r$ and 40° C)

Packing

Available taped and reeled up to and including case size 15 x 26 x 31.5 / PCM 27.5 mm.

Detailed taping information and graphs at the end of the catalogue.

For further details and graphs please refer to Technical Information.

Continuation

General Data

Capacitance	W	H	L	PCM**	Pin	230 VAC*/450 VDC		Part number
						I _s A	I _{rms} (10 kHz) at 85° C A	
1.0 μF	9	19	31.5	27.5	2	45	2.5	MKPF3Y41006A_____
1.5 "	11	21	31.5	27.5	2/4	70	3	MKPF3Y41506B_____
2.2 "	11	21	31.5	27.5	2/4	100	3.5	MKPF3Y42206B_____
3.3 "	13	24	31.5	27.5	2/4	150	5	MKPF3Y43306D_____
4.7 "	15	26	31.5	27.5	2/4	210	7.5	MKPF3Y44706F_____
6.8 "	17	29	31.5	27.5	2/4	300	8.5	MKPF3Y46806G_____
10 μF	20	39.5	31.5	27.5	2/4	450	11.5	MKPF3Y51006J_____
	19	32	41.5	37.5	2/4	200	8	MKPF3Y51007F_____
12 "	19	32	41.5	37.5	2/4	240	10	MKPF3Y51207F_____
15 "	20	39.5	41.5	37.5	2/4	300	12	MKPF3Y51507G_____
20 "	24	45.5	41.5	37.5	2/4	400	14	MKPF3Y52007H_____
22 "	24	45.5	41.5	37.5	2/4	440	15	MKPF3Y52207H_____
25 "	31	46	41.5	37.5	2/4	500	17	MKPF3Y52507I_____
30 "	31	46	41.5	37.5	2/4	600	19	MKPF3Y53007I_____
	25	45	57	52.5	2/4	300	15	MKPF3Y53009D_____
35 "	35	50	41.5	37.5	2/4	700	20.5	MKPF3Y53507J_____
	25	45	57	52.5	2/4	350	15	MKPF3Y53509D_____
40 "	30	45	57	52.5	2/4	400	17.5	MKPF3Y54009E_____
45 "	30	45	57	52.5	2/4	450	18.5	MKPF3Y54509E_____
50 "	35	50	57	52.5	4	500	21	MKPF3Y55009F_____
55 "	35	50	57	52.5	4	550	22	MKPF3Y55509F_____
60 "	45	55	57	52.5	4	600	23	MKPF3Y56009H_____
65 "	45	55	57	52.5	4	650	25.5	MKPF3Y56509H_____
70 "	45	55	57	52.5	4	700	26	MKPF3Y57009H_____
75 "	45	65	57	52.5	4	750	27	MKPF3Y57509J_____

* AC voltages: $f \leq 100$ Hz

** PCM = Printed circuit module = pin spacing

Dims. in mm.

Part number completion:	
Version code:	2-pin = 00
	4-pin = D4
Tolerance:	20 % = M
	10 % = K
	5 % = J
Packing:	bulk = S
Pin length:	6-2 = SD
Taped version see page 157.	

2-pin version

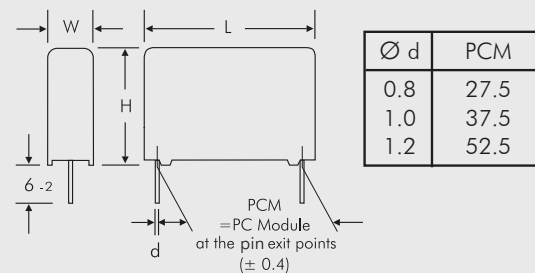

4-pin version

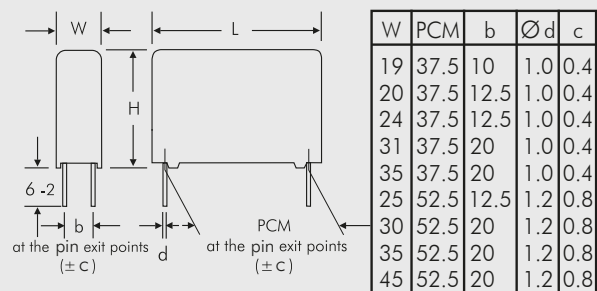

Rights reserved to amend design data without prior notification.

Continuation page 105

Continuation

General Data

Capacitance	W	H	L	PCM**	Pin	275 VAC*/600 VDC		Part number
						I_s A	I_{rms} (10 kHz) at 85° C A	
1.0 μ F	9	19	31.5	27.5	2	55	2.5	MKPF1W41006A
1.5 "	11	21	31.5	27.5	2/4	80	3.5	MKPF1W41506B
2.2 "	13	24	31.5	27.5	2/4	120	5	MKPF1W42206D
3.3 "	15	26	31.5	27.5	2/4	180	5.5	MKPF1W43306F
4.7 "	17	34.5	31.5	27.5	2/4	260	8	MKPF1W44706I
6.8 "	20	39.5	31.5	27.5	2/4	370	10	MKPF1W46806J
10 μ F	20	39.5	41.5	37.5	2/4	300	10	MKPF1W51007G
12 "	20	39.5	41.5	37.5	2/4	360	12	MKPF1W51207G
15 "	24	45.5	41.5	37.5	2/4	450	14	MKPF1W51507H
20 "	25	45	57	52.5	2/4	195	11	MKPF1W51509D
	31	46	41.5	37.5	2/4	600	16	MKPF1W52007I
22 "	25	45	57	52.5	2/4	260	12	MKPF1W52009D
	25	45	57	52.5	2/4	286	14	MKPF1W52209D
25 "	30	45	57	52.5	2/4	325	16	MKPF1W52509E
30 "	35	50	57	52.5	4	390	17	MKPF1W53009F
35 "	35	50	57	52.5	4	455	20	MKPF1W53509F
40 "	45	55	57	52.5	4	520	21	MKPF1W54009H
45 "	45	55	57	52.5	4	585	23	MKPF1W54509H
50 "	45	65	57	52.5	4	650	24	MKPF1W55009J

* AC voltages: $f \leq 100$ Hz

** PCM = Printed circuit module = pin spacing

Dims. in mm.

Part number completion:	
Version code:	2-pin = 00 4-pin = D4
Tolerance:	20 % = M 10 % = K 5 % = J
Packing:	bulk = S
Pin length:	6-2 = SD
Taped version see page 157.	

2-pin version

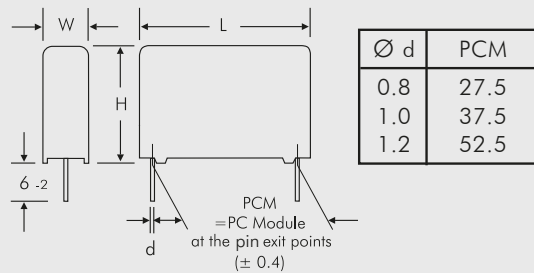

4-pin version

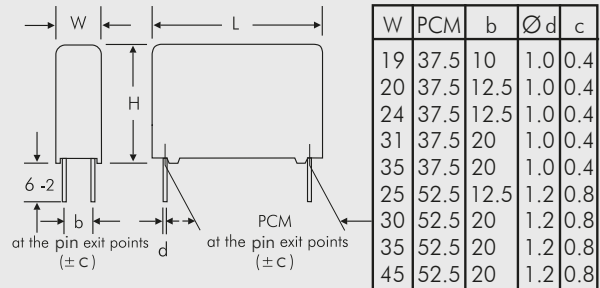

Rights reserved to amend design data without prior notification.

Continuation page 106

Continuation

General Data

Capacitance	W	H	L	PCM**	Pin	305 VAC*/630 VDC		Part number
						I_s A	I_{rms} (10 kHz) at 85° C A	
0.68 μ F	9	19	31.5	27.5	2	50	2	MKPCFAW36806A_____
1.0 μ F	11	21	31.5	27.5	2/4	68	3	MKPCFAW41006B_____
1.5 "	13	24	31.5	27.5	2/4	110	4	MKPCFAW41506D_____
2.2 "	15	26	31.5	27.5	2/4	150	5	MKPCFAW42206F_____
3.3 "	17	29	31.5	27.5	2/4	220	7	MKPCFAW43306G_____
4.7 "	20	39.5	31.5	27.5	2/4	320	9	MKPCFAW44706J_____
6.8 "	20	39.5	41.5	37.5	2/4	245	10	MKPCFAW46807G_____
10 μ F	24	45.5	41.5	37.5	2/4	350	12	MKPCFAW51007H_____
	25	45	57	52.5	2/4	150	10	MKPCFAW51009D_____
12 "	24	45.5	41.5	37.5	2/4	420	13	MKPCFAW51207H_____
15 "	31	46	41.5	37.5	2/4	525	15	MKPCFAW51507I_____
	25	45	57	52.5	2/4	225	13	MKPCFAW51509D_____
20 "	40	55	41.5	37.5	2/4	700	19	MKPCFAW52007K_____
	30	45	57	52.5	2/4	300	14	MKPCFAW52009E_____
22 "	35	50	57	52.5	4	330	16	MKPCFAW52209F_____
25 "	35	50	57	52.5	4	375	17	MKPCFAW52509F_____
30 "	45	55	57	52.5	4	450	21	MKPCFAW53009H_____
35 "	45	65	57	52.5	4	525	22	MKPCFAW53509J_____

* AC voltages: $f \leq 100$ Hz

** PCM = Printed circuit module = pin spacing

Dims. in mm.

Part number completion:	
Version code:	2-pin = 00 4-pin = D4
Tolerance:	20 % = M 10 % = K 5 % = J
Packing:	bulk = S
Pin length:	6-2 = SD
Taped version see page 157.	

2-pin version

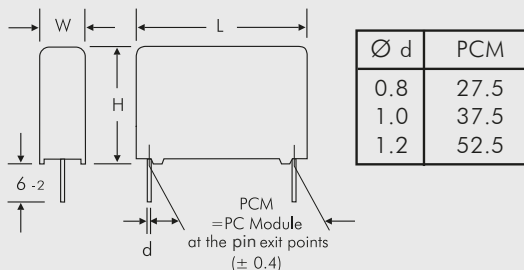

4-pin version

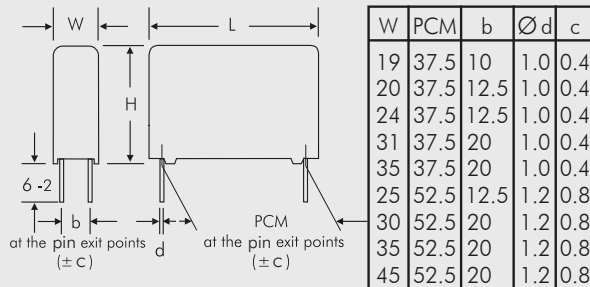

Rights reserved to amend design data without prior notification.

Continuation page 107



Continuation

General Data

Capacitance	W	H	L	PCM**	Pin	350 VAC*/700 VDC		Part number
						I _s A	I _{rms} (10kHz) at 85° C A	
0.68 µF	9	19	31.5	27.5	2	70	1.5	MKPFBW36806A_____
1.0 µF	11	21	31.5	27.5	2/4	100	3	MKPFBW41006B_____
1.5 "	13	24	31.5	27.5	2/4	150	4	MKPFBW41506D_____
2.2 "	15	26	31.5	27.5	2/4	220	5	MKPFBW42206F_____
3.3 "	17	29	31.5	27.5	2/4	330	7	MKPFBW43306G_____
4.7 "	20	39.5	31.5	27.5	2/4	470	11	MKPFBW44706J_____
6.8 "	20	39.5	41.5	37.5	2/4	340	10	MKPFBW46807G_____
10 µF	24	45.5	41.5	37.5	2/4	500	13	MKPFBW51007H_____
	25	45	57	52.5	2/4	250	11	MKPFBW51009D_____
12 "	24	45.5	41.5	37.5	2/4	600	14	MKPFBW51207H_____
15 "	31	46	41.5	37.5	2/4	750	16	MKPFBW51507I_____
	25	45	57	52.5	2/4	375	13	MKPFBW51509D_____
20 "	40	55	41.5	37.5	2/4	1000	18	MKPFBW52007K_____
	30	45	57	52.5	2/4	500	16	MKPFBW52009E_____
22 "	35	50	57	52.5	4	550	18	MKPFBW52209F_____
25 "	35	50	57	52.5	4	625	19	MKPFBW52509F_____
30 "	45	55	57	52.5	4	750	22	MKPFBW53009H_____
35 "	45	65	57	52.5	4	870	25	MKPFBW53509J_____

Capacitance	W	H	L	PCM**	Pin	440 VAC*/1000 VDC		Part number
						I _s A	I _{rms} (10kHz) at 85° C A	
0.68 µF	13	24	31.5	27.5	2/4	74.8	3	MKPF4W36806D_____
1.0 µF	13	24	31.5	27.5	2/4	110	4	MKPF4W41006D_____
1.5 "	17	29	31.5	27.5	2/4	165	5	MKPF4W41506G_____
2.2 "	20	39.5	31.5	27.5	2/4	240	6	MKPF4W42206J_____
3.3 "	20	39.5	41.5	37.5	2/4	230	7.5	MKPF4W43307G_____
4.7 "	24	45.5	41.5	37.5	2/4	330	8.5	MKPF4W44707H_____
6.8 "	31	46	41.5	37.5	2/4	480	11.5	MKPF4W46807I_____
10 µF	30	45	57	52.5	2/4	400	16	MKPF4W51009E_____
12 "	35	50	57	52.5	4	480	17	MKPF4W51209F_____

* AC voltages: $f \leq 100$ Hz

** PCM = Printed circuit module = pin spacing

Dims. in mm.

Part number completion:	
Version code:	2-pin = 00 4-pin = D4
Tolerance:	20 % = M 10 % = K 5 % = J
Packing:	bulk = S
Pin length:	6-2 = SD
Taped version see page 157.	

Rights reserved to amend design data without prior notification.

Continuation page 108

Continuation

Impedance change with frequency
(general guide).

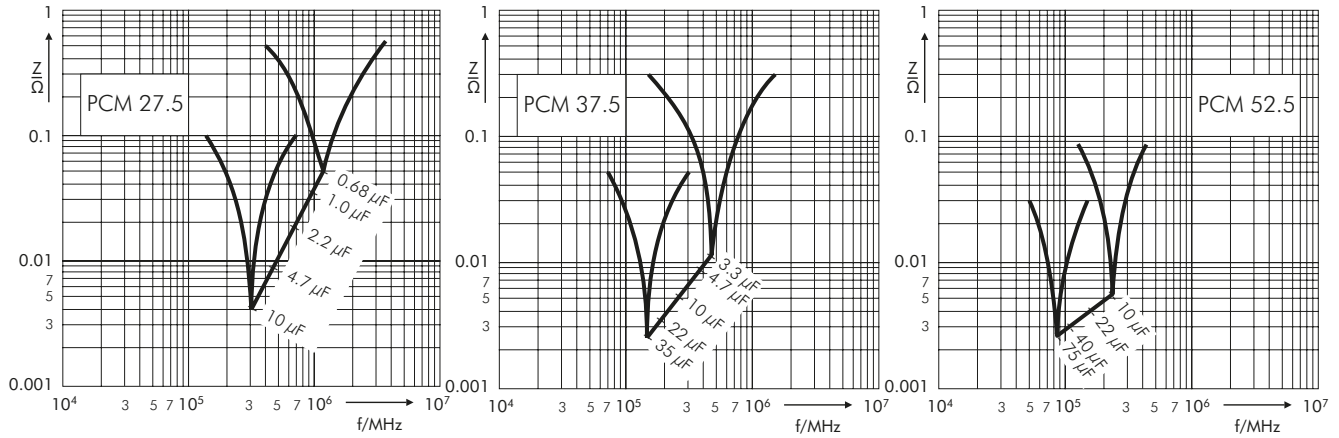

Permissible AC voltage in relation to frequency at 10° C internal temperature rise (general guide).

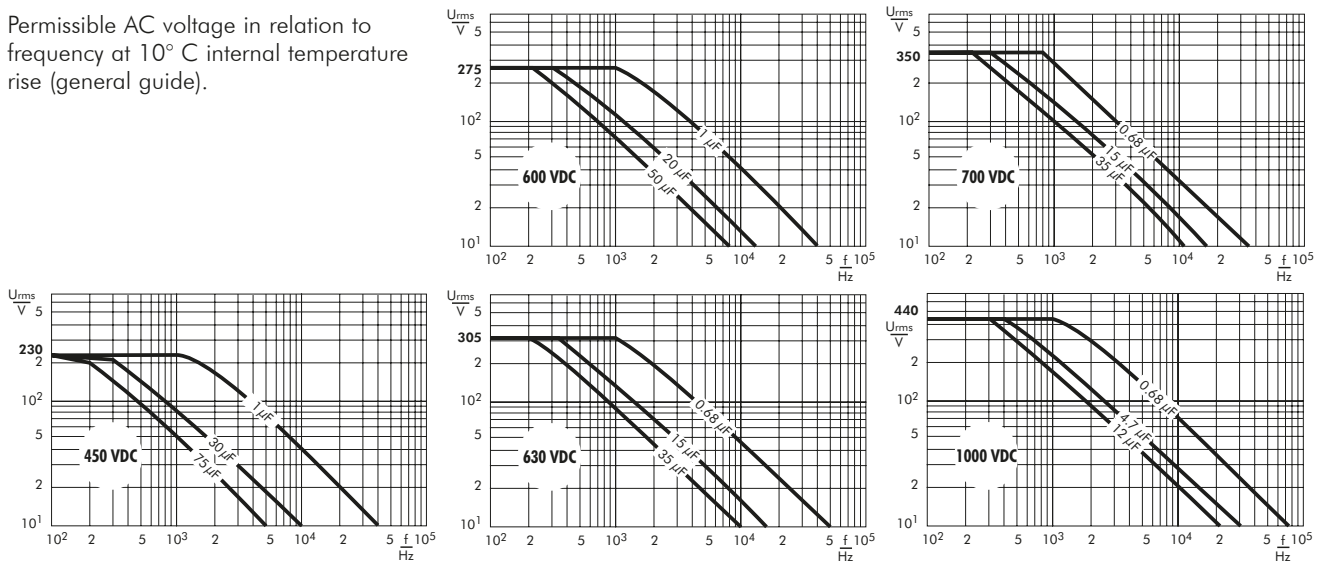

Permissible AC current in relation to frequency at 10° C internal temperature rise (general guide).

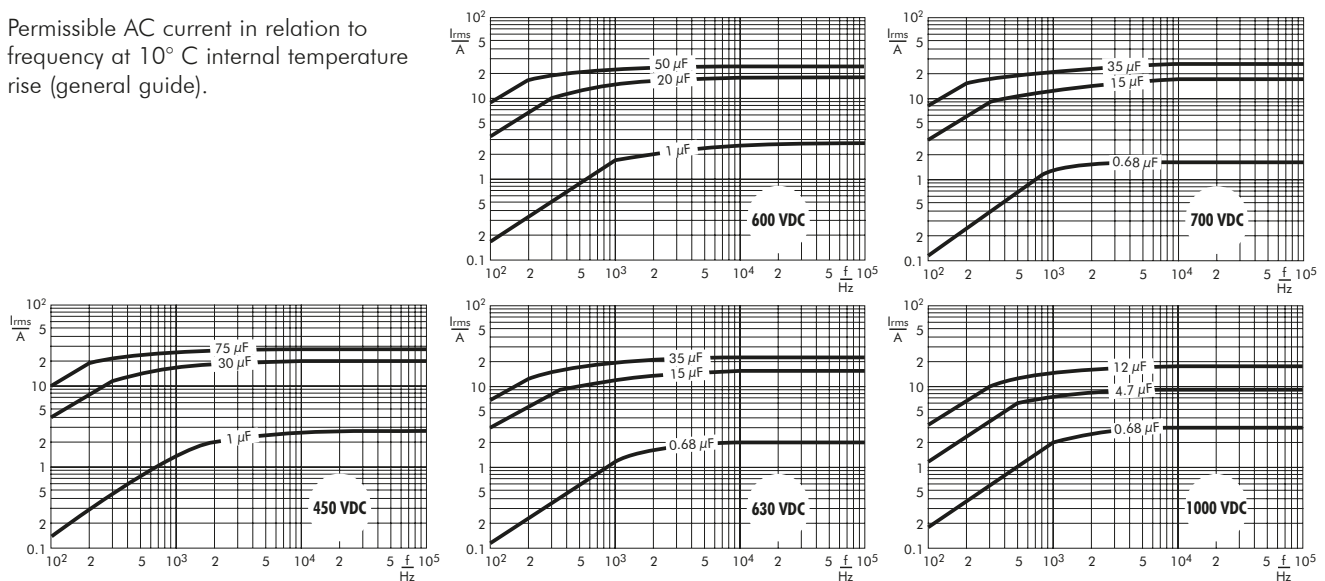

WIMA Snubber Capacitors with Plates or Lead Terminations for Best Contacts



WIMA Snubber MKP

WIMA Snubber FKP

Development of the WIMA Snubber MKP and WIMA Snubber FKP capacitor series for high power conversion is based on decades of experience with Polypropylene film pulse capacitors.

WIMA Snubber capacitors are available both as double-sided metallized pulse version – WIMA Snubber MKP – and for extremely high pulse ratings in self-healing film/foil technology – WIMA Snubber FKP. Their electrical performance as well as the manifold number of available connecting options makes the WIMA Snubber technology unique:

- Plates soldered directly to the schoopage for safe contacts at high rms currents

- Low inductance construction achieved by end-surface contacts
- High pulse reliability due to double-sided metallization and/or film/foil construction
- High voltage/overvoltage strength by internal series connection with self-healing metallized floating electrode
- Available in various contact configurations
- Solvent-resistant, flame retardant plastic case in accordance with UL 94 V-0
- Production sites ISO 9001:2015 certified

WIMA Snubber capacitors are manufactured under conditions of large volume production, but are also available in small quantities as individually configurable high-rel. components.

WIMA Snubber capacitors are available with capacitances from 0.01 μF through 8.0 μF and with rated voltages from 630 VDC through 4000 VDC.

All components are environmentally compatible with the RoHS 2015/863/EU regulations of the European Union.



Snubber MKP Capacitors for Pulse Applications with Double-Sided Metallized Electrodes and Internal Series Connection. Capacitances from 0.047 µF to 8.0 µF. Rated Voltages from 700 VDC to 3000 VDC.

Special Features

- Pulse duty construction
- Self-healing
- Particularly reliable contact-configurations: 4-pin versions and screwable plate connections
- Internal series connection
- Very low dissipation factor
- Negative capacitance change versus temperature
- AEC-Q200 qualified 
- According to RoHS 2015/863/EU

Typical Applications

For high pulse and high frequency applications requiring extremely reliable contacts e.g.

- IGBT-applications

Construction

Dielectric:

Polypropylene (PP) film

Capacitor electrodes:

Double-sided metallized plastic film

Internal construction:

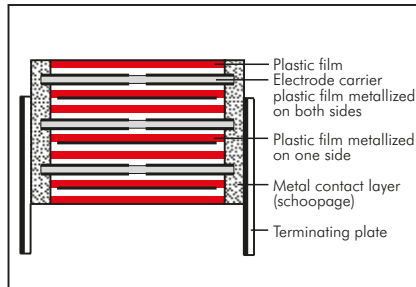

Encapsulation:

Solvent-resistant, flame-retardant plastic case with epoxy resin seal, UL 94 V-0

Terminations:

Tinned wire or plates.

Marking:

Colour: Red. Marking: Black.

Electrical Data

Capacitance range: 0.047 µF to 8.0 µF

Rated voltages: 700 VDC, 850 VDC, 1000 VDC, 1250 VDC, 1700 VDC, 2000 VDC, 2500 VDC, 3000 VDC

Capacitance tolerances: ±20%, ±10%, ±5% (other tolerances are available subject to special enquiry)

Operating temperature range: -55° C to +105° C

Insulation resistance at +20° C:

C ≤ 0.33 µF: ≥ 1 x 10⁵ MΩ

C > 0.33 µF: ≥ 30000 sec (MΩ x µF)

Measuring voltage: 100 V/1 min.

Test voltage: 2 sec

L	≤2000VDC	2500VDC	≥3000VDC
<41.5	1.6 U _r	1.4 U _r	1.2 U _r
41.5	1.4 U _r	1.4 U _r	1.2 U _r
56	1.2 U _r	1.2 U _r	1.2 U _r

Dissipation factors at +20° C: tan δ

at f	C ≤ 0.1 µF	0.1 µF < C ≤ 1.0 µF	C > 1.0 µF
1 kHz	≤ 6 x 10 ⁻⁴	≤ 6 x 10 ⁻⁴	≤ 6 x 10 ⁻⁴
10 kHz	≤ 6 x 10 ⁻⁴	≤ 6 x 10 ⁻⁴	–
100 kHz	≤ 15 x 10 ⁻⁴	–	–

* other box sizes see page 11.

Maximum pulse rise time:

Capacitance µF	max. pulse rise time V/µsec at T _A < 40° C							
	700VDC	850VDC	1000VDC	1250VDC	1700VDC	2000VDC	2500VDC	3000VDC
0.047... 0.22	1150	1150	1800	1800	1800	1800	1800	1800
0.33 ... 0.68	900	900	1150	1150	1150	1150	1150	1150
1.0 ... 2.2	500	500	500	500	650	650	650	650
2.5 ... 6.8	190	190	390	390	500	–	–	–
7.0 ... 8.0	90	90	–	–	–	–	–	–

Mounting Recommendation

Excessive mechanical strain, e.g. pressure or shock onto the capacitor body, is to be avoided during mounting and usage of the capacitors. When fixing the plates the screw torque is to be limited to max. 5 Nm.

For further details and graphs please refer to Technical Information.

Packing

Packing units at the end of the catalogue.

Packing quantities may vary depending on the plate version.

Climatic test category:

55/100/56 in accordance with IEC

Voltage derating:

A voltage derating factor of 1.35 % per K must be applied from +85° C for DC voltages and from +75° C for AC voltages

Reliability:

Operational life > 300000 hours

Failure rate < 1 fit (0.5 x U_r and 40° C)

Specific dissipation:

Box size* WxHxL in mm	Specific dissipation in Watts per K above the ambient temperature
19x31x56	0.068
23x34x56	0.079
27x37.5x56	0.092
33x48x56	0.122
37x54x56	0.142

Continuation

General Data

Capacitance	700 VDC/420 VAC*				850 VDC/450 VAC*				1000 VDC/600 VAC*				
	W	H	L	Part number	W	H	L	Part number	W	H	L	Part number	
0.22 μ F										11	21	31.5	SNMPO132206B
										11	22	41.5	SNMPO132207B
0.33 "					15	26	31.5	SNMPM033306F		15	26	31.5	SNMPO133306F
					13	24	41.5	SNMPM033307C		13	24	41.5	SNMPO133307C
0.47 "	11	21	31.5	SNMPK034706B	17	29	31.5	SNMPM034706G		17	29	31.5	SNMPO134706G
	11	22	41.5	SNMPK034707B	15	26	41.5	SNMPM034707D		15	26	41.5	SNMPO134707D
0.68 "	15	26	31.5	SNMPK036806F	17	29	41.5	SNMPM036807E		17	29	41.5	SNMPO136807E
	13	24	41.5	SNMPK036807C									
1.0 μ F	17	29	31.5	SNMPK041006G	19	32	41.5	SNMPM041007F		20	39.5	41.5	SNMPO141007G
	15	26	41.5	SNMPK041007D						23	34	56	SNMPO141008E
1.5 "	19	32	41.5	SNMPK041507F	20	39.5	41.5	SNMPM041507G		24	45.5	41.5	SNMPO141507H
					23	34	56	SNMPM041508E		23	34	56	SNMPO141508E
2.0 "	20	39.5	41.5	SNMPK042007G	24	45.5	41.5	SNMPM042007H		31	46	41.5	SNMPO142007I
					23	34	56	SNMPM042008E		27	37.5	56	SNMPO142008H
2.2 "	20	39.5	41.5	SNMPK042207G	24	45.5	41.5	SNMPM042207H		31	46	41.5	SNMPO142207I
					23	34	56	SNMPM042208E		27	37.5	56	SNMPO142208H
2.5 "	24	45.5	41.5	SNMPK042507H	31	46	41.5	SNMPM042507I		35	50	41.5	SNMPO142507J
					27	37.5	56	SNMPM042508H		33	48	56	SNMPO142508J
3.0 "	24	45.5	41.5	SNMPK043007H	31	46	41.5	SNMPM043007I		40	55	41.5	SNMPO143007K
					27	37.5	56	SNMPM043008H		33	48	56	SNMPO143008J
3.3 "	24	45.5	41.5	SNMPK043307H	35	50	41.5	SNMPM043307J		40	55	41.5	SNMPO143307K
					33	48	56	SNMPM043308J		33	48	56	SNMPO143308J
4.0 "	31	46	41.5	SNMPK044007I	35	50	41.5	SNMPM044007J		37	54	56	SNMPO144008L
					33	48	56	SNMPM044008J					
4.7 "	31	46	41.5	SNMPK044707I	33	48	56	SNMPM044708J		37	54	56	SNMPO144708L
5.0 "	31	46	41.5	SNMPK045007I	33	48	56	SNMPM045008J		37	54	56	SNMPO145008L
6.0 "	35	50	41.5	SNMPK046007J	37	54	56	SNMPM046008L		37	54	56	SNMPO146008L
	33	48	56	SNMPK046008J									
7.0 "	40	55	41.5	SNMPK047007K	37	54	56	SNMPM047008L					
	33	48	56	SNMPK047008J									
8.0 "	37	54	56	SNMPK048008L									

* AC voltages: $f \leq 1000$ Hz; $1.4 \times U_{rms} + UDC \leq U_r$

Dims. in mm.

Ionisation inception level in isolated cases may be lower than admissible rated AC voltage.

Versions and dimensional drawings see page 120.

Part number completion:

Version codes see page 122.

Tolerance: 20 % = M

10 % = K

5 % = J

Packing: bulk = S

Pin length: 6-2 = SD

none = 00 (for plate versions)

Rights reserved to amend design data without prior notification.

Continuation page 112

Continuation

General Data

Capacitance	1250 VDC/600 VAC*				1700 VDC/650 VAC*				2000 VDC/700 VAC*			
	W	H	L	Part number	W	H	L	Part number	W	H	L	Part number
0.068 μ F									11	21	31.5	SNMPTA31006B
									11	22	41.5	SNMPTA31007B
0.1 μ F					11	21	31.5	SNMPTA31006B	13	24	31.5	SNMPTA31006D
					11	22	41.5	SNMPTA31007B	11	22	41.5	SNMPTA31007B
0.15 "					13	24	31.5	SNMPTA31506D	15	26	31.5	SNMPTA31506F
					11	22	41.5	SNMPTA31507B	13	24	41.5	SNMPTA31507C
0.22 "	11	21	31.5	SNMPTA32206B	15	26	31.5	SNMPTA32206F	15	26	41.5	SNMPTA32207D
	11	22	41.5	SNMPTA32207B	13	24	41.5	SNMPTA32207C				
0.33 "	15	26	31.5	SNMPTA33306F	17	34.5	31.5	SNMPTA33306I	19	32	41.5	SNMPTA33307F
	13	24	41.5	SNMPTA33307C	15	26	41.5	SNMPTA33307D				
0.47 "	17	29	31.5	SNMPTA34706G	19	32	41.5	SNMPTA34707F	20	39.5	41.5	SNMPTA34707G
	15	26	41.5	SNMPTA34707D					23	34	56	SNMPTA34708E
0.68 "	17	29	41.5	SNMPTA36807E	20	39.5	41.5	SNMPTA36807G	24	45.5	41.5	SNMPTA36807H
					23	34	56	SNMPTA36808E	27	37.5	56	SNMPTA36808H
1.0 μ F	20	39.5	41.5	SNMPTA41007G	24	45.5	41.5	SNMPTA41007H	35	50	41.5	SNMPTA41007J
	23	34	56	SNMPTA41008E	27	37.5	56	SNMPTA41008H	33	48	56	SNMPTA41008J
1.5 "	24	45.5	41.5	SNMPTA41507H	31	46	41.5	SNMPTA41507I	40	55	41.5	SNMPTA41507K
	23	34	56	SNMPTA41508E	27	37.5	56	SNMPTA41508H	33	48	56	SNMPTA41508J
2.0 "	31	46	41.5	SNMPTA42007I	40	55	41.5	SNMPTA42007K	37	54	56	SNMPTA42008L
	27	37.5	56	SNMPTA42008H	33	48	56	SNMPTA42008J				
2.2 "	31	46	41.5	SNMPTA42207I	40	55	41.5	SNMPTA42207K	37	54	56	SNMPTA42208L
	27	37.5	56	SNMPTA42208H	33	48	56	SNMPTA42208J				
2.5 "	35	50	41.5	SNMPTA42507J	37	54	56	SNMPTA42508L				
	33	48	56	SNMPTA42508J								
3.0 "	40	55	41.5	SNMPTA43007K	37	54	56	SNMPTA43008L				
	33	48	56	SNMPTA43008J								
3.3 "	40	55	41.5	SNMPTA43307K								
	33	48	56	SNMPTA43308J								
4.0 "	37	54	56	SNMPTA44008L								
4.7 "	37	54	56	SNMPTA44708L								
5.0 "	37	54	56	SNMPTA45008L								
6.0 "	37	54	56	SNMPTA46008L								

* AC voltages: $f \leq 1000$ Hz; $1.4 \times U_{rms} + UDC \leq U_r$

Dims. in mm.

Ionisation inception level in isolated cases may be lower than admissible rated AC voltage.

Versions and dimensional drawings see page 120.

Part number completion:
Version codes see page 122.
Tolerance: 20 % = M
10 % = K
5 % = J
Packing: bulk = S
Pin length: 6-2 = SD
none = 00 (for plate versions)

Rights reserved to amend design data without prior notification.

Continuation page 113

Continuation

General Data

Capacitance	2500 VDC/700 VAC*				3000 VDC/700 VAC*				
	W	H	L	Part number	W	H	L	Part number	
0.047 μ F	11	21	31.5	SNMPV024706B	11	21	31.5	SNMPW024706B	
	11	22	41.5	SNMPV024707B	11	22	41.5	SNMPW024707B	
	0.068 "	13	24	31.5	SNMPV026806D	13	24	31.5	SNMPW026806D
		11	22	41.5	SNMPV026807B	11	22	41.5	SNMPW026807B
0.1 μ F	15	26	31.5	SNMPV031006F	15	26	31.5	SNMPW031006F	
	13	24	41.5	SNMPV031007C	13	24	41.5	SNMPW031007C	
0.15 "	15	26	41.5	SNMPV031507D	15	26	41.5	SNMPW031507D	
0.22 "	19	32	41.5	SNMPV032207F	19	32	41.5	SNMPW032207F	
0.33 "	24	45.5	41.5	SNMPV033307H	24	45.5	41.5	SNMPW033307H	
0.47 "	31	46	41.5	SNMPV034707I	31	46	41.5	SNMPW034707I	
	27	37.5	56	SNMPV034708H	27	37.5	56	SNMPW034708H	
0.68 "	35	50	41.5	SNMPV036807J	35	50	41.5	SNMPW036807J	
	33	48	56	SNMPV036808J	33	48	56	SNMPW036808J	
1.0 μ F	40	55	41.5	SNMPV041007K	40	55	41.5	SNMPW041007K	
	33	48	56	SNMPV041008J	33	48	56	SNMPW041008J	
1.5 "	37	54	56	SNMPV041508L	37	54	56	SNMPW041508L	

* AC voltages: $f \leq 1000$ Hz; $1.4 \times U_{rms} + U_{DC} \leq U_r$

Dims. in mm.

Ionisation inception level in isolated cases may be lower than admissible rated AC voltage.

Versions and dimensional drawings see page 120.

Part number completion:

Version codes see page 122.

Tolerance: 20 % = M

10 % = K

5 % = J

Packing: bulk = S

Pin length: 6-2 = SD

none = 00 (for plate versions)

Rights reserved to amend design data without prior notification.

Impedance change with frequency (general guide) (examples).

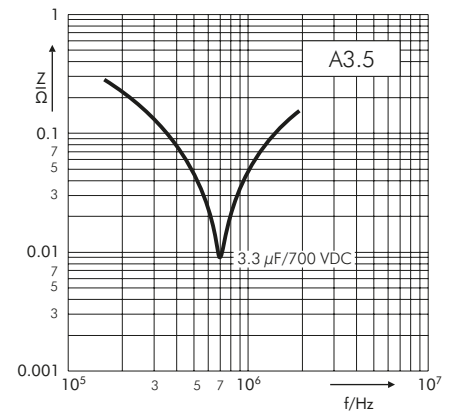
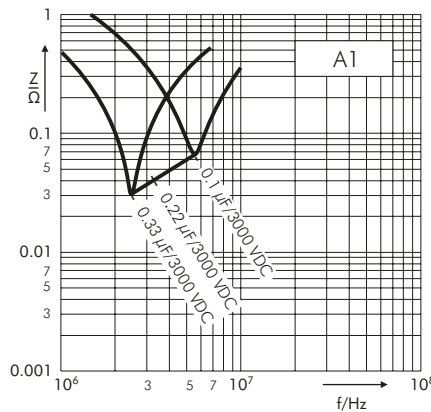

Continuation

Permissible AC voltage in relation to frequency till 15° C internal temperature rise (general guide).

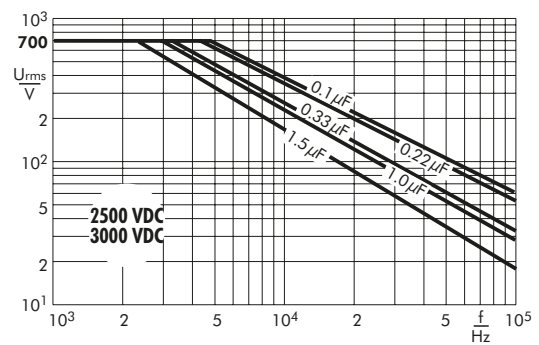
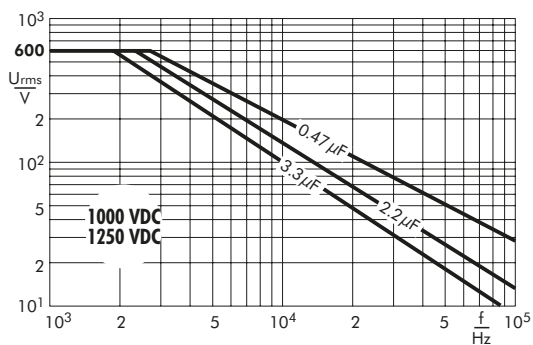
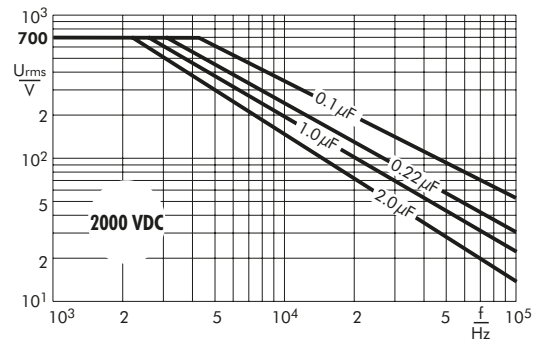
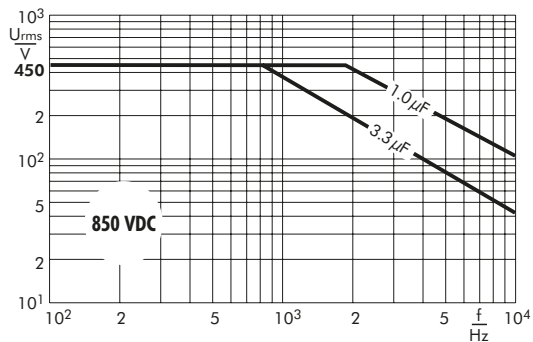
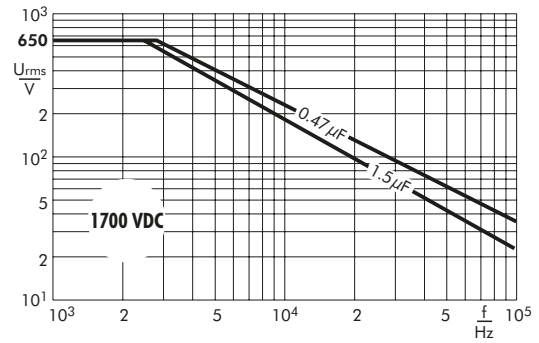
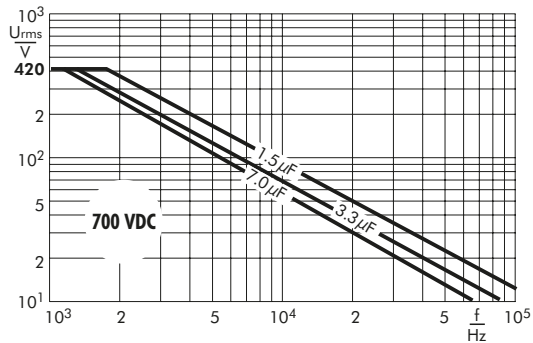

Continuation

Permissible AC current in relation to frequency till 15° C internal temperature rise (general guide).

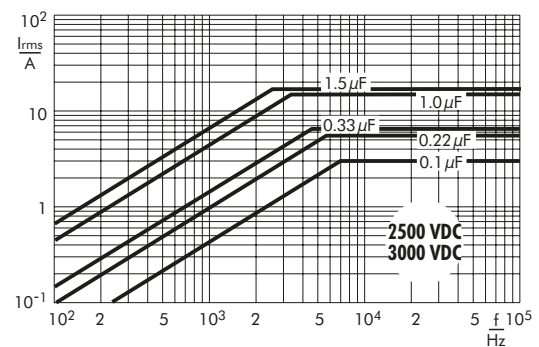
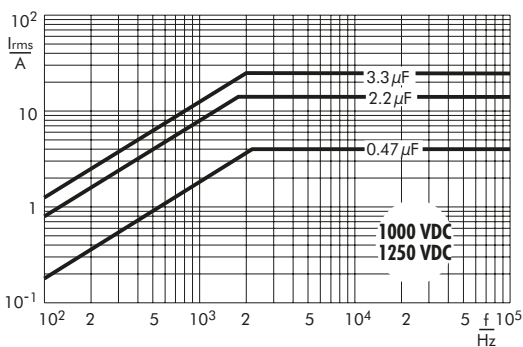
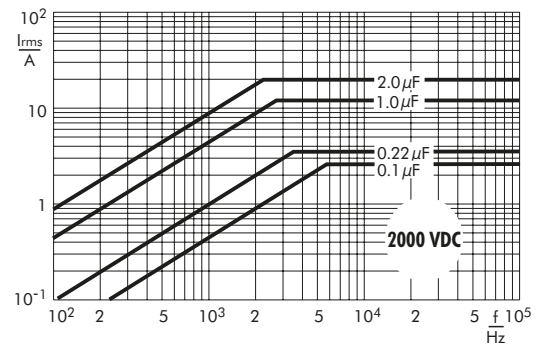
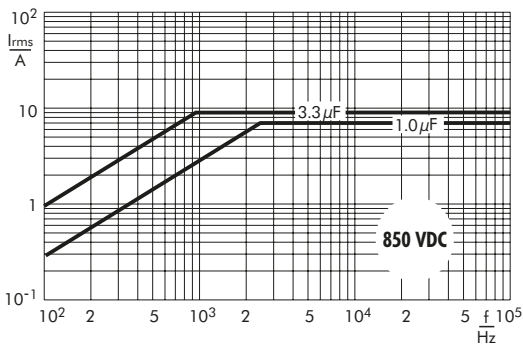
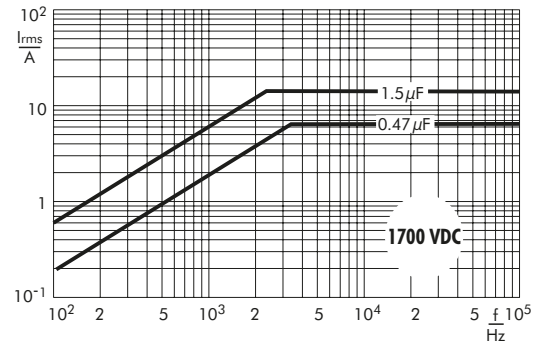
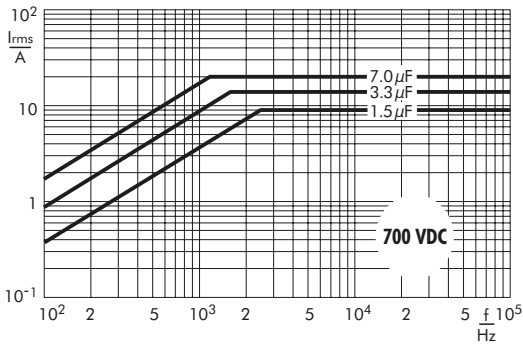

Snubber FKP Capacitors for High Pulse Applications with Metal Foil Electrodes and Metallized Internal Series Connection. Capacitances from 0.01 μF to 3.3 μF . Rated Voltages from 630 VDC to 4000 VDC.

Special Features

- High pulse duty
- Self-healing
- Particularly reliable contact-configurations: 4-pin versions and screwable plate connections
- Internal series connection
- Very low dissipation factor
- Negative capacitance change versus temperature
- AEC-Q200 qualified
- According to RoHS 2015/863/EU

Typical Applications

For high pulse and high frequency applications requiring extremely reliable contacts e.g.

- IGBT-applications

Construction

Dielectric:

Polypropylene (PP) film

Capacitor electrodes:

Aluminium foil and single-sided metallized plastic film

Internal construction:

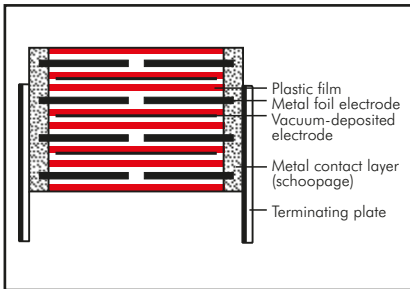

Encapsulation:

Solvent-resistant, flame-retardant plastic case with epoxy resin seal, UL 94 V-0

Terminations:

Tinned wire or plates.

Marking:

Colour: Red. Marking: Black.

Electrical Data

Capacitance range: 0.01 μF to 3.3 μF
Rated voltages: 630 VDC, 1000 VDC, 1250 VDC, 1600 VDC, 2000 VDC, 3000 VDC, 4000 VDC

Capacitance tolerances: $\pm 20\%$, $\pm 10\%$, $\pm 5\%$ (other tolerances are available subject to special enquiry)

Operating temperature range: -55°C to $+105^\circ\text{C}$

Insulation resistance at $+20^\circ\text{C}$:

$C \leq 0.33 \mu\text{F}$: $\geq 1 \times 10^5 \text{ M}\Omega$

$C > 0.33 \mu\text{F}$: $\geq 30000 \text{ sec (M}\Omega \times \mu\text{F)}$

Measuring voltage: 100 V/1 min.

Test voltage: 2 sec

L	$\leq 2000 \text{ VDC}$	$\geq 3000 \text{ VDC}$
< 41.5	$1.6 U_r$	$1.2 U_r$
41.5	$1.4 U_r$	$1.2 U_r$
56	$1.2 U_r$	$1.2 U_r$

Dissipation factors at $+20^\circ\text{C}$: $\tan \delta$

at f	$C \leq 0.1 \mu\text{F}$	$0.1 \mu\text{F} < C \leq 1.0 \mu\text{F}$	$C > 1.0 \mu\text{F}$
1 kHz	$\leq 5 \times 10^{-4}$	$\leq 5 \times 10^{-4}$	$\leq 5 \times 10^{-4}$
10 kHz	$\leq 6 \times 10^{-4}$	$\leq 6 \times 10^{-4}$	–
100 kHz	$\leq 10 \times 10^{-4}$	–	–

* other box sizes see page 11.

Maximum pulse rise time:

Capacitance μF	max. pulse rise time V/ μsec at $T_A < 40^\circ\text{C}$							
	630VDC	1000VDC	1250VDC	1600VDC	2000VDC	3000VDC	4000VDC	
0.01 ... 0.022	–	11000	11000	11000	11000	11000	11000	
0.033 ... 0.068	9000	9000	9000	9000	9000	9000	9000	
0.1 ... 0.22	9000	9000	9000	9000	9000	9000	9000	
0.33 ... 0.68	5000	5000	5000	5000	5000	5000	5000	
1.0 ... 3.3	1600	2000	2000	2000	–	–	–	

Mounting Recommendation

Excessive mechanical strain, e.g. pressure or shock onto the capacitor body, is to be avoided during mounting and usage of the capacitors. When fixing the plates the screw torque is to be limited to max. 5 Nm.

For further details and graphs please refer to Technical Information.

Packing

Packing units at the end of the catalogue.

Packing quantities may vary depending on the plate version.

Box size* WxHxL in mm	Specific dissipation in Watts per K above the ambient temperature
19x31x56	0.068
23x34x56	0.079
27x37.5x56	0.092
33x48x56	0.122
37x54x56	0.142

Continuation

General Data

Capacitance	630 VDC/400 VAC*				1000 VDC/600 VAC*			
	W	H	L	Part number	W	H	L	Part number
0.022 μ F					11	22	41.5	SNFPJ0122207B
0.033 "					11	22	41.5	SNFPJ0123307B
0.047 "	11	22	41.5	SNFPJ024707B	11	22	41.5	SNFPJ0124707B
0.068 "	11	22	41.5	SNFPJ026807B	11	22	41.5	SNFPJ0126807B
0.1 μ F	11	22	41.5	SNFPJ031007B	11	22	41.5	SNFPJ0131007B
0.15 "	11	22	41.5	SNFPJ031507B	15	26	41.5	SNFPJ0131507D
0.22 "	13	24	41.5	SNFPJ032207C	17	29	41.5	SNFPJ0132207E
0.33 "	15	26	41.5	SNFPJ033307D	19	32	41.5	SNFPJ0133307F
0.47 "	17	29	41.5	SNFPJ034707E	20	39.5	41.5	SNFPJ0134707G
0.68 "	19	32	41.5	SNFPJ036807F	24	45.5	41.5	SNFPJ0136807H
					23	34	56	SNFPJ0136808E
1.0 μ F	20	39.5	41.5	SNFPJ041007G	31	46	41.5	SNFPJ0141007I
					27	37.5	56	SNFPJ0141008H
1.5 "	24	45.5	41.5	SNFPJ041507H	35	50	41.5	SNFPJ0141507J
					33	48	56	SNFPJ0141508J
2.2 "	31	46	41.5	SNFPJ042207I	37	54	56	SNFPJ0142208L
	27	37.5	56	SNFPJ042208H				
2.5 "	35	50	41.5	SNFPJ042507J				
	33	48	56	SNFPJ042508J				
3.0 "	37	54	56	SNFPJ043008L				
3.3 "	37	54	56	SNFPJ043308L				

Capacitance	1250 VDC/600 VAC*				1600 VDC/650 VAC*			
	W	H	L	Part number	W	H	L	Part number
0.01 μ F					11	22	41.5	SNFPT021007B
0.015 "					11	22	41.5	SNFPT021507B
0.022 "	11	22	41.5	SNFPRO22207B	11	22	41.5	SNFPT022207B
0.033 "	11	22	41.5	SNFPRO23307B	11	22	41.5	SNFPT023307B
0.047 "	11	22	41.5	SNFPRO24707B	11	22	41.5	SNFPT024707B
0.068 "	11	22	41.5	SNFPRO26807B	15	26	41.5	SNFPT026807D
0.1 μ F	11	22	41.5	SNFPRO31007B	17	29	41.5	SNFPT031007E
0.15 "	15	26	41.5	SNFPRO31507D	19	32	41.5	SNFPT031507F
0.22 "	17	29	41.5	SNFPRO32207E	20	39.5	41.5	SNFPT032207G
0.33 "	19	32	41.5	SNFPRO33307F	24	45.5	41.5	SNFPT033307H
0.47 "	20	39.5	41.5	SNFPRO34707G	31	46	41.5	SNFPT034707I
					27	37.5	56	SNFPT034708H
0.68 "	24	45.5	41.5	SNFPRO36807H	35	50	41.5	SNFPT036807J
	23	34	56	SNFPRO36808E	27	37.5	56	SNFPT036808H
1.0 μ F	31	46	41.5	SNFPRO41007I	33	48	56	SNFPT041008J
	27	37.5	56	SNFPRO41008H				
1.5 "	33	48	56	SNFPRO41508J	37	54	56	SNFPT041508L
2.2 "	37	54	56	SNFPRO42208L				

* AC voltages: $f \leq 1000$ Hz; $1.4 \times U_{rms} + U_{DC} \leq U_r$

Dims. in mm.

Ionisation inception level in isolated cases may be lower than admissible rated AC voltage.

Versions and dimensional drawings see page 120.

Rights reserved to amend design data without prior notification.

Part number completion:

Version codes see page 122.

Tolerance: 20 % = M

10 % = K

5 % = J

Packing: bulk = S

Pin length: 6-2 = SD

none = 00 (for plate versions)

Continuation page 118

Continuation

General Data

Capacitance	2000 VDC/700 VAC*				3000 VDC/700 VAC*				4000 VDC/700 VAC*			
	W	H	L	Part number	W	H	L	Part number	W	H	L	Part number
0.01 μF	11	22	41.5	SNFPU021007B	11	22	41.5	SNFPW021007B	11	22	41.5	SNFPX021007B
0.015 "	11	22	41.5	SNFPU021507B	11	22	41.5	SNFPW021507B	11	22	41.5	SNFPX021507B
0.022 "	11	22	41.5	SNFPU022207B	11	22	41.5	SNFPW022207B	13	24	41.5	SNFPX022207C
0.033 "	13	24	41.5	SNFPU023307C	13	24	41.5	SNFPW023307C	15	26	41.5	SNFPX023307D
0.047 "	15	26	41.5	SNFPU024707D	15	26	41.5	SNFPW024707D	17	29	41.5	SNFPX024707E
0.068 "	17	29	41.5	SNFPU026807E	17	29	41.5	SNFPW026807E	19	32	41.5	SNFPX026807F
0.1 μF	17	29	41.5	SNFPU031007E	19	32	41.5	SNFPW031007F	20	39.5	41.5	SNFPX031007G
0.15 "	20	39.5	41.5	SNFPU031507G	20	39.5	41.5	SNFPW031507G	24	45.5	41.5	SNFPX031507H
0.22 "	24	45.5	41.5	SNFPU032207H	24	45.5	41.5	SNFPW032207H	31	46	41.5	SNFPX032207I
0.33 "	31	46	41.5	SNFPU033307I	31	46	41.5	SNFPW033307I	27	37.5	56	SNFPX032208H
0.47 "	27	37.5	56	SNFPU033308H	27	37.5	56	SNFPW033308H	33	48	56	SNFPX033308J
0.68 "	31	46	41.5	SNFPU034707J	33	48	56	SNFPW034708J	37	54	56	SNFPX034708L
0.68 "	27	37.5	56	SNFPU034708H								
0.68 "	33	48	56	SNFPU036808J								

* AC voltages: $f \leq 1000 \text{ Hz}$; $1.4 \times U_{\text{rms}} + \text{UDC} \leq U_r$

Dims. in mm.

Ionisation inception level in isolated cases may be lower than admissible rated AC voltage.

Versions and dimensional drawings see page 120.

Part number completion:

Version codes see page 122.

Tolerance: 20 % = M

10 % = K

5 % = J

Packing: bulk = S

Pin length: 6-2 = SD

none = 00 (for plate versions)

Rights reserved to amend design data without prior notification.

Impedance change with frequency (general guide) (examples).

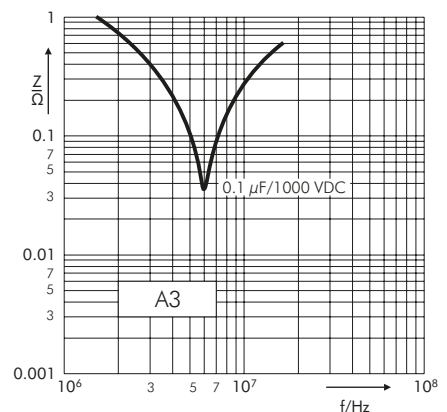
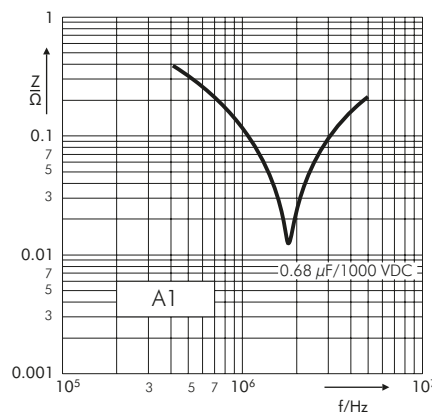

Continuation

Permissible AC voltage in relation to frequency at 10° C internal temperature rise (general guide).

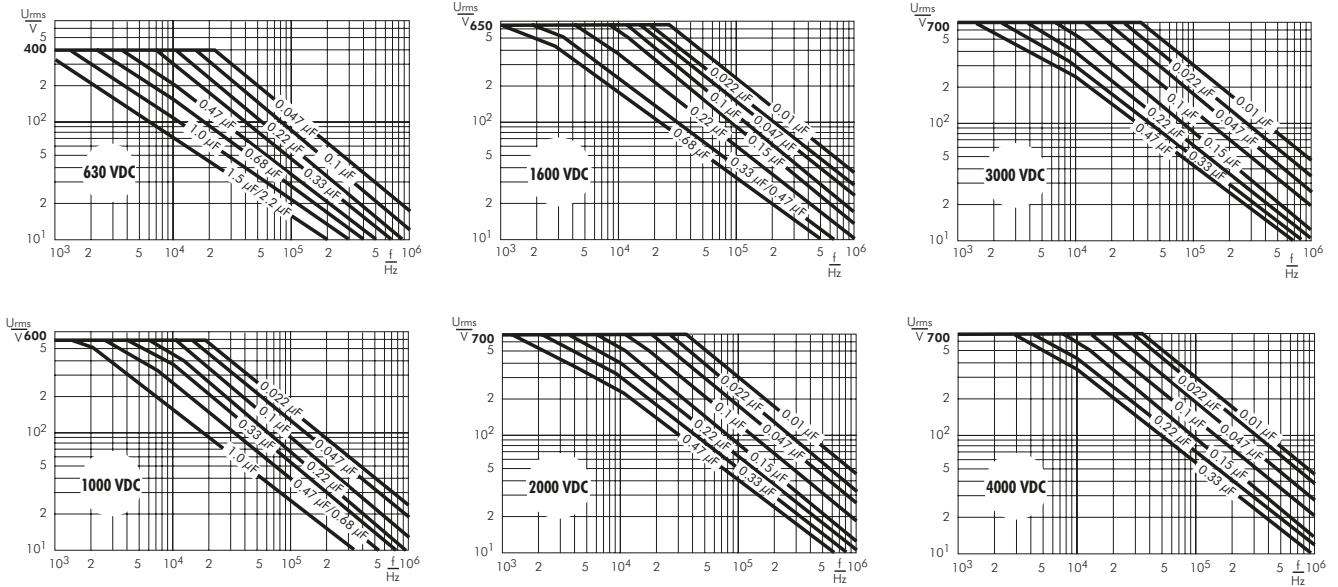

Versions of WIMA Snubber-Capacitors

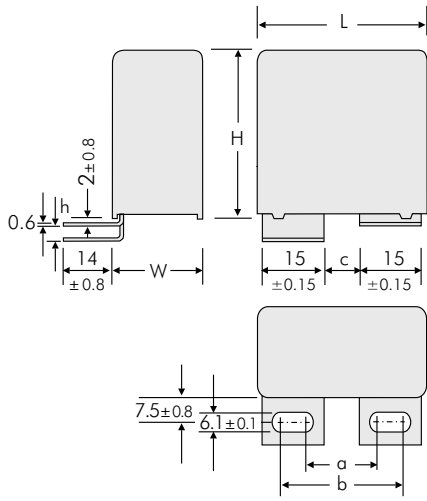

Version	L	a ±0.5	b ±0.5	c ±0.5	h ±0.8
A1	41.5	17.5	28	7.5	0
A1.5	41.5	17.5	28	7.5	3.5
A1	56	20	30	10	0
A1.1.1	56	28	38	18	0
A1.4.1	56	28	38	18	3.5

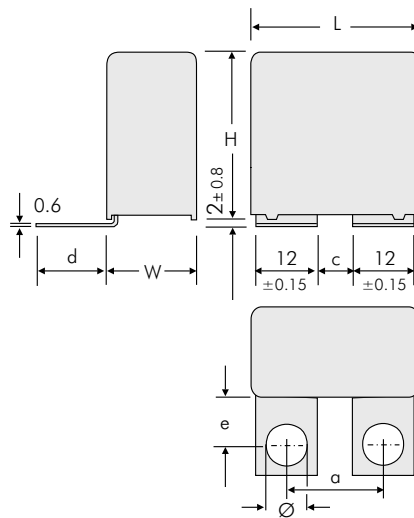

Version	L	a ±0.5	c ±0.5	d ±0.8	e ±0.8	Ø ±0.1
A1.6	41.5	18	6	21.5	16	7
A1.6.1	41.5	22	10	18.5	13	7
A1.6.2	41.5	23	10	18.5	13	8
A1.6	56	29	17	21.5	16	7

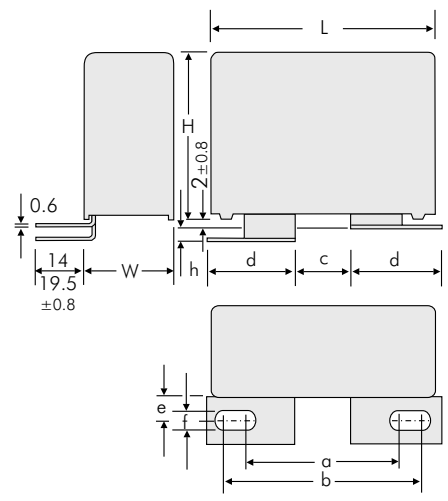

Version	L	a ±0.5	b ±0.5	c ±0.5	d ±0.15	e ±0.8	f ±0.1	h ±0.8
A2	41.5	36	46.5	14.5	22	7.5	8.4	0
A2.4.1	41.5	33.5	39.5	7.5	22	13	8.4	0
A2.6.1	41.5	31.5	41.5	14	22	13	6.1	3.5
A2.6.2	41.5	31.5	41.5	14	22	13	6.1	0
A2.8	41.5	36	46.5	14.5	22	7.5	8.4	3.5
A2.1	56	39.5	45.5	13.5	22	7.5	8.4	0
A2.1.2	56	36	45.5	14.5	21.5	7.5	8.4	0

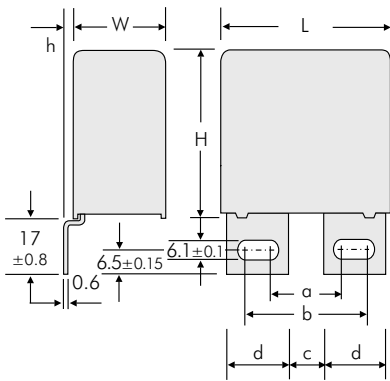

Version	L	a ±0.5	b ±0.5	c ±0.5	d ±0.15	h ±0.8
A3	41.5	17.5	27.5	7.5	15	0
A3.5	41.5	17.5	27.5	7.5	15	3
A3.12	41.5	17.5	30	7.5	16.5	0
A3	56	20	30	10	15	0
A3.1	56	28	38	18	15	0
A3.5	56	20	30	10	15	3
A3.10	56	28	38	18	15	3

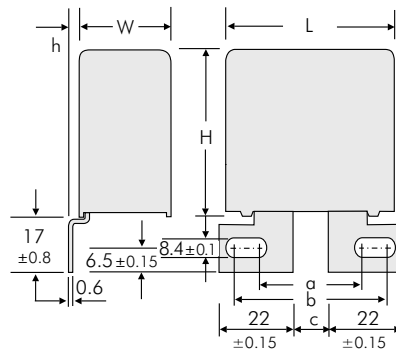

Version	L	a ±0.5	b ±0.5	c ±0.5	h ±0.8
A3.9	41.5	36	46.5	14.5	0
A3.11	41.5	36	46.5	14.5	3
A3.2	56	36	46.5	14.5	0
A3.3	56	36	46.5	14.5	3

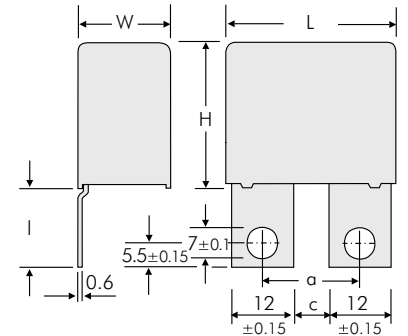

Version	L	a ±0.5	c ±0.5	l ±0.8
A3.8	41.5	18	6	23
A3.8.1	41.5	22	10	17.5
A3.8.2	41.5	22	10	23

Versions of WIMA Snubber-Capacitors

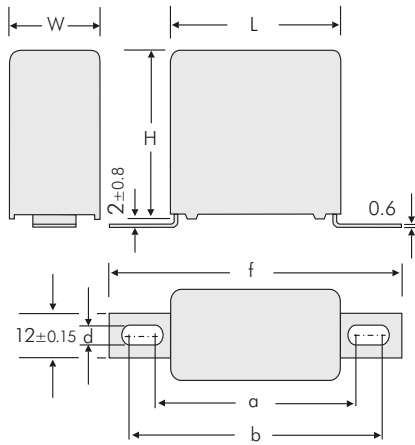

Version	L	a ±0.8	b ±0.8	f ±0.8	d ±0.1
A4.9	31.5 W ≥ 15	44	47	57	4.5
A4.10	31.5 W ≥ 15	43	59	69	6.1
A4.2	41.5 W ≥ 15	54	57	67	4.5
A4	41.5 W ≥ 15	53	69	79	6.1
A4.7	56	65	68	78	4.5
A4	56	64	80	90	6.1

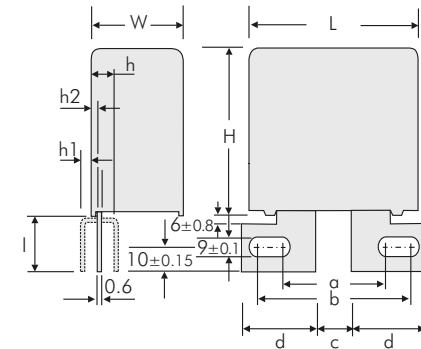

Version	W	a ±0.5	b ±0.5	c ±0.5	d ±0.15	h ±0.8	h1 ±0.8	h2 ±0.8	l ±0.8
A6	≥ 23	41.5	45.5	15.5	24.15	7	-	-	26
A6.3	≥ 19	35	39	18	19	-	5	3	25
A6.4	≥ 23	42.8	44.8	21	21.5	-	-	6.4	26

2-pin version

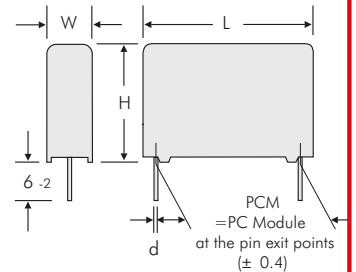

PCM	d
27.5	0.8
38.5	1.2
49.5	1.2

Dims. in mm

4-pin version

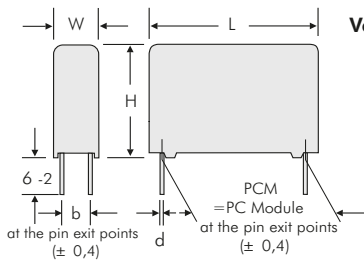

W	H	L	PCM	b	d
11	21	31.5	27.5	5	0.8
13	24	31.5	27.5	7.5	0.8
15	26	31.5	27.5	7.5	0.8
17	29	31.5	27.5	10	0.8
19	30	31.5	27.5	10	0.8
17	34.5	31.5	27.5	10	0.8
20	39.5	31.5	27.5	12.5	0.8
22	43.5	31.5	27.5	12.5	0.8
11	22	41.5	37.5	5	1
13	24	41.5	37.5	7.5	1
15	26	41.5	37.5	7.5	1
17	29	41.5	37.5	10	1
19	32	41.5	37.5	10	1
20	39.5	41.5	37.5	12.5	1
24	45.5	41.5	37.5	12.5	1
31	46	41.5	37.5	20	1
35	50	41.5	37.5	20	1
40	55	41.5	37.5	20	1
19	31	56	48.5	12.5	1
23	34	56	48.5	15	1
27	37.5	56	48.5	15	1
33	48	56	48.5	20	1
37	54	56	48.5	20	1

Version B

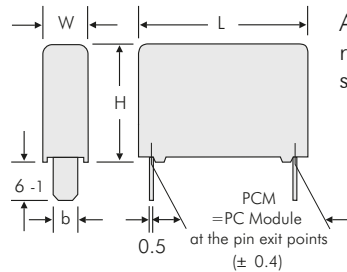

L	PCM	b ±0.15
31.5	28.5	8
41.5	38.5	8
56	49.5	8

Additional special versions can be realized. Please contact us with your specific needs.

Versions of WIMA Snubber-Capacitors



Version code		D2	D4	B8	1A	1B	1G	1H	1I	1J	1S	2A	2B	2Q	2F	2J	2K	2M	3A	3C	3D	3E	3G	3K	3L	3M	3N	3O	3P	3Q	4A	4C	4J	4L	4M	6A	6B	6C									
W x H x L	Size code	2-pin	4-pin	B8	A1	A1.1.1	A1.4.1	A1.5	A1.6	A1.6.1	A1.6.2	A2	A2.1	A2.1.2	A2.4.1	A2.6.1	A2.6.2	A2.8	A3	A3.1	A3.2	A3.3	A3.5	A3.8	A3.8.1	A3.8.2	A3.9	A3.10	A3.11	A3.12	A4	A4.2	A4.7	A4.9	A4.10	A6	A6.3	A6.4									
		11 x 21 x 31.5	6B																																												
13 x 24 x 31.5	6D																																														
15 x 26 x 31.5	6F																																														
17 x 29 x 31.5	6G																																														
17 x 34.5 x 31.5	6I																																														
11 x 22 x 41.5	7B																																														
13 x 24 x 41.5	7C																																														
15 x 26 x 41.5	7D																																														
17 x 29 x 41.5	7E																																														
19 x 32 x 41.5	7F																																														
20 x 39.5 x 41.5	7G																																														
24 x 45.5 x 41.5	7H																																														
31 x 46 x 41.5	7I																																														
35 x 50 x 41.5	7J																																														
40 x 55 x 41.5	7K																																														
19 x 31 x 56	8D																																														
23 x 34 x 56	8E																																														
27 x 37.5 x 56	8H																																														
33 x 48 x 56	8J																																														
37 x 54 x 56	8L																																														

Possible connecting respective plate versions - depending on box size.

■ 4-pin versions on request.

WIMA GTO Capacitors with Screw Connection for High Current Carrying Capability



WIMA GTO MKP

WIMA GTO MKP capacitors are especially designed to attenuate voltage spikes on GTO (Gate-Turn-Off) Thyristors and IGBT (Insulated Gate Bipolar Transistor). They are manufactured in dry-type technology with double-sided metallized electrodes and encapsulated in a cylindrical plastic case sealed with self-extinguishing polyurethane resin.

Their construction principle combined with the Polypropylene dielectric used creates outstanding features, e.g.:

- Very low self-inductance
- High pulse reliability

- High rms current carrying capability
- Very low dissipation factor
- Negative capacitance change versus temperature
- Excellent self-healing properties
- Outstanding mechanical stability
- High shock and vibration resistance
- Solvent-resistant, flame-retardant plastic case in accordance with UL 94 V-0
- Almost unlimited life expectancy

Fields of applications are designs where high current and voltage carrying capabilities are required, e.g. converter equipment in power generation or in traction technology for train drives, hoists, crane drives etc.

WIMA GTO MKP capacitors are available with capacitances from 1.0 μF through 100 μF and with nominal voltages from 400 VDC through 2000 VDC. For mounting purposes M6 and M8 threaded terminations are possible. Customer-specific requirements can be realized on demand.

All components are environmentally compatible with the RoHS 2015/863/EU regulations of the European Union.



GTO MKP Capacitors for Pulse Applications with Internal Series Connection. Capacitances from 1.0 μF to 100 μF . Rated Voltages from 400 VDC to 2000 VDC.

Special Features

- Pulse duty construction
- Self-healing
- Cylindrical capacitor body with axial screw and thread connections size M6 or M8
- Internal series connection from 400 VAC
- Very low dissipation factor
- Negative capacitance change versus temperature
- According to RoHS 2015/863/EU

Typical Applications

For high pulse and high frequency applications requiring extremely reliable contacts e.g.

- Damping of voltage spikes on GTO-Thyristors

Construction

Dielectric:

Polypropylene (PP) film

Capacitor electrodes:

Double-sided metallized plastic film

Internal construction:

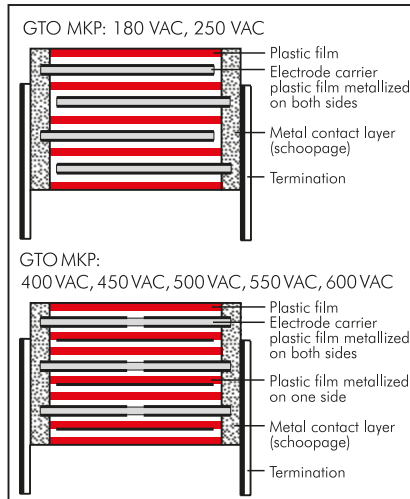

Encapsulation:

Solvent-resistant, flame-retardant plastic case with PU seal, UL 94 V-0

Terminations:

Axial screw connection M6 or M8.

Marking:

Colour: Red. Marking: Black on Silver.

Electrical Data

Capacitance range:

1.0 μF to 100 μF

Rated voltages:

400 VDC, 600 VDC, 850 VDC, 1000 VDC, 1200 VDC, 1500 VDC, 2000 VDC

Capacitance tolerances:

$\pm 20\%$, $\pm 10\%$, $\pm 5\%$

Operating temperature range:

-55°C to $+85^\circ\text{C}$

Climatic test category:

55/085/56 in accordance with IEC

Insulation resistance at $+20^\circ\text{C}$:

$\geq 10000 \text{ sec (M}\Omega \times \mu\text{F)}$

Measuring voltage: 100 V/1 min.

Test voltage:

$1.2 U_r$, 2 sec.

Dielectric absorption:

0.05%

Dissipation factors at $+20^\circ\text{C}$: $\tan \delta$

at f	$C \leq 20 \mu\text{F}$	$20 \mu\text{F} < C \leq 50 \mu\text{F}$	$C > 50 \mu\text{F}$
1 kHz	$\leq 3 \times 10^{-4}$	$\leq 5 \times 10^{-4}$	$\leq 8 \times 10^{-4}$

Voltage derating:

A voltage derating factor of 1.35 % per K must be applied from $+65^\circ\text{C}$ for DC voltages and from $+60^\circ\text{C}$ for AC voltages.

Reliability:

Operational life > 300000 hours

Failure rate $< 1 \text{ fit (} 0.5 \times U_r \text{ and } 40^\circ\text{C)}$

Specific dissipation:

Box size D x L in mm	Specific dissipation in Watts per K above the ambient temperature
60x49	0.186
70x49	0.231
80x49	0.280
90x49	0.333
90x58	0.364
90x97	0.501

Mounting Recommendation

Excessive mechanical strain, e.g. pressure or shock onto the capacitor body, is to be avoided during mounting and usage of the capacitors. When fixing the capacitor the screw torque is to be limited to max. 5 Nm.

For further details and graphs please refer to Technical Information.

Packing

Transportation-safe packing in cardboard boxes.

Packing units

D	pcs. per packing unit
60	12
70	8
80	6
90	6

Continuation

General Data

Capacitance	400 VDC/180 VAC*				600 VDC/250 VAC*			
	D x L mm	du/dt V/μsec	I _{max.} A	Part number	D x L mm	du/dt V/μsec	I _{max.} A	Part number
3.5 μF					60 x 49	200	770	GTOMI04350GA00
4 "					60 x 49	200	890	GTOMI04400GA00
4.5 "					60 x 49	200	990	GTOMI04450GA00
5 "					60 x 49	180	1090	GTOMI04500GA00
6 "					60 x 49	180	1310	GTOMI04600GA00
8 "					60 x 49	80	610	GTOMI04800GA00
10 μF					60 x 49	80	780	GTOMI05100GA00
15 "	60 x 49	50	790	GTOMG05150GA00	60 x 49	80	1150	GTOMI05150GA00
20 "	60 x 49	50	1050	GTOMG05200GA00	70 x 49	80	1540	GTOMI05200GB00
25 "	60 x 49	50	1330	GTOMG05250GA00	70 x 49	80	1940	GTOMI05250GB00
30 "	60 x 49	50	1610	GTOMG05300GA00	80 x 49	80	2340	GTOMI05300GC00
40 "	70 x 49	50	2090	GTOMG05400GB00	90 x 49	80	3080	GTOMI05400GD00
50 "	80 x 49	50	2680	GTOMG05500GC00	90 x 58	60	3050	GTOMI05500GE00
60 "	80 x 49	50	3240	GTOMG05600GC00	90 x 97	35	2140	GTOMI05600GF00
70 "	90 x 49	50	3630	GTOMG05700GD00	90 x 97	35	2520	GTOMI05700GF00
80 "	90 x 49	50	4100	GTOMG05800GD00	90 x 97	35	2810	GTOMI05800GF00
90 "	90 x 58	40	3800	GTOMG05900GE00	90 x 97	35	3200	GTOMI05900GF00
100 μF	90 x 58	40	4300	GTOMG06100GE00	90 x 97	35	3550	GTOMI06100GF00

Capacitance	850 VDC/400 VAC*				1000 VDC/450 VAC*			
	D x L mm	du/dt V/μsec	I _{max.} A	Part number	D x L mm	du/dt V/μsec	I _{max.} A	Part number
3 μF	60 x 49	200	770	GTOMM04300GA00	60 x 49	260	790	GTOMO14300GA00
3.5 "	60 x 49	200	770	GTOMM04350GA00	60 x 49	260	910	GTOMO14350GA00
4 "	60 x 49	200	890	GTOMM04400GA00	60 x 49	260	1050	GTOMO14400GA00
4.5 "	60 x 49	200	990	GTOMM04450GA00	60 x 49	260	1170	GTOMO14450GA00
5 "	60 x 49	200	1090	GTOMM04500GA00	60 x 49	260	1310	GTOMO14500GA00
6 "	60 x 49	200	1310	GTOMM04600GA00	60 x 49	260	1550	GTOMO14600GA00
8 "	60 x 49	200	1740	GTOMM04800GA00	70 x 49	260	2080	GTOMO14800GB00
10 μF	70 x 49	200	2190	GTOMM05100GB00	70 x 49	260	2600	GTOMO15100GB00
15 "	70 x 49	200	3230	GTOMM05150GB00	90 x 49	260	3920	GTOMO15150GD00
20 "	80 x 49	200	4310	GTOMM05200GC00	90 x 58	200	4300	GTOMO15200GE00
25 "	90 x 49	200	5390	GTOMM05250GD00	90 x 97	120	3050	GTOMO15250GF00
30 "	90 x 58	160	4800	GTOMM05300GE00	90 x 97	120	3580	GTOMO15300GF00
40 "	90 x 97	100	3780	GTOMM05400GF00	90 x 97	120	4770	GTOMO15400GF00
50 "	90 x 97	100	4790	GTOMM05500GF00				
60 "	90 x 97	100	5800	GTOMM05600GF00				

* AC voltage: $f \leq 1000 \text{ Hz}$; $1.4 \times U_{\text{rms}} + \text{UDC} \leq U_r$

Ionisation inception level in isolated cases may be lower than admissible rated AC voltage.

Part number completion:

Tolerance: 20 % = M
 10 % = K
 5 % = J
 Packing: bulk = S
 Pin length: none = 00

Rights reserved to amend design data without prior notification.

Continuation page 126

Continuation

General Data

Capacitance	1200 VDC/500 VAC*				1500 VDC/550 VAC*			
	D x L mm	du/dt V/μsec	I _{max.} A	Part number	D x L mm	du/dt V/μsec	I _{max.} A	Part number
1 μF					60 x 49	400	420	GTOMS04100GA00
1.5 "					60 x 49	400	590	GTOMS04150GA00
2 "					60 x 49	400	820	GTOMS04200GA00
2.5 "	60 x 49	300	770	GTOMQ04250GA00	60 x 49	400	1010	GTOMS04250GA00
3 "	60 x 49	300	950	GTOMQ04300GA00	60 x 49	400	1220	GTOMS04300GA00
3.5 "	60 x 49	300	1070	GTOMQ04350GA00	60 x 49	400	1400	GTOMS04350GA00
4 "	60 x 49	300	1230	GTOMQ04400GA00	70 x 49	400	1630	GTOMS04400GB00
4.5 "	60 x 49	300	1380	GTOMQ04450GA00	70 x 49	400	1800	GTOMS04450GB00
5 "	60 x 49	300	1570	GTOMQ04500GA00	70 x 49	400	2010	GTOMS04500GB00
6 "	70 x 49	300	1840	GTOMQ04600GB00	80 x 49	400	2390	GTOMS04600GC00
8 "	70 x 49	300	2470	GTOMQ04800GB00	90 x 49	400	3210	GTOMS04800GD00
10 μF	80 x 49	300	3080	GTOMQ05100GC00	90 x 58	320	3210	GTOMS05100GE00
15 "	90 x 58	230	3550	GTOMQ05150GE00	90 x 97	180	2690	GTOMS05150GF00
20 "	90 x 97	130	2690	GTOMQ05200GF00	90 x 97	180	3600	GTOMS05200GF00
25 "	90 x 97	130	3370	GTOMQ05250GF00				
30 "	90 x 97	130	4110	GTOMQ05300GF00				

Capacitance	2000 VDC/600 VAC*			
	D x L mm	du/dt V/μsec	I _{max.} A	Part number
1 μF	60 x 49	500	500	GTOMU04100GA00
1.5 "	60 x 49	500	750	GTOMU04150GA00
2 "	70 x 49	500	1000	GTOMU04200GB00
2.5 "	70 x 49	500	1250	GTOMU04250GB00
3 "	80 x 49	500	1500	GTOMU04300GC00
3.5 "	80 x 49	500	1750	GTOMU04350GC00
4 "	90 x 49	500	2000	GTOMU04400GD00
4.5 "	90 x 49	500	2250	GTOMU04450GD00
5 "	90 x 58	500	2500	GTOMU04500GE00
6 "	90 x 58	450	2700	GTOMU04600GE00
8 "	90 x 97	400	3200	GTOMU04800GF00
10 μF	90 x 97	300	3000	GTOMU05100GF00

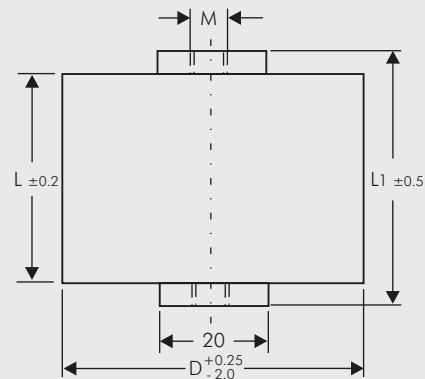

D	L	L1	M
60	49	55	M6
70	49	55	M6
80	49	55	M8
90	49	55	M8
90	58	64	M8
90	97	103	M8

* AC voltage: $f \leq 1000 \text{ Hz}$; $1.4 \times U_{\text{rms}} + \text{UDC} \leq U_{\text{r}}$

Ionisation inception level in isolated cases may be lower than admissible rated AC voltage.

Part number completion:	
Tolerance:	20 % = M
	10 % = K
	5 % = J
Packing:	bulk = S
Pin length:	none = 00

Rights reserved to amend design data without prior notification.

Continuation page 127

Continuation

Permissible AC voltage in relation to frequency at 20° C internal temperature rise (general guide).

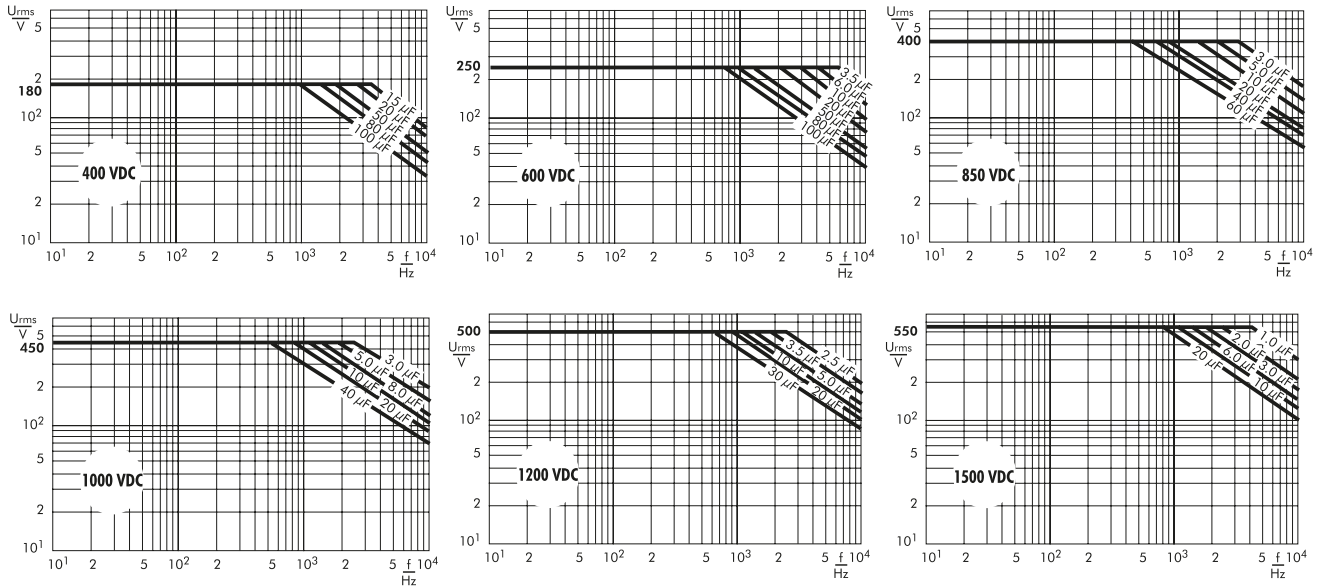

Permissible AC current in relation to frequency at 20° C internal temperature rise (general guide).

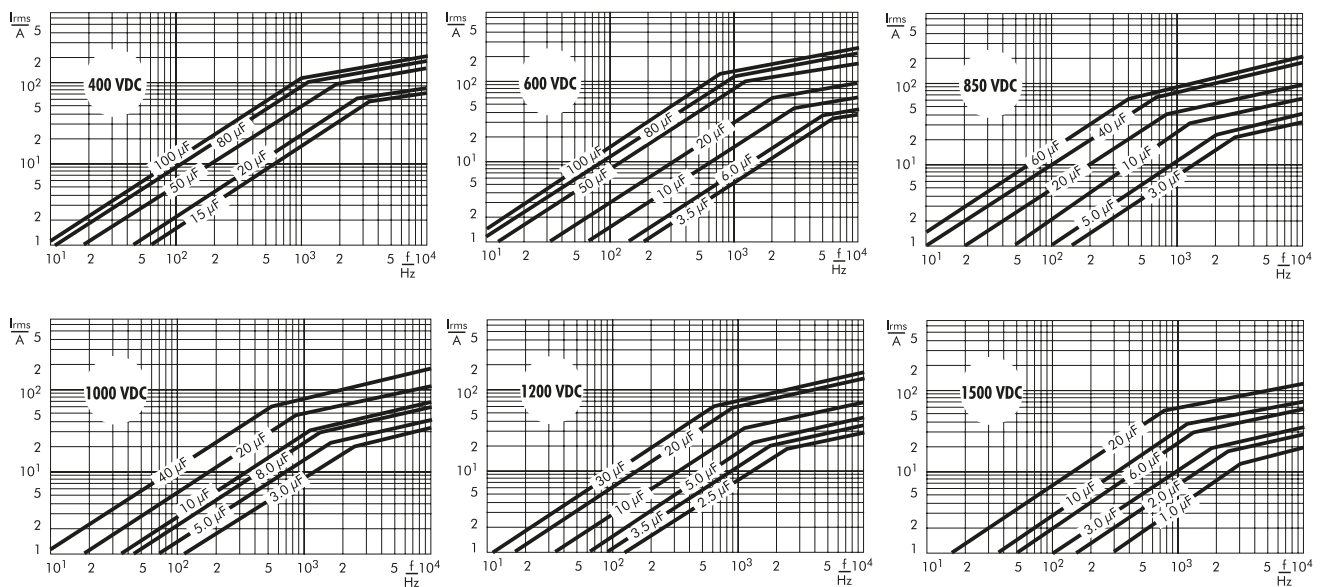

WIMA Intermediate Circuit Capacitors for Applications in High Power Converter Technology



- Particularly reliable contact configuration
- High shock and vibration resistance
- Outstanding mechanical stability

WIMA DC-LINK MKP 4 capacitors with rectangular case are available with capacitance values from 1 μF through 400 μF and with rated voltages from 400 VDC through 1300 VDC. For mounting purposes 2-pin, 4-pin or plate versions are possible.

WIMA DC-LINK MKP 6 capacitors have a cylindrical aluminium case. They are available with capacitances from 75 μF through 4920 μF and with rated voltages from 600 VDC through 1500 VDC. For bus bar mounting they are designed with male or female terminations and screw bolt. The WIMA DC-LINK MKP 6 HP series has been designed for stringent requirements.

Customized solutions can be realized on request with variable connecting configurations.

All components are environmentally compatible with the RoHS 2015/863/EU regulations of the European Union.

WIMA DC-LINK MKP 4

WIMA DC-LINK MKP 6

WIMA DC-LINK HC

CUSTOMIZED

WIMA DC-LINK capacitors are especially designed for applications in high power converter technology where they are more and more substituting electrolytic capacitors due to increasing electrical requirements. Manufactured with a low loss Polypropylene dielectric they show a higher current carrying capability as well as lower dissipation/self-heating at high frequencies compared to electrolytic capacitors. Further outstanding features are, e.g.:

- Very high capacitance/volume ratio
- High voltage rating per component
- Very low dissipation factor (ESR)
- Very high insulation resistance
- Excellent self-healing properties
- Long life expectancy
- Non-polar construction



WIMA DC-LINK MKP 4



Metallized Polypropylene (PP) - Capacitors for DC-Link Applications.
Capacitances from 1.0 µF to 400 µF.
Rated Voltages from 400 VDC to 1500 VDC.

Special Features

- Capacitances up to 400 µF
- High volume/capacitance ratio
- Excellent self-healing properties
- Very low dissipation factor
- High reliability
- 2-pin, 4-pin or plate contact configuration
- AEC-Q200 qualified
- According to RoHS 2015/863/EU

Typical Applications

As intermediate circuit capacitor e.g. in high power converter technology, power supplies, solar inverters, e-mobility (battery chargers, motor drives & power train) etc.

Construction

Dielectric:

Polypropylene (PP) film

Capacitor electrodes:

Vacuum-deposited

Internal construction:

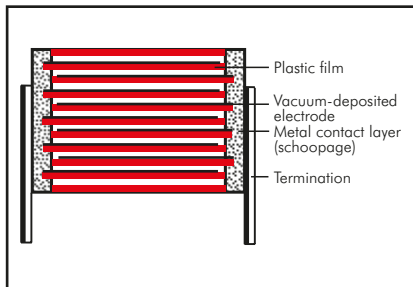

Encapsulation:

Solvent-resistant, flame-retardant plastic case with epoxy resin seal, UL 94 V-0

Terminations:

Tinned wire or plates.

Marking:

Colour: Red. Marking: Black.

Packing

Packing units at the end of the catalogue

Electrical Data

Capacitance range: 1 µF to 400 µF (intermediate values on request)

Rated voltages: 400VDC, 500VDC, 600VDC, 800VDC, 900VDC, 1100VDC, 1300VDC, 1500VDC

Capacitance tolerances: ±20%, ±10%, ±5%

Operating temperature range: -55° C to +105° C (hot spot including self-heating)

Climatic test category: 55/085/56 in accordance with IEC

Insulation resistance at +20° C: ≥ 30 000 sec (MΩ x µF)

Measuring voltage: 100 V/1 min.

Dielectric absorption: 0.05 %

Voltage and current derating:

A derating factor of 1.35% per K must be applied from +85° C for DC voltages and from +70° C for AC currents (I_{rms}). Additionally a derating factor of 4.5% per K must be applied from +85° C for AC currents (I_{rms})

Reliability: Operational life > 100 000 hours (U_r and 70° C)

Failure rate λ_0 (0.5 x U_r and 40° C)

$\Pi = C_N [\mu F] \times U_r [V] $	λ_0
$\Pi \leq 10\,000$	< 2 fit
$10\,000 < \Pi \leq 25\,000$	< 5 fit
$25\,000 < \Pi \leq 50\,000$	< 10 fit
$50\,000 < \Pi \leq 100\,000$	< 20 fit
$\Pi > 100\,000$	< 30 fit

Test voltage:

≤ 500 VDC: 1.5 U_r , 2sec

> 500 VDC: 1.2 U_r , 2sec

Specific dissipation:

Box size WxHxL in mm	Specific dissipation in Watts per K above the ambient temperature
9x19x31.5	0.021
11x21x31.5	0.025
13x24x31.5	0.030
15x26x31.5	0.034
17x29x31.5	0.039
17x34.5x31.5	0.044
20x39.5x31.5	0.053
13x24x41.5	0.037
15x26x41.5	0.042
17x29x41.5	0.048
19x32x41.5	0.054
20x39.5x41.5	0.065
24x45.5x41.5	0.080
28x38x41.5	0.076
31x46x41.5	0.092
35x50x41.5	0.106
40x55x41.5	0.123
25x45x57	0.102
30x45x57	0.113
35x50x57	0.132
45x55x57	0.164
45x65x57	0.184

For further details and graphs please refer to Technical Information.

Dissipation factors at +20° C: $\tan \delta \times 10^{-4}$

PCM	400VDC		500VDC		600VDC		800VDC		900VDC		1100VDC		1300VDC		1500VDC	
	1kHz	10kHz	1kHz	10kHz	1kHz	10kHz	1kHz	10kHz	1kHz	10kHz	1kHz	10kHz	1kHz	10kHz	1kHz	10kHz
27.5	15	160	15	130	12	120	10	90	10	80	10	60	7	50	7	40
37.5	60	350	30	240	21	150	18	170	16	150	14	100	12	90	12	90
52.5	80	550	80	460	40	300	35	250	31	200	30	170	23	150	23	150

Maximum pulse rise time:

PCM	max. pulse rise time V/µsec at $T_A < 40^\circ C$							
	400VDC	500VDC	600VDC	800VDC	900VDC	1100VDC	1300VDC	1500VDC
27.5	11	15	27	29	35	43	50	59
37.5	8	10	19	21	22	29	35	41
52.5	5	7	13	15	18	21	25	29

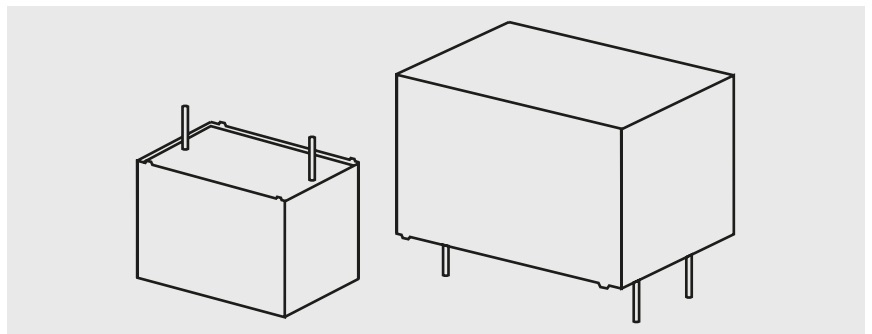



Continuation

General Data

Capacitance	400 VDC (70° C) / 300 VDC (85° C) / 220 VDC (105° C)								Part number
	W	H	L	PCM**	Pin	I _S A	I _{rms} * (10 kHz)* A	ESR (10 kHz)* mΩ	
1 µF	9	19	31.5	27.5	2	11	1	238.7	DCP4G041006A
2 "	9	19	31.5	27.5	2	22	1.5	119.4	DCP4G042006A
3 "	9	19	31.5	27.5	2	33	1.5	79.6	DCP4G043006A
4 "	9	19	31.5	27.5	2	44	2	59.7	DCP4G044006A
5 "	9	19	31.5	27.5	2	55	2	47.7	DCP4G045006A
7 "	9	19	31.5	27.5	2	77	2.5	34.1	DCP4G047006A
10 µF	11	21	31.5	27.5	2/4	110	3.5	23.9	DCP4G051006B
15 "	13	24	31.5	27.5	2/4	165	4.5	15.9	DCP4G051506D
20 "	15	26	31.5	27.5	2/4	220	5.5	11.9	DCP4G052006F
22 "	17	29	31.5	27.5	2/4	242	6	9.8	DCP4G052206G
25 "	17	29	31.5	27.5	2/4	275	7	8.6	DCP4G052506G
	15	26	41.5	37.5	2/4	200	6.5	10	DCP4G052507D
30 "	17	34.5	31.5	27.5	2/4	330	8	7.2	DCP4G053006I
	17	29	41.5	37.5	2/4	240	7.5	8.5	DCP4G053007E
40 "	20	39.5	31.5	27.5	2/4	440	10	5.4	DCP4G054006J
	19	32	41.5	37.5	2/4	320	9.5	6	DCP4G054007F
50 "	20	39.5	41.5	37.5	2/4	400	11	5.4	DCP4G055007G
60 "	20	39.5	41.5	37.5	2/4	480	11.5	4.8	DCP4G056007G
70 "	24	45.5	41.5	37.5	2/4	560	13	4.7	DCP4G057007H
80 "	24	45.5	41.5	37.5	2/4	640	14	4.1	DCP4G058007H
90 "	24	45.5	41.5	37.5	2/4	720	15	3.6	DCP4G059007H
	28	38	41.5	37.5	2/4	720	15	3.6	DCP4G059007L
100 µF	31	46	41.5	37.5	2/4	800	18	2.8	DCP4G061007I
120 "	31	46	41.5	37.5	2/4	960	20	2.3	DCP4G061207I
140 "	35	50	41.5	37.5	2/4	1120	22.5	2.1	DCP4G061407J
150 "	35	50	41.5	37.5	2/4	1200	23	2	DCP4G061507J
	25	45	57	52.5	4	750	20	2.6	DCP4G061509D
160 "	40	55	41.5	37.5	2/4	1280	24.5	2	DCP4G061607K
	25	45	57	52.5	4	800	21	2.3	DCP4G061609D
180 "	40	55	41.5	37.5	2/4	1440	26	1.8	DCP4G061807K
	30	45	57	52.5	4	900	23.5	2	DCP4G061809E
200 "	40	55	41.5	37.5	2/4	1600	27.5	1.6	DCP4G062007K
	30	45	57	52.5	4	1000	25	1.8	DCP4G062009E
220 "	35	50	57	52.5	4	1100	27	1.8	DCP4G062209F
250 "	45	55	57	52.5	4	1250	32	1.6	DCP4G062509H
270 "	45	55	57	52.5	4	1350	33.5	1.5	DCP4G062709H
300 "	45	55	57	52.5	4	1500	35	1.3	DCP4G063009H
330 "	45	65	57	52.5	4	1650	37	1.2	DCP4G063309J
350 "	45	65	57	52.5	4	1750	40	1.1	DCP4G063509J
370 "	45	65	57	52.5	4	1850	41.5	1.1	DCP4G063709J
400 "	45	65	57	52.5	4	2000	43	1	DCP4G064009J

* General guide

* Permissible I_{rms} at 10° C internal temperature rise (general guide)

** PCM = Printed circuit module = pin spacing

Dims. in mm.

Part number completion:

Version code:	2-pin	= D2
	4-pin	= D4
Tolerance:	20 %	= M
	10 %	= K
	5 %	= J
Packing:	bulk	= S
Pin length:	6-2	= SD
Taped version see page 157.		

Rights reserved to amend design data without prior notification.

Continuation page 131

Continuation

General Data

Capacitance	500 VDC (70° C) / 400 VDC (85° C) / 290 VDC (105° C)								
	W	H	L	PCM**	Pin	I _s A	I _{rms} * (10 kHz)* A	ESR (10 kHz)* mΩ	Part number
1 μF	9	19	31.5	27.5	2	15	1	238.7	DCP4H141006A
2 "	9	19	31.5	27.5	2	30	1.5	119.4	DCP4H142006A
3 "	9	19	31.5	27.5	2	45	1.5	79.6	DCP4H143006A
4 "	9	19	31.5	27.5	2	60	1.8	63.7	DCP4H144006A
5 "	9	19	31.5	27.5	2	75	2.5	47.7	DCP4H145006A
7 "	11	21	31.5	27.5	2/4	105	3	34.1	DCP4H147006B
8 "	13	24	31.5	27.5	2/4	120	3	29.8	DCP4H148006D
10 μF	13	24	31.5	27.5	2/4	150	4	23.9	DCP4H151006D
12 "	15	26	31.5	27.5	2/4	180	4	19.9	DCP4H151206F
15 "	17	29	31.5	27.5	2/4	225	5	15.9	DCP4H151506G
	15	26	41.5	37.5	2/4	150	4.3	22.3	DCP4H151507D
18 "	17	29	31.5	27.5	2/4	270	6	9.5	DCP4H151806G
20 "	17	34.5	31.5	27.5	2/4	300	6	11.9	DCP4H152006I
	17	29	41.5	37.5	2/4	200	5.4	16.8	DCP4H152007E
22 "	20	39.5	31.5	27.5	2/4	330	7	10.9	DCP4H152206J
25 "	20	39.5	31.5	27.5	2/4	375	7.5	9.5	DCP4H152506J
	19	32	41.5	37.5	2/4	250	6.3	13.4	DCP4H152507F
30 "	20	39.5	41.5	37.5	2/4	300	9	7.9	DCP4H153007G
35 "	20	39.5	41.5	37.5	2/4	350	8.5	9.1	DCP4H153507G
40 "	20	39.5	41.5	37.5	2/4	400	10	5.7	DCP4H154007G
50 "	24	45.5	41.5	37.5	2/4	500	13	4.8	DCP4H155007H
	28	38	41.5	37.5	2/4	500	13	4.8	DCP4H155007L
55 "	24	45.5	41.5	37.5	2/4	550	14	4	DCP4H155507H
	28	38	41.5	37.5	2/4	550	14	4	DCP4H155507L
60 "	31	46	41.5	37.5	2/4	600	14	4.7	DCP4H156007I
70 "	31	46	41.5	37.5	2/4	700	16.5	3.9	DCP4H157007I
80 "	31	46	41.5	37.5	2/4	800	17.5	3.4	DCP4H158007I
90 "	35	50	41.5	37.5	2/4	900	19	3	DCP4H159007J
100 μF	35	50	41.5	37.5	2/4	1000	20	2.7	DCP4H161007J
	25	45	57	52.5	4	700	14.3	5	DCP4H161009D
120 "	40	55	41.5	37.5	2/4	1200	22.5	2.7	DCP4H161207K
	30	45	57	52.5	4	840	16.5	4.2	DCP4H161209E
130 "	40	55	41.5	37.5	2/4	1300	23	2.4	DCP4H161307K
140 "	35	50	57	52.5	4	980	21.5	2.8	DCP4H161409F
150 "	35	50	57	52.5	4	1050	22.5	2.7	DCP4H161509F
160 "	45	55	57	52.5	4	1120	25.5	2.5	DCP4H161609H
180 "	45	55	57	52.5	4	1260	27	2.2	DCP4H161809H
200 "	45	55	57	52.5	4	1400	28.5	2	DCP4H162009H
210 "	45	55	57	52.5	4	1470	29.5	1.9	DCP4H162109H
220 "	45	65	57	52.5	4	1540	32	1.8	DCP4H162209J
240 "	45	65	57	52.5	4	1680	33.5	1.7	DCP4H162409J

* General guide

* Permissible I_{rms} at 10° C internal temperature rise (general guide)

** PCM = Printed circuit module = pin spacing

Dims. in mm.

Rights reserved to amend design data without prior notification.

Part number completion:	
Version code:	2-pin = D2
	4-pin = D4
Tolerance:	20 % = M
	10 % = K
	5 % = J
Packing:	bulk = S
Pin length:	6-2 = SD
Taped version see page 157.	

Continuation page 132

Continuation

General Data

Capacitance	600 VDC (70° C) / 450 VDC (85° C) / 320 VDC (105° C)								
	W	H	L	PCM**	Pin	I _S A	I _{rms} * (10 kHz)* A	ESR (10 kHz)* mΩ	Part number
1 μF	9	19	31.5	27.5	2	27	1.5	106.9	DCP4I041006A
2 "	9	19	31.5	27.5	2	54	2	56	DCP4I042006A
3 "	9	19	31.5	27.5	2	81	2.5	35.6	DCP4I043006A
4 "	11	21	31.5	27.5	2/4	108	3	26.7	DCP4I044006B
5 "	13	24	31.5	27.5	2/4	135	3.5	22	DCP4I045006D
7 "	15	26	31.5	27.5	2/4	189	4.5	16	DCP4I047006F
8 "	15	26	31.5	27.5	2/4	216	5	13.4	DCP4I048006F
10 μF	17	29	31.5	27.5	2/4	270	6	11	DCP4I051006G
	13	24	41.5	37.5	2/4	190	5	17.6	DCP4I051007C
12 "	17	29	31.5	27.5	2/4	324	6.5	8.9	DCP4I051206G
15 "	17	34.5	31.5	27.5	2/4	405	8	7	DCP4I051506I
	17	29	41.5	37.5	2/4	285	6.5	11.8	DCP4I051507E
18 "	20	39.5	31.5	27.5	2/2	486	9.5	5.9	DCP4I051806J
20 "	20	39.5	31.5	27.5	2/4	540	10	5.3	DCP4I052006J
	19	32	41.5	37.5	2/4	380	10.5	4.9	DCP4I052007F
22 "	20	39.5	41.5	37.5	2/4	418	11	5.4	DCP4I052207G
25 "	20	39.5	41.5	37.5	2/4	475	11.5	5	DCP4I052507G
30 "	24	45.5	41.5	37.5	2/4	570	14	4.1	DCP4I053007H
35 "	24	45.5	41.5	37.5	2/4	665	14.5	3.8	DCP4I053507H
	28	38	41.5	37.5	2/4	665	14.5	3.8	DCP4I053507L
40 "	31	46	41.5	37.5	2/4	760	16.5	3.3	DCP4I054007I
45 "	31	46	41.5	37.5	2/4	855	17	3.2	DCP4I054507I
50 "	35	50	41.5	37.5	2/4	950	19	2.9	DCP4I055007J
60 "	35	50	41.5	37.5	2/4	1140	17.5	3.4	DCP4I056007J
	25	45	57	52.5	2/4	780	14.5	4.9	DCP4I056009D
70 "	40	55	41.5	37.5	2/4	1330	20	3.1	DCP4I057007K
	30	45	57	52.5	4	910	16.5	4.2	DCP4I057009E
80 "	40	55	41.5	37.5	2/4	1520	22	2.6	DCP4I058007K
	30	45	57	52.5	4	1040	17.8	3.6	DCP4I058009E
90 "	35	50	57	52.5	4	1170	23.5	1.9	DCP4I059009F
100 μF	45	55	57	52.5	4	1300	25	2.6	DCP4I061009H
120 "	45	65	57	52.5	4	1560	28	2.3	DCP4I061209J
140 "	45	65	57	52.5	4	1820	31	1.9	DCP4I061409J
150 "	45	65	57	52.5	4	1950	33	1.7	DCP4I061509J

* General guide

* Permissible I_{rms} at 10° C internal temperature rise (general guide)

** PCM = Printed circuit module = pin spacing

Dims. in mm.

Part number completion:	
Version code:	2-pin = D2
	4-pin = D4
Tolerance:	20 % = M
	10 % = K
	5 % = J
Packing:	bulk = S
Pin length:	6-2 = SD
Taped version see page 157.	

2-pin version

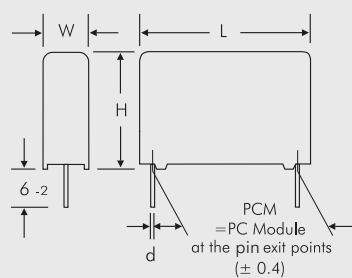

4-pin version

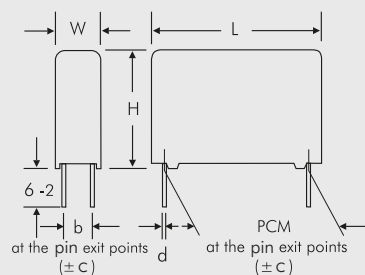

Rights reserved to amend design data without prior notification.

Continuation

General Data

Capacitance	800 VDC (70° C) / 700 VDC (85° C) / 510 VDC (105° C)					I_s A	I_{rms}^* (10 kHz)* A	ESR (10 kHz)* mΩ	Part number
	W	H	L	PCM**	Pin				
1 μF	9	19	31.5	27.5	2	29	1.7	73.2	DCP4L041006A
2 "	9	19	31.5	27.5	2	58	2.5	36.6	DCP4L042006A
3 "	11	21	31.5	27.5	2/4	87	3	24.4	DCP4L043006B
4 "	13	24	31.5	27.5	2/4	116	4	18.3	DCP4L044006D
5 "	13	24	31.5	27.5	2/4	145	4.5	14.6	DCP4L045006D
7 "	17	29	31.5	27.5	2/4	203	6	10.5	DCP4L047006G
8 "	17	29	31.5	27.5	2/4	232	6.5	9.2	DCP4L048006G
10 μF	17	34.5	31.5	27.5	2/4	290	8	7.3	DCP4L051006I
	17	29	41.5	37.5	2/4	210	7.5	8.5	DCP4L051007E
12 "	20	39.5	31.5	27.5	2/4	348	9.5	6.1	DCP4L051206J
15 "	20	39.5	31.5	27.5	2/4	435	10.5	4.9	DCP4L051506J
	19	32	41.5	37.5	2/4	315	8.5	7.5	DCP4L051507F
18 "	20	39.5	41.5	37.5	2/4	378	9.5	7.2	DCP4L051807G
20 "	20	39.5	41.5	37.5	2/4	420	10	6.2	DCP4L052007G
22 "	20	39.5	41.5	37.5	2/4	462	10.5	5.9	DCP4L052207G
25 "	24	45.5	41.5	37.5	2/4	525	12.5	5	DCP4L052507H
30 "	24	45.5	41.5	37.5	2/4	630	14	4.1	DCP4L053007H
	28	38	41.5	37.5	2/4	630	14	4.1	DCP4L053007L
35 "	31	46	41.5	37.5	2/4	735	15.5	3.8	DCP4L053507I
40 "	31	46	41.5	37.5	2/4	840	16.5	3.3	DCP4L054007I
45 "	35	50	41.5	37.5	2/4	945	17.5	3.4	DCP4L054507J
50 "	35	50	41.5	37.5	2/4	1050	19	3	DCP4L055007J
	25	45	57	52.5	4	750	18.5	3	DCP4L055009D
60 "	40	55	41.5	37.5	2/4	1260	21.5	2.7	DCP4L056007K
	30	45	57	52.5	4	900	20.5	2.7	DCP4L056009E
65 "	35	50	57	52.5	4	975	22.5	2.2	DCP4L056509F
70 "	45	55	57	52.5	4	1050	23.5	3	DCP4L057009H
75 "	45	55	57	52.5	4	1125	24	2.9	DCP4L057509H
80 "	45	55	57	52.5	4	1200	24.5	3	DCP4L058009H
90 "	45	65	57	52.5	4	1350	25.5	2.5	DCP4L059009J
100 μF	45	65	57	52.5	4	1500	26.5	2.3	DCP4L061009J
115 "	45	65	57	52.5	4	1725	28	2.1	DCP4L061159J

* General guide

* Permissible I_{rms} at 10° C internal temperature rise (general guide)

** PCM = Printed circuit module = pin spacing

Dims. in mm.

Part number completion:	
Version code:	2-pin = D2 4-pin = D4
Tolerance:	20 % = M 10 % = K 5 % = J
Packing:	bulk = S
Pin length:	6-2 = SD
Taped version see page 157.	

2-pin version

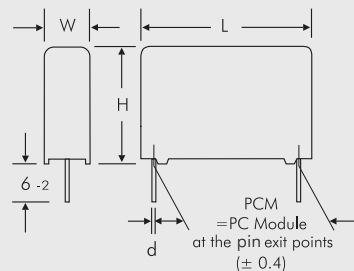

PCM	Ød
27.5	0.8
37.5	1

4-pin version

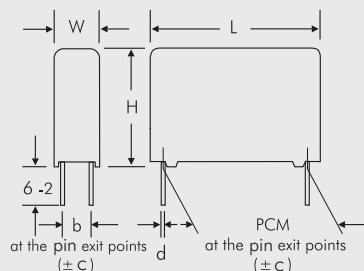

W	PCM	b	Ød	c
11	27.5	5	0.8	0.4
13	27.5	7.5	0.8	0.4
15	27.5	7.5	0.8	0.4
17	27.5	10	0.8	0.4
20	27.5	12.5	0.8	0.4
19	37.5	10	1	0.4
20	37.5	12.5	1	0.4
24	37.5	12.5	1	0.4
28	37.5	10	1	0.4
31	37.5	20	1	0.4
35	37.5	20	1	0.4
40	37.5	20	1	0.4
25	52.5	12.5	1.2	0.8
30	52.5	20	1.2	0.8
35	52.5	20	1.2	0.8
45	52.5	20	1.2	0.8

Rights reserved to amend design data without prior notification..

Continuation

General Data

Capacitance	900 VDC (70° C) / 760 VDC (85° C) / 550 VDC (105° C)								
	W	H	L	PCM**	Pin	I_S A	I_{rms}^* (10 kHz)* A	ESR (10 kHz)* mΩ	Part number
1 μF	9	19	31.5	27.5	2	35	2	66.1	DCP4N041006A_____
2 "	11	21	31.5	27.5	2/4	70	2.5	44	DCP4N042006B_____
3 "	13	24	31.5	27.5	2/4	105	4	22	DCP4N043006D_____
4 "	13	24	31.5	27.5	2/4	140	4.5	16.5	DCP4N044006D_____
5 "	17	29	31.5	27.5	2/4	175	4.5	18	DCP4N045006G_____
7 "	17	29	31.5	27.5	2/4	245	6.5	9.4	DCP4N047006G_____
8 "	17	34.5	31.5	27.5	2/4	280	7.5	8.3	DCP4N048006I_____
10 μF	20	39.5	31.5	27.5	2/4	350	10	5.3	DCP4N051006J_____
	19	32	41.5	37.5	2/4	220	9	6.7	DCP4N051007F_____
15 "	20	39.5	41.5	37.5	2/4	330	10.5	5.8	DCP4N051507G_____
20 "	24	45.5	41.5	37.5	2/4	440	13	4.8	DCP4N052007H_____
	28	38	41.5	37.5	2/4	440	13	4.8	DCP4N052007L_____
22 "	24	45.5	41.5	37.5	2/4	484	14	4.1	DCP4N052207H_____
	28	38	41.5	37.5	2/4	484	14	4.1	DCP4N052207L_____
25 "	31	46	41.5	37.5	2/4	550	15.5	3.8	DCP4N052507I_____
30 "	31	46	41.5	37.5	2/4	660	16.5	3.4	DCP4N053007I_____
	25	45	57	52.5	4	540	15	4.5	DCP4N053009D_____
35 "	35	50	41.5	37.5	2/4	770	18	3.2	DCP4N053507J_____
	25	45	57	52.5	4	630	16	4	DCP4N053509D_____
40 "	40	55	41.5	37.5	2/4	880	19.5	3.2	DCP4N054007K_____
	30	45	57	52.5	4	720	18	3.5	DCP4N054009E_____
50 "	35	50	57	52.5	4	900	22	3.3	DCP4N055009F_____
60 "	45	55	57	52.5	4	1080	23	3	DCP4N056009H_____
70 "	45	65	57	52.5	4	1260	24.5	3.3	DCP4N057009J_____
80 "	45	65	57	52.5	4	1440	25.5	2.8	DCP4N058009J_____

* General guide

* Permissible I_{rms} at 10° C internal temperature rise (general guide)

** PCM = Printed circuit module = pin spacing

Dims. in mm.

Part number completion:	
Version code:	2-pin = D2 4-pin = D4
Tolerance:	20 % = M 10 % = K 5 % = J
Packing:	bulk = S
Pin length:	6-2 = SD
Taped version see page 157.	

Rights reserved to amend design data without prior notification.

Continuation page 135

Continuation

General Data

Capacitance	1100 VDC (70° C) / 920 VDC (85° C) / 670 VDC (105° C)								
	W	H	L	PCM**	Pin	I _s A	I _{rms} * (10 kHz)* A	ESR (10 kHz)* mΩ	Part number
1 μF	9	19	31.5	27.5	2	43	2	86	DCP4P041006A
2 "	13	24	31.5	27.5	2/4	86	4	19	DCP4P042006D
3 "	15	26	31.5	27.5	2/4	129	5	13.6	DCP4P043006F
4 "	17	29	31.5	27.5	2/4	172	6	10.8	DCP4P044006G
5 "	17	34.5	31.5	27.5	2/4	215	7.5	7.8	DCP4P045006I
7 "	20	39.5	31.5	27.5	2/4	301	9	6.5	DCP4P047006J
	19	32	41.5	37.5	2/4	203	7.5	10	DCP4P047007F
8 "	20	39.5	41.5	37.5	2/4	232	8	10	DCP4P048007G
10 μF	20	39.5	41.5	37.5	2/4	290	9.5	7.2	DCP4P051007G
12 "	24	45.5	41.5	37.5	2/4	348	11	6.6	DCP4P051207H
15 "	24	45.5	41.5	37.5	2/4	435	12	5.6	DCP4P051507H
	28	38	41.5	37.5	2/4	435	12	5.6	DCP4P051507L
18 "	31	46	41.5	37.5	2/4	522	13.5	5	DCP4P051807I
20 "	35	50	41.5	37.5	2/4	580	15	4.7	DCP4P052007J
	25	45	57	52.5	4	420	14.5	4.9	DCP4P052009D
22 "	35	50	41.5	37.5	2/4	638	15.5	4.4	DCP4P052207J
	25	45	57	52.5	4	462	15	4.5	DCP4P052209D
25 "	40	55	41.5	37.5	2/4	725	16.5	4.6	DCP4P052507K
	30	45	57	52.5	4	525	16	4.4	DCP4P052509E
30 "	35	50	57	52.5	4	630	17.5	4.4	DCP4P053009F
35 "	35	50	57	52.5	4	735	18	4	DCP4P053509F
40 "	35	50	57	52.5	4	840	18	4.3	DCP4P054009F
45 "	45	55	57	52.5	4	945	20	4.1	DCP4P054509H
50 "	45	65	57	52.5	4	1050	21	4.1	DCP4P055009J
60 "	45	65	57	52.5	4	1260	23	3.5	DCP4P056009J

Capacitance	1300 VDC (70° C) / 1100 VDC (85° C) / 800 VDC (105° C)								
	W	H	L	PCM**	Pin	I _s A	I _{rms} * (10 kHz)* A	ESR (10 kHz)* mΩ	Part number
1 μF	11	21	31.5	27.5	2/4	50	2.5	40	DCP4R241006B
2 "	15	26	31.5	27.5	2/4	100	4.5	16.8	DCP4R242006F
3 "	17	29	31.5	27.5	2/4	150	6	10.8	DCP4R243006G
4 "	17	34.5	31.5	27.5	2/4	200	6.5	10.4	DCP4R244006I
5 "	20	39.5	31.5	27.5	2/4	250	7.5	9.4	DCP4R245006J
	19	32	41.5	37.5	2/4	175	7	11	DCP4R245007F
7 "	20	39.5	41.5	37.5	2/4	245	8	10	DCP4R247007G
8 "	24	45.5	41.5	37.5	2/4	280	9	9.9	DCP4R248007H
10 μF	24	45.5	41.5	37.5	2/4	350	10.5	7.2	DCP4R251007H
	28	38	41.5	37.5	2/4	350	10.5	7.2	DCP4R251007L
15 "	31	46	41.5	37.5	2/4	525	14	4.8	DCP4R251507I
	25	45	57	52.5	4	375	13	6	DCP4R251509D
18 "	35	50	41.5	37.5	2/4	630	15.5	4.4	DCP4R251807J
	25	45	57	52.5	4	450	14.5	4.9	DCP4R251809D
20 "	40	55	41.5	37.5	2/4	700	17.5	4	DCP4R252007K
	30	45	57	52.5	4	500	16	4.4	DCP4R252009E
22 "	40	55	41.5	37.5	2/4	770	18	3.8	DCP4R252207K
	35	50	57	52.5	4	550	17.5	4.3	DCP4R252209F
25 "	35	50	57	52.5	4	625	19	3.6	DCP4R252509F
30 "	45	55	57	52.5	4	750	20	4	DCP4R253009H
35 "	45	65	57	52.5	4	875	21	4.1	DCP4R253509J
40 "	45	65	57	52.5	4	1000	22	3.7	DCP4R254009J

* General guide

** PCM = Printed circuit module = pin spacing

* Permissible I_{rms} at 10° C internal temperature rise (general guide)

Dims. in mm.

Rights reserved to amend design data without prior notification.

Continuation

General Data

Capacitance	1500 VDC (70° C) / 1200 VDC (85° C) / 870 VDC (105° C)								Part number
	W	H	L	PCM**	Pin	I_s A	I_{rms}^* (10 kHz)* A	ESR (10 kHz)* mΩ	
1 μF	13	24	31.5	27.5	2/4	59	3	33.3	DCP4S041006D
2 "	17	29	31.5	27.5	2/4	118	5	15.6	DCP4S042006G
3 "	19	32	41.5	37.5	2/4	123	6	15	DCP4S043007F
4 "	20	39.5	41.5	37.5	2/4	164	7	13.3	DCP4S044007G
5 "	20	39.5	41.5	37.5	2/4	205	8	10.2	DCP4S045007G
7 "	24	45.5	41.5	37.5	2/4	287	9.5	8.9	DCP4S047007H
	28	38	41.5	37.5	2/4	287	9.5	8.4	DCP4S047007L
8 "	31	46	41.5	37.5	2/4	328	11	7.6	DCP4S048007I
10 μF	31	46	41.5	37.5	2/4	410	12.5	5.9	DCP4S051007I
12 "	35	50	41.5	37.5	2/4	492	14.5	5	DCP4S051207J
	25	45	57	52.5	4	348	14	5.2	DCP4S051209D
15 "	40	55	41.5	37.5	2/4	615	17	4.3	DCP4S051507K
	30	45	57	52.5	4	435	16	4.4	DCP4S051509E
18 "	35	50	57	52.5	4	522	17.5	4.3	DCP4S051809F
20 "	35	50	57	52.5	4	580	18	4.1	DCP4S052009F
22 "	45	55	57	52.5	4	638	20	4.1	DCP4S052209H
25 "	45	55	57	52.5	4	725	20.5	3.9	DCP4S052509H
30 "	45	65	57	52.5	4	870	21.5	4	DCP4S053009J

* General guide

* Permissible I_{rms} at 10° C internal temperature rise (general guide)

** PCM = Printed circuit module = pin spacing

Dims. in mm.

Part number completion:	
Version code:	2-pin = D2
	4-pin = D4
Tolerance:	20 % = M
	10 % = K
	5 % = J
Packing:	bulk = S
Pin length:	6-2 = SD
Taped version see page 157.	

2-pin version

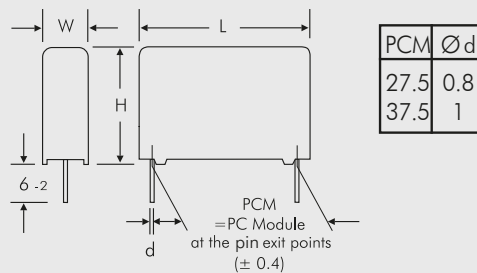

4-pin version

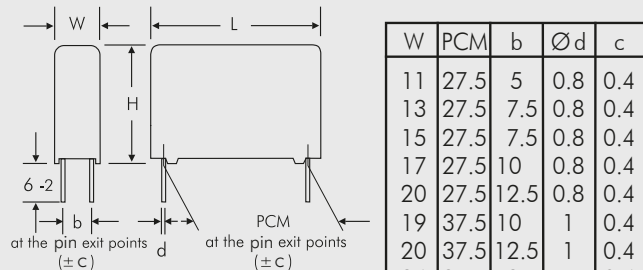
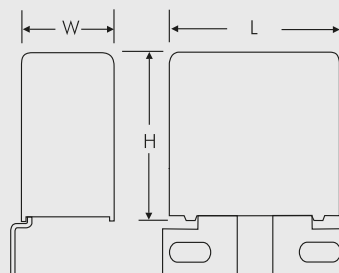

Plate versions page 140



Example

Rights reserved to amend design data without prior notification.

Continuation page 137

Continuation

500 VDC

Impedance change with frequency
(general guide)

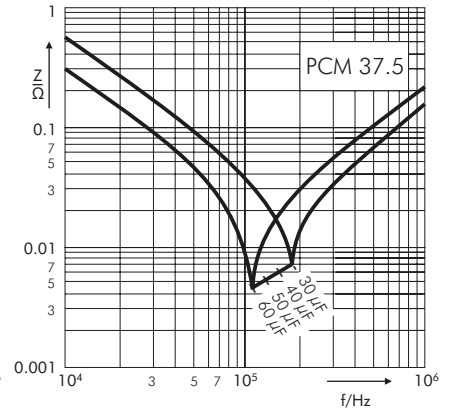
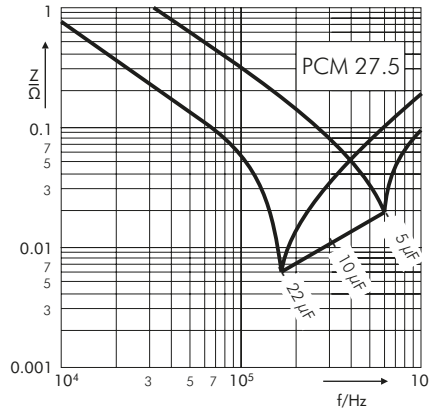

Permissible AC current in relation to
frequency at $\leq 20^\circ\text{C}$ internal temperature
rise (general guide)

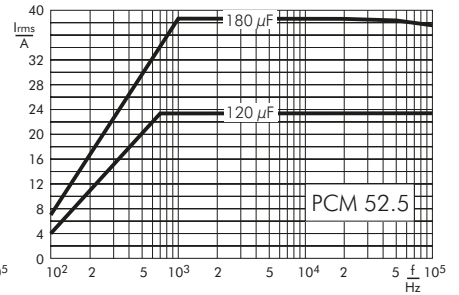
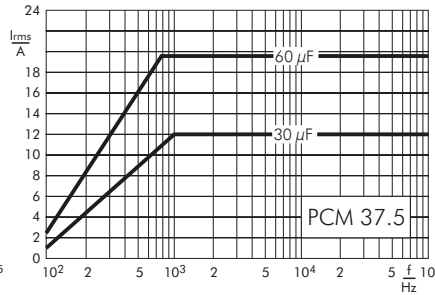
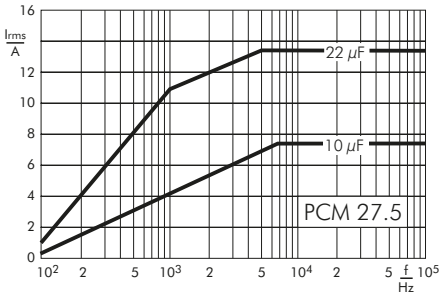

600 VDC

Impedance change with frequency
(general guide)

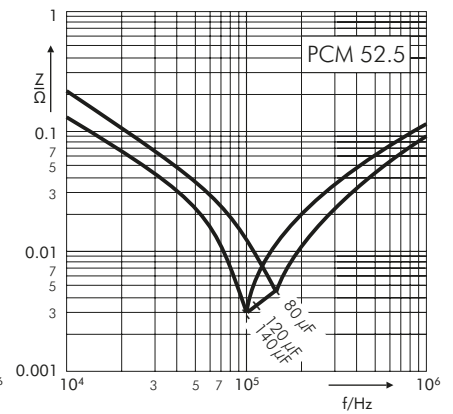
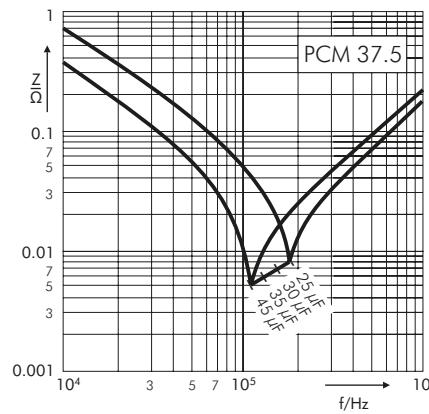

Permissible AC current in relation to
frequency at $\leq 20^\circ\text{C}$ internal temperature
rise (general guide)

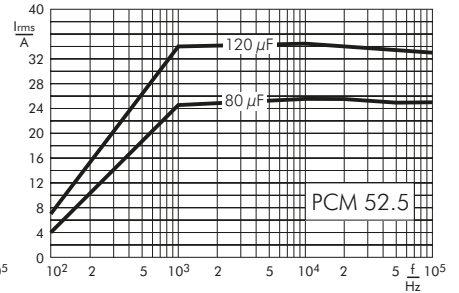
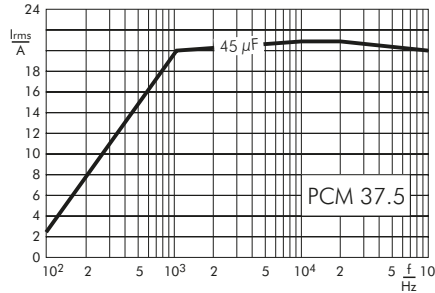

Continuation

800 VDC

Impedance change with frequency (general guide)

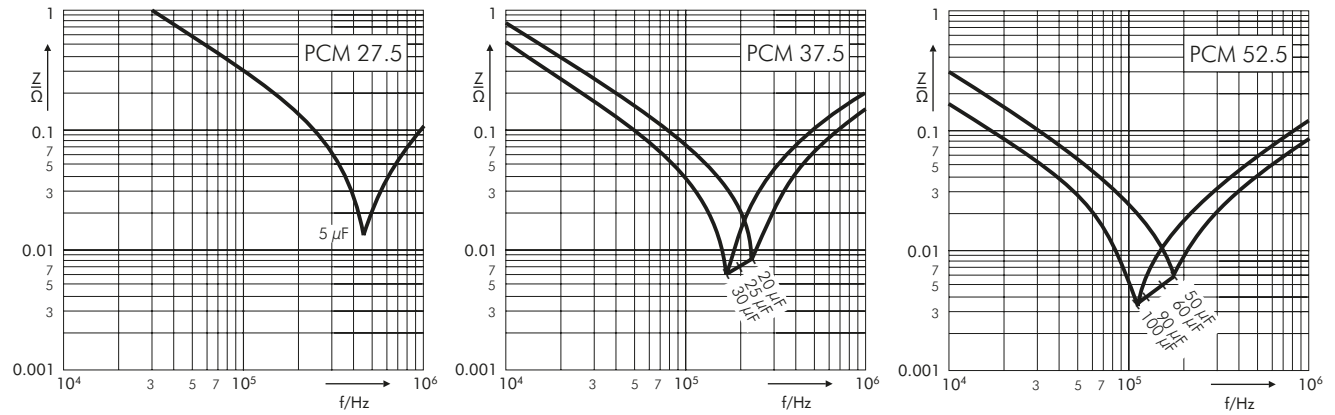

Permissible AC current in relation to frequency at $\leq 20^\circ\text{C}$ internal temperature rise (general guide)

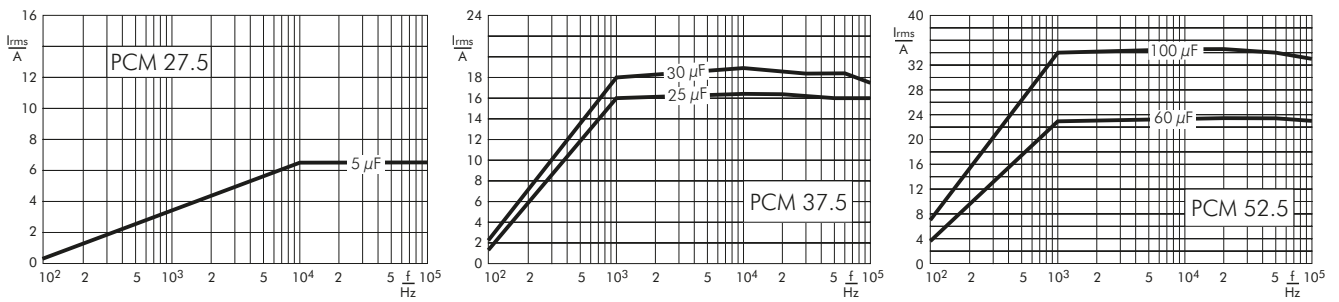

900 VDC

Impedance change with frequency (general guide)

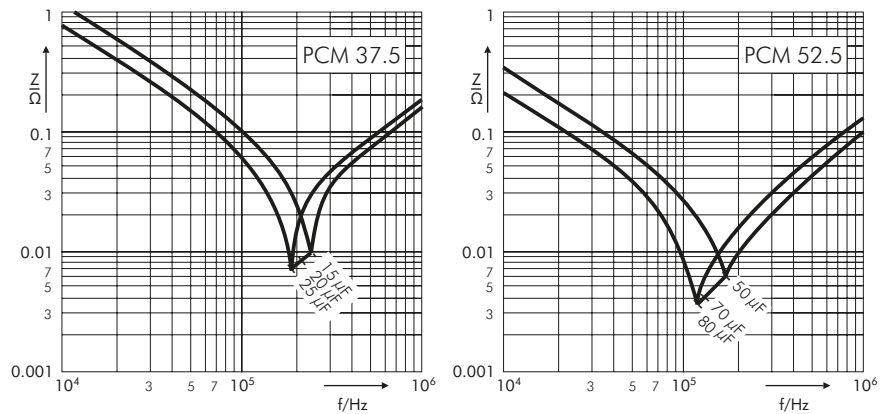

Permissible AC current in relation to frequency at $\leq 20^\circ\text{C}$ internal temperature rise (general guide)

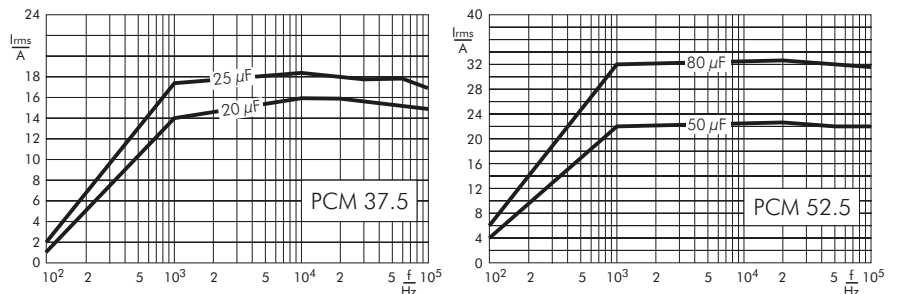

Continuation

1100 VDC

Impedance change with frequency (general guide)

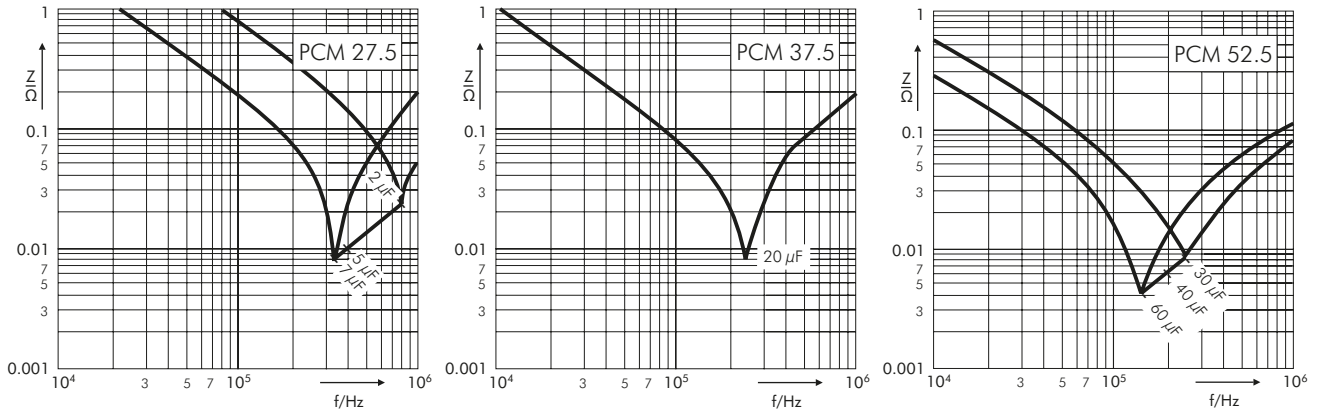

Permissible AC current in relation to frequency at $\leq 20^\circ\text{C}$ internal temperature rise (general guide)

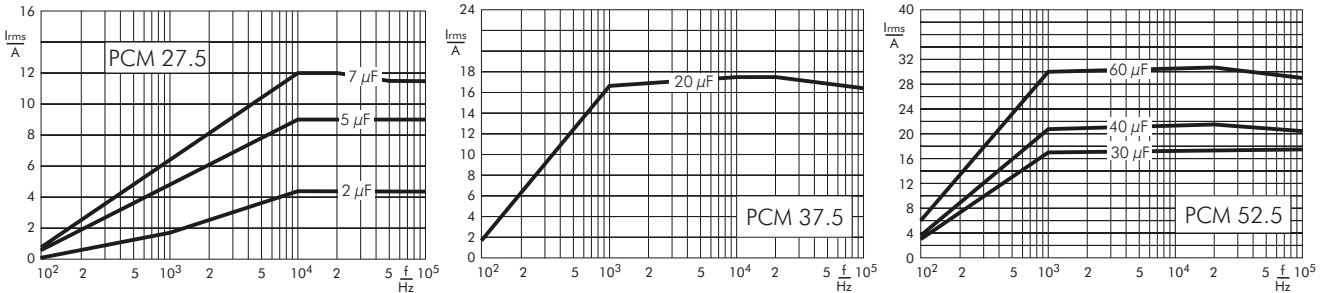

1300 VDC

Impedance change with frequency (general guide)

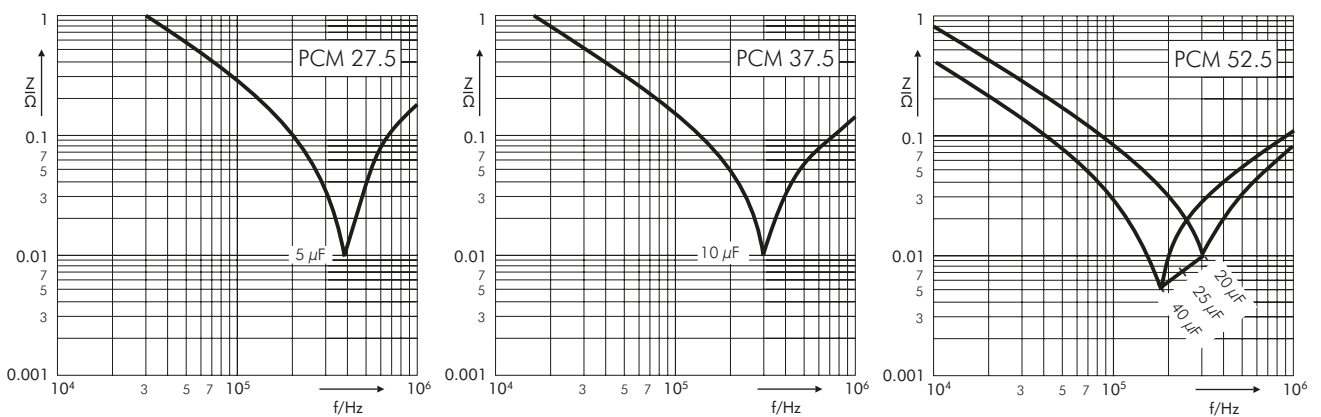

Permissible AC current in relation to frequency at $\leq 20^\circ\text{C}$ internal temperature rise (general guide)

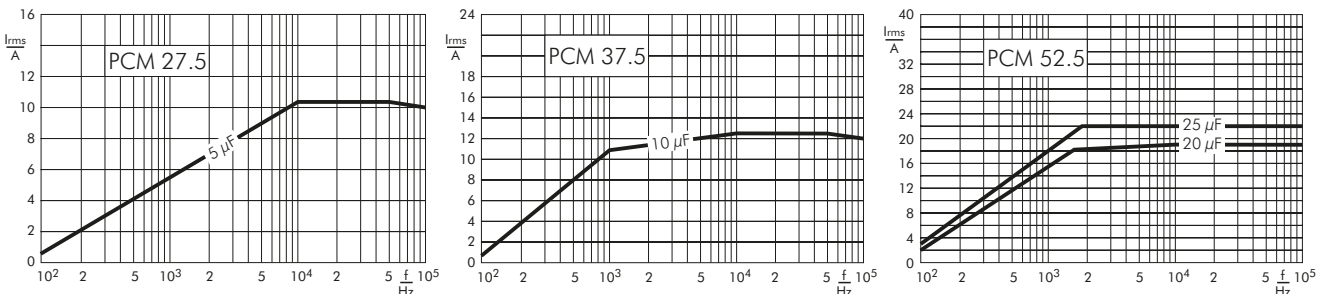

Continuation

Plate versions

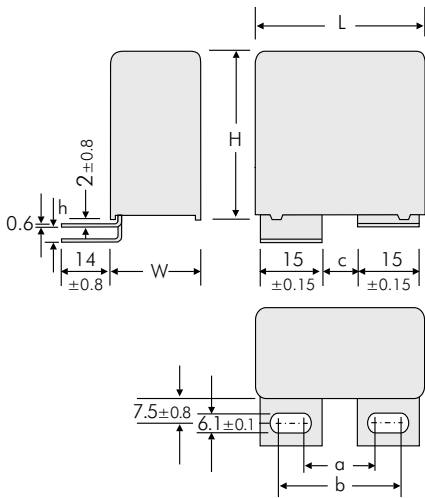

Version	L	a ±0.5	b ±0.5	c ±0.5	h ±0.8
A1	41.5	17.5	28	7.5	0
A1.5	41.5	17.5	28	7.5	3.5

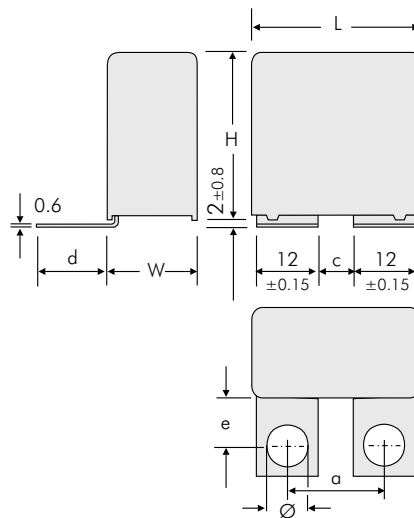

Version	L	a ±0.5	c ±0.5	d ±0.8	e ±0.8	Ø ±0.1
A1.6	41.5	18	6	21.5	16	7
A1.6.1	41.5	22	10	18.5	13	7
A1.6.2	41.5	23	10	18.5	13	8

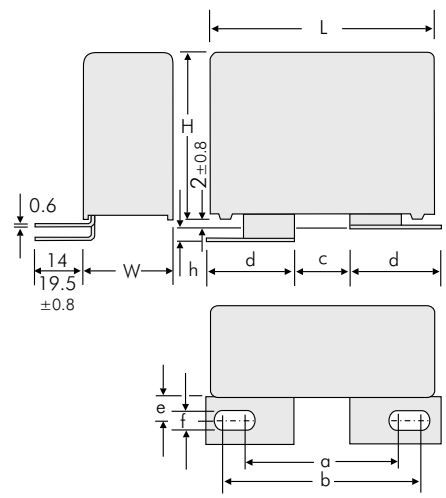

Version	L	a ±0.5	b ±0.5	c ±0.5	d ±0.15	e ±0.8	f ±0.1	h ±0.8
A2	41.5	36	46.5	14.5	22	7.5	8.4	0
A2.4.1	41.5	33.5	39.5	7.5	22	13	8.4	0
A2.6.1	41.5	31.5	41.5	14	22	13	6.1	3.5
A2.6.2	41.5	31.5	41.5	14	22	13	6.1	0
A2.8	41.5	36	46.5	14.5	22	7.5	8.4	3.5

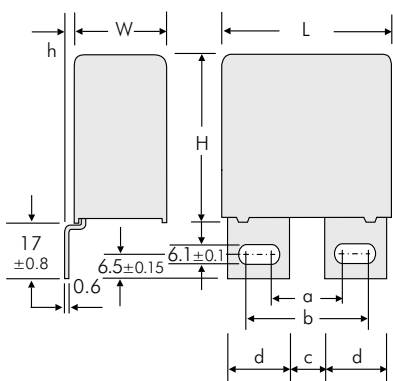

Version	L	a ±0.5	b ±0.5	c ±0.5	d ±0.15	h ±0.8
A3	41.5	17.5	27.5	7.5	15	0
A3.5	41.5	17.5	27.5	7.5	15	3
A3.12	41.5	17.5	30	7.5	16.5	0

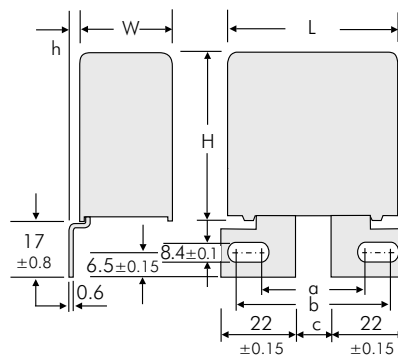

Version	L	a ±0.5	b ±0.5	c ±0.5	h ±0.8
A3.9	41.5	40.5	46.5	14.5	0
A3.11	41.5	40.5	46.5	14.5	3

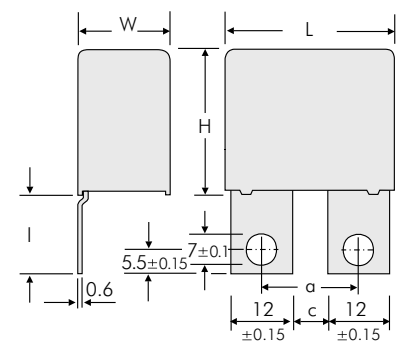

Version	L	a ±0.5	c ±0.5	l ±0.8
A3.8	41.5	18	6	23
A3.8.1	41.5	22	10	17.5
A3.8.2	41.5	22	10	23

Continuation

Plate versions

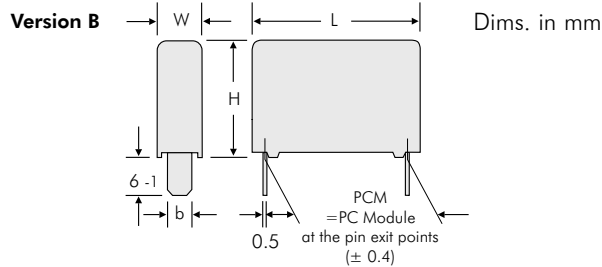
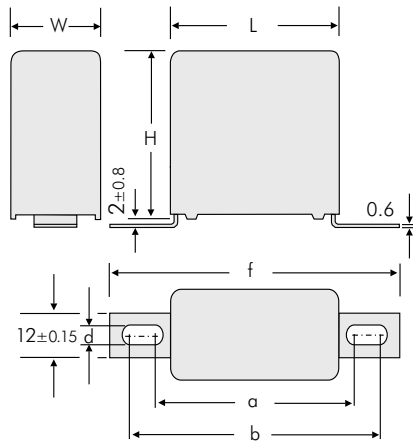

L	PCM	b ±0.15
31.5	28.5	8
41.5	38.5	8

Version	L	a ±0.8	b ±0.8	f ±0.8	d ±0.1
A4.9	31.5 W ≥ 15	44	47	57	4.5
A4.10	31.5 W ≥ 15	43	59	69	6.1
A4.2	41.5 W ≥ 15	54	57	67	4.5
A4	41.5 W ≥ 15	53	69	79	6.1

Additional special versions can be realized. Please contact us with your specific needs.

Possible connecting respective plate versions - depending on box size

Version code		D2	D4	B8	1A	1H	1I	1J	1S	2A	2F	2J	2K	2M	3A	3G	3K	3L	3M	3N	3P	3Q	4A	4C	4L	4M
W x H x L	Size Code	2-pin	4-pin	B8	A1	A1.5	A1.6	A1.6.1	A1.6.2	A2	A2.4.1	A2.6.1	A2.6.2	A2.8	A3	A3.5	A3.8	A3.8.1	A3.8.2	A3.9	A3.11	A3.12	A4	A4.2	A4.9	A4.10
9 x 19 x 31.5	6A																									
11 x 21 x 31.5	6B																									
13 x 24 x 31.5	6D																									
15 x 26 x 31.5	6F																									
17 x 29 x 31.5	6G																									
17 x 34.5 x 31.5	6I																									
20 x 39.5 x 31.5	6J																									
13 x 24 x 41.5	7C																									
15 x 26 x 41.5	7D																									
17 x 29 x 41.5	7E																									
19 x 32 x 41.5	7F																									
20 x 39.5 x 41.5	7G																									
24 x 45.5 x 41.5	7H																									
28 x 38 x 41.5	7L																									
31 x 46 x 41.5	7I																									
35 x 50 x 41.5	7J																									
40 x 55 x 41.5	7K																									

**Metallized Polypropylene (PP) - Capacitors in Cylindrical Case.
MKP 6 with High Volume/Capacitance Ratio, MKP 6 HP with Higher Current Carrying
Capability. Capacitances from 75 μF to 4920 μF . Rated Voltages from 600 VDC to 1500 VDC.**

Special Features

- Very high volume/capacitance ratio
- Self-healing properties
- With cylindrical aluminium case for bus bar mounting
- Dry construction without electrolyte or oil
- No internal fuse required
- Negative capacitance change versus temperature
- Very low dielectric absorption
- According to RoHS 2015/863/EU
- Customer-specific capacitances or voltages on request

Typical Applications

DC capacitors with high capacitances for applications in power electronics also at non-sinusoidal voltages and currents e.g. in

- Wind power systems
- Inverters

Construction

Dielectric:

Polypropylene (PP) film

Capacitor electrodes:

Vacuum-deposited

Internal construction:

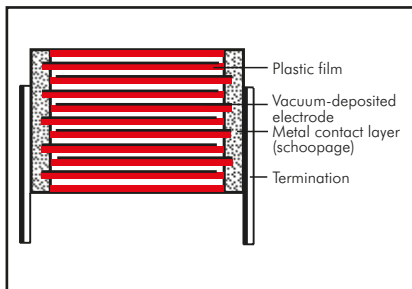

Encapsulation:

Aluminium case with PU-sealing, UL 94 V-0

Terminations:

Screw connection (male or female), screw bolt M12 x 16.

Marking:

Colour: Metallic. Marking: Black on silver label.

Electrical Data

Capacitance range: 75 μF to 4920 μF

Rated voltages: 600 VDC, 700 VDC, 900 VDC, 1100 VDC, 1300 VDC, 1500 VDC

Capacitance tolerances: $\pm 20\%$, $\pm 10\%$ ($\pm 5\%$ available subject to special enquiry)

Operating temperature range:

-40°C to $+85^\circ\text{C}$

Insulation resistance at $+20^\circ\text{C}$:

≥ 5000 sec ($\text{M}\Omega \times \mu\text{F}$)

Measuring voltage: 100 V/1 min.

Dielectric loss factor $\tan \delta_0$: 2×10^{-4}

Test voltage between terminals

at $+25^\circ\text{C}$: $1.5 U_{r\text{DC}}$, 10sec

Test voltage between terminals and case

at $+25^\circ\text{C}$ and 50 Hz: $3 kV_{AC}$, 1 min.

Dielectric absorption:

0.05 %

Reliability:

Operational life > 100000 hours

Failure rate < 50 fit (hot spot $\leq 70^\circ\text{C}$)

Mounting Recommendation

Excessive mechanical strain, e.g. pressure or shock onto the capacitor body, is to be avoided during mounting and usage of the capacitors.

Packing

Transportation-safe packing in cardboard boxes.

For further details and graphs please refer to Technical Information.

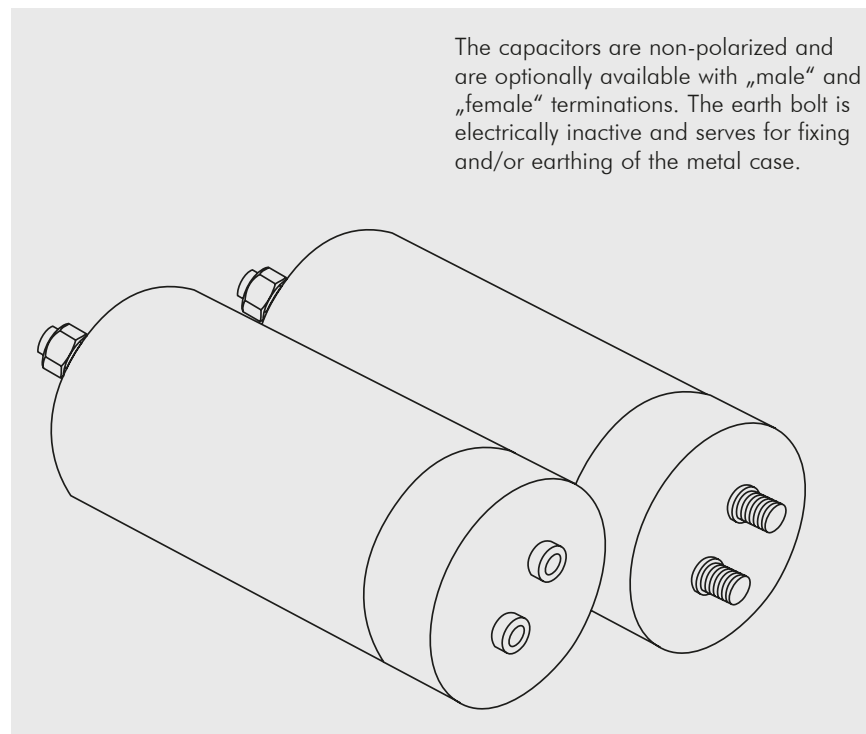

Continuation

General Data

U_R		C_N	D x L mm	I_{rms} (max.)* at 70° C A	ESR (1 kHz)* mΩ	L_e nH	Approx. weight g	Part number
70° C	85° C							
600 VDC	450 VDC	320 μF	85 x 60	25	2.1	< 40	380	DCP6I06320EB00
		460 "	85 x 76	25	2.1	< 40	480	DCP6I06460EC00
		520 "	85 x 85	30	2.0	< 40	540	DCP6I06520ED00
		620 "	85 x 95	30	1.9	< 40	600	DCP6I06620EE00
		760 "	85 x 110	30	1.7	< 40	690	DCP6I06760EF00
		780 "	85 x 120	30	1.7	< 40	700	DCP6I06780E000
		950 "	85 x 132	35	1.8	< 40	850	DCP6I06950E100
		1030 "	85 x 140	35	1.8	< 40	880	DCP6I07103EG00
		1220 "	116 x 95	40	1.7	< 40	1200	DCP6I07122EN00
		1500 "	116 x 110	40	1.7	< 40	1390	DCP6I07150EO00
		1640 "	116 x 120	40	1.6	< 40	1510	DCP6I07164EP00
		1890 "	116 x 132	40	1.6	< 40	1660	DCP6I07189EQ00
		2030 "	116 x 140	40	1.6	< 40	1760	DCP6I07203ER00
700 VDC	600 VDC	230 μF	85 x 60	25	1.9	< 40	380	DCP6K06230EB00
		330 "	85 x 76	25	1.9	< 40	480	DCP6K06330EC00
		380 "	85 x 85	30	1.7	< 40	540	DCP6K06380ED00
		450 "	85 x 95	30	1.7	< 40	600	DCP6K06450EE00
		550 "	85 x 110	30	1.8	< 40	690	DCP6K06550EF00
		585 "	85 x 120	30	1.8	< 40	700	DCP6K06585E000
		690 "	85 x 132	35	1.8	< 40	850	DCP6K06690E100
		740 "	85 x 140	35	1.8	< 40	880	DCP6K06740EG00
		890 "	116 x 95	40	1.7	< 40	1200	DCP6K06890EN00
		1090 "	116 x 110	40	1.7	< 40	1390	DCP6K07109EO00
		1190 "	116 x 120	40	1.8	< 40	1510	DCP6K07119EP00
		1370 "	116 x 132	40	1.8	< 40	1660	DCP6K07137EQ00
		1470 "	116 x 140	40	1.8	< 40	1760	DCP6K07147ER00
900 VDC	760 VDC	190 μF	85 x 60	30	1.9	< 40	380	DCP6N06190EB00
		270 "	85 x 76	30	1.9	< 40	480	DCP6N06270EC00
		315 "	85 x 85	30	1.8	< 40	540	DCP6N06315ED00
		360 "	85 x 95	30	1.7	< 40	600	DCP6N06360EE00
		450 "	85 x 110	30	1.7	< 40	690	DCP6N06450EF00
		480 "	85 x 120	35	1.8	< 40	700	DCP6N06480E000
		550 "	85 x 132	35	1.8	< 40	850	DCP6N06550E100
		620 "	85 x 140	35	1.8	< 40	880	DCP6N06620EG00
		730 "	116 x 95	40	1.7	< 40	1200	DCP6N06730EN00
		900 "	116 x 110	40	1.7	< 40	1390	DCP6N06900EO00
		980 "	116 x 120	40	1.8	< 40	1510	DCP6N06980EP00
		1130 "	116 x 132	40	1.8	< 40	1660	DCP6N07113EQ00
		1200 "	116 x 140	40	1.8	< 40	1760	DCP6N07120ER00
1100 VDC	920 VDC	120 μF	85 x 60	30	2.0	< 40	380	DCP6P06120EB00
		170 "	85 x 76	30	2.0	< 40	480	DCP6P06170EC00
		200 "	85 x 85	30	1.9	< 40	540	DCP6P06200ED00
		230 "	85 x 95	30	1.9	< 40	600	DCP6P06230EE00
		290 "	85 x 110	30	1.8	< 40	690	DCP6P06290EF00
		325 "	85 x 120	40	1.8	< 40	700	DCP6P06325E000
		360 "	85 x 132	40	1.8	< 40	850	DCP6P06360E100
		390 "	85 x 140	40	2.0	< 40	880	DCP6P06390EG00
		470 "	116 x 95	40	1.8	< 40	1200	DCP6P06470EN00
		580 "	116 x 110	40	1.8	< 40	1390	DCP6P06580EO00
		630 "	116 x 120	40	1.7	< 40	1510	DCP6P06630EP00
		720 "	116 x 132	40	1.7	< 40	1660	DCP6P06720EQ00
		780 "	116 x 140	40	1.6	< 40	1760	DCP6P06780ER00

Contacts can handle: peak currents (repetitive) \hat{I} up to 5 kA
surge currents (isolated cases) I_S up to 20 kA

Customer-specific capacitances or voltages on request

* General guide

Part number completion:	
Tolerance:	20 % = M
	10 % = K
	5 % = J
Packing:	bulk = S
Connection:	male = 0M
	female = 0F

Rights reserved to amend design data without prior notification.

Continuation

General Data

U_R		C_N	D x L mm	I_{rms} (max.)* at 70°C A	ESR (1 kHz)* mΩ	L_e nH	Approx. weight g	Part number
70° C	85° C							
1300 VDC	1100 VDC	85 μF	85 x 60	30	2.1	< 40	380	DCP6R25850EB00
		120 "	85 x 76	30	2.1	< 40	480	DCP6R26120EC00
		135 "	85 x 85	30	1.9	< 40	540	DCP6R26135ED00
		160 "	85 x 95	30	1.9	< 40	600	DCP6R26160EE00
		200 "	85 x 110	30	1.8	< 40	690	DCP6R26200EF00
		215 "	85 x 120	30	1.8	< 40	700	DCP6R26215E000
		250 "	85 x 132	40	2.2	< 40	850	DCP6R26250E100
		270 "	85 x 140	40	2.2	< 40	880	DCP6R26270EG00
		320 "	116 x 95	40	1.8	< 40	1200	DCP6R26320EN00
		390 "	116 x 110	40	1.8	< 40	1390	DCP6R26390EQ00
		430 "	116 x 120	40	1.7	< 40	1510	DCP6R26430EP00
		490 "	116 x 132	40	1.7	< 40	1660	DCP6R26490EQ00
		530 "	116 x 140	40	1.6	< 40	1760	DCP6R26530ER00
		1500 VDC	1250 VDC	75 μF	85 x 60	25	2.5	< 40
110 "	85 x 76			25	2.5	< 40	480	DCP6S06110EC00
120 "	85 x 85			25	2.3	< 40	540	DCP6S06120ED00
145 "	85 x 95			30	2.3	< 40	600	DCP6S06145EE00
180 "	85 x 110			30	2.3	< 40	690	DCP6S06180EF00
195 "	85 x 120			40	2.4	< 40	700	DCP6S06195E000
225 "	85 x 132			40	2.4	< 40	850	DCP6S06225E100
240 "	85 x 140			40	2.5	< 40	880	DCP6S06240EG00
290 "	116 x 95			40	1.8	< 40	1200	DCP6S06290EN00
355 "	116 x 110			40	1.8	< 40	1390	DCP6S06355EO00
390 "	116 x 120			40	1.7	< 40	1510	DCP6S06390EP00
445 "	116 x 132			40	1.7	< 40	1660	DCP6S06445EQ00
480 "	116 x 140			40	1.7	< 40	1760	DCP6S06480ER00

Contacts can handle: peak currents (repetitive) \hat{I} up to 5 kA
surge currents (isolated cases) I_S up to 20 kA

Customer-specific capacitances or voltages on request

* General guide

female

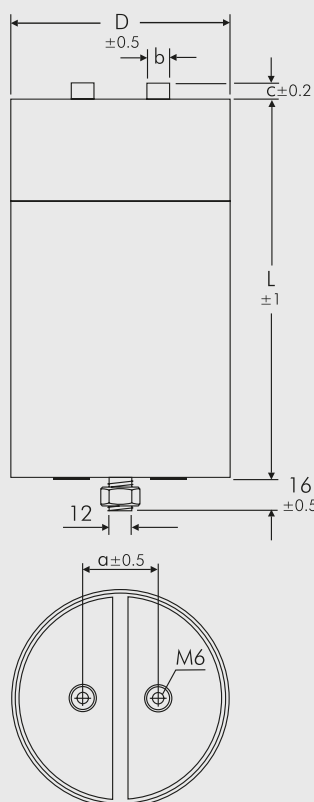

male

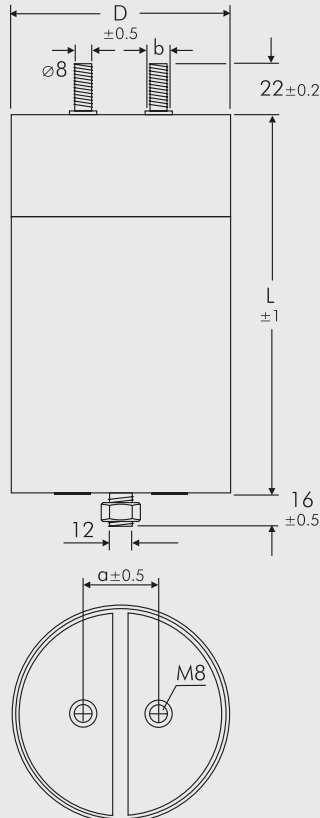

Part number completion:	
Tolerance:	20 % = M
	10 % = K
	5 % = J
Packing:	bulk = S
Connection:	male = 0M
	female = 0F

D	L	a	b	c
85	60	32	12	6
85	76	32	12	6
85	85	32	12	6
85	95	32	12	6
85	110	32	12	6
85	120	32	12	6
85	132	32	12	6
85	140	32	12	6
116	95	50	14	5
116	110	50	14	5
116	120	50	14	5
116	132	50	14	5
116	140	50	14	5

Dims. in mm.

Rights reserved to amend design data without prior notification.

Continuation: Versions with increased dimensioning for higher current carrying capability

General Data

U_R		C_N	D x L mm	I_{rms} (max.)* at 70° C A	ESR (1 kHz)* mΩ	L_e nH	Approx. weight g	Part number		
70° C	85° C									
600 VDC	450 VDC	640 μF	85 x 110	50	1.3	< 40	690	DCHPI06640EF00		
		920 "	85 x 140	50	1.3	< 40	880	DCHPI06920EG00		
		1040 "	85 x 155	60	1.3	< 40	980	DCHPI07104EH00		
		1240 "	85 x 185	60	1.3	< 60	1165	DCHPI07124EI00		
		1520 "	85 x 210	60	1.2	< 60	1400	DCHPI07152E200		
		1660 "	85 x 235	60	1.2	< 60	1480	DCHPI07166EJ00		
		1900 "	85 x 252	60	1.2	< 60	1590	DCHPI07190EK00		
		2060 "	85 x 260	60	1.2	< 60	1640	DCHPI07206EL00		
		2490 "	85 x 345	70	1.0	< 70	2190	DCHPI07249EM00		
		1260 "	116 x 110	80	1.2	< 40	1385	DCHPI07126EO00		
		1820 "	116 x 140	80	1.2	< 40	1765	DCHPI07182ER00		
		2060 "	116 x 158	80	1.1	< 40	1990	DCHPI07206ES00		
		2440 "	116 x 185	80	1.1	< 60	2330	DCHPI07244ET00		
		3000 "	116 x 215	80	1.0	< 60	2710	DCHPI07300EU00		
		3280 "	116 x 230	90	1.0	< 60	2900	DCHPI07328E700		
		3780 "	116 x 255	90	1.0	< 60	3210	DCHPI07378EV00		
		4060 "	116 x 295	90	1.0	< 70	3720	DCHPI07406EW00		
		4920 "	116 x 342	100	0.7	< 70	4350	DCHPI07492EX00		
		700 VDC	600 VDC	460 μF	85 x 110	50	1.3	< 40	690	DCHPK06460EF00
				660 "	85 x 140	50	1.3	< 40	880	DCHPK06660EG00
760 "	85 x 155			60	1.2	< 40	980	DCHPK06760EH00		
900 "	85 x 185			60	1.2	< 60	1165	DCHPK06900EI00		
1100 "	85 x 210			60	1.2	< 60	1400	DCHPK07110E200		
1200 "	85 x 235			60	1.2	< 60	1480	DCHPK07120EJ00		
1380 "	85 x 252			70	1.1	< 60	1590	DCHPK07138EK00		
1480 "	85 x 260			70	1.1	< 60	1640	DCHPK07148EL00		
1800 "	85 x 345			80	1.0	< 70	2190	DCHPK07180EM00		
920 "	116 x 110			80	1.3	< 40	1385	DCHPK06920EO00		
1320 "	116 x 140			80	1.3	< 40	1765	DCHPK07132ER00		
1500 "	116 x 158			80	1.3	< 40	1990	DCHPK07150ES00		
1780 "	116 x 185			80	1.2	< 60	2330	DCHPK07178ET00		
2180 "	116 x 215			90	1.2	< 60	2710	DCHPK07218EU00		
2380 "	116 x 230			90	1.0	< 60	2900	DCHPK07238E700		
2740 "	116 x 255			90	1.0	< 60	3210	DCHPK07274EV00		
2940 "	116 x 295			90	1.0	< 70	3720	DCHPK07294EW00		
3570 "	116 x 342			110	0.7	< 70	4350	DCHPK07357EX00		
900 VDC	760 VDC			380 μF	85 x 110	50	1.4	< 40	690	DCHPN06380EF00
				540 "	85 x 140	50	1.4	< 40	880	DCHPN06540EG00
		630 "	85 x 155	60	1.3	< 40	980	DCHPN06630EH00		
		720 "	85 x 185	60	1.3	< 60	1165	DCHPN06720EI00		
		900 "	85 x 210	60	1.1	< 60	1400	DCHPN06900E200		
		1000 "	85 x 235	70	1.0	< 60	1480	DCHPN07100EJ00		
		1140 "	85 x 252	70	0.9	< 60	1590	DCHPN07114EK00		
		1240 "	85 x 260	70	0.9	< 60	1640	DCHPN07124EL00		
		1500 "	85 x 345	80	0.7	< 70	2190	DCHPN07150EM00		

Contacts can handle: peak currents (repetitive) \hat{I} up to 10 kA
surge currents (isolated cases) I_S up to 40 kA

Customer-specific capacitances or voltages on request

* General guide

Part number completion:	
Tolerance:	20 % = M 10 % = K 5 % = J
Packing:	bulk = S
Connection:	male = 0M female = 0F

Rights reserved to amend design data without prior notification.

Continuation page 146



Continuation

General Data

U_R		C_N	D x L mm	I_{rms} (max.)* at 70° C A	ESR (1 kHz)* mΩ	L_e nH	Approx. weight g	Part number
70° C	85° C							
900 VDC	760 VDC	760 μF	116 x 110	80	1.3	< 40	1385	DCHPN06760EO00
		1100 "	116 x 140	80	1.3	< 40	1765	DCHPN07110ER00
		1240 "	116 x 158	80	1,3	< 40	1990	DCHPN07124ES00
		1460 "	116 x 185	80	1.2	< 60	2330	DCHPN07146ET00
		1800 "	116 x 215	90	< 60	< 60	2710	DCHPN07180EU00
		1960 "	116 x 230	90	1.0	< 60	2900	DCHPN07196E700
		2260 "	116 x 255	90	1.0	< 60	3210	DCHPN07226EV00
		2400 "	116 x 295	90	1.0	< 70	3720	DCHPN07240EW00
		2940 "	116 x 342	110	0.7	< 70	4350	DCHPN07294EX00
		1100 VDC	920 VDC	240 μF	85 x 110	50	1.3	< 40
340 "	85 x 140			50	1.2	< 40	880	DCHPP06340EG00
400 "	85 x 155			50	1.2	< 40	980	DCHPP06400EH00
460 "	85 x 185			50	1.2	< 60	1165	DCHPP06460EI00
580 "	85 x 210			60	1.2	< 60	1400	DCHPP06580E200
640 "	85 x 235			60	1.1	< 60	1480	DCHPP06640EJ00
720 "	85 x 252			60	1.1	< 60	1590	DCHPP06720EK00
780 "	85 x 260			60	1.2	< 60	1640	DCHPP06780EL00
960 "	85 x 345			80	1.0	< 70	2190	DCHPP06960EM00
480 "	116 x 110			80	1.4	< 40	1385	DCHPP06480EO00
700 "	116 x 140			80	1.3	< 40	1765	DCHPP06700ER00
780 "	116 x 158			80	1.3	< 40	1990	DCHPP06780ES00
940 "	116 x 185			80	1.3	< 60	2330	DCHPP06940ET00
1160 "	116 x 215			90	1.2	< 60	2710	DCHPP07116EU00
1260 "	116 x 230			90	1.2	< 60	2900	DCHPP07126E700
1440 "	116 x 255			90	1.1	< 60	3210	DCHPP07144EV00
1560 "	116 x 295			90	1.0	< 70	3720	DCHPP07156EW00
1890 "	116 x 342	110	0.8	< 70	4350	DCHPP07189EX00		
1300 VDC	1100 VDC	170 μF	85 x 110	50	1.3	< 40	690	DCHPR26170EF00
		240 "	85 x 140	50	1.3	< 40	880	DCHPR26240EG00
		270 "	85 x 155	50	1.2	< 40	980	DCHPR26270EH00
		320 "	85 x 185	60	1.2	< 60	1165	DCHPR26320EI00
		400 "	85 x 210	60	1.2	< 60	1400	DCHPR26400E200
		440 "	85 x 235	60	1.1	< 60	1480	DCHPR26440EJ00
		500 "	85 x 252	60	1.1	< 60	1590	DCHPR26500EK00
		540 "	85 x 260	60	1.2	< 60	1640	DCHPR26540EL00
		660 "	85 x 345	80	1.0	< 70	2190	DCHPR26660EM00
		330 "	116 x 110	80	1.4	< 40	1385	DCHPR26330EO00
		480 "	116 x 140	80	1.4	< 40	1765	DCHPR26480ER00
		540 "	116 x 158	80	1.3	< 40	1990	DCHPR26540ES00
		640 "	116 x 185	80	1.3	< 60	2330	DCHPR26640ET00
		780 "	116 x 215	90	1.2	< 60	2710	DCHPR26780EU00
		860 "	116 x 230	90	1.2	< 60	2900	DCHPR26860E700
		980 "	116 x 255	90	1.1	< 60	3210	DCHPR26980EV00
		1060 "	116 x 295	90	1.1	< 70	3720	DCHPR27106EW00
1290 "	116 x 342	110	0.8	< 70	4350	DCHPR27129EX00		

Contacts can handle: peak currents (repetitive) \hat{I} up to 10 kA
surge currents (isolated cases) I_S up to 40 kA

Customer-specific capacitances or voltages on request

* General guide

Part number completion:

Tolerance: 20 % = M
10 % = K
5 % = J
Packing: bulk = S
Connection: male = 0M
female = 0F

Rights reserved to amend design data without prior notification.

Continuation page 147

Continuation

General Data

U_R		C_N	D x L mm	I_{rms} (max.)* at 70° C A	ESR (1 kHz)* mΩ	L_e nH	Approx. weight g	Part number
70° C	85° C							
1500 VDC	1250 VDC	150 μF	85 x 110	50	1.3	< 40	690	DCHPS06150EF00
		220 "	85 x 140	50	1.3	< 40	880	DCHPS06220EG00
		240 "	85 x 155	50	1.2	< 40	980	DCHPS06240EH00
		290 "	85 x 185	60	1.2	< 60	1165	DCHPS06290EI00
		360 "	85 x 210	60	1.2	< 60	1400	DCHPS06360E200
		390 "	85 x 235	60	1.1	< 60	1480	DCHPS06390EJ00
		450 "	85 x 252	60	1.1	< 60	1590	DCHPS06450EK00
		480 "	85 x 260	60	1.1	< 60	1640	DCHPS06480EL00
		585 "	85 x 345	80	1.0	< 70	2190	DCHPS06585EM00
		300 "	116 x 110	80	1.5	< 40	1385	DCHPS06300EO00
		430 "	116 x 140	80	1.4	< 40	1765	DCHPS06430ER00
		490 "	116 x 158	80	1.4	< 40	1990	DCHPS06490ES00
		580 "	116 x 185	80	1.4	< 60	2330	DCHPS06580ET00
		710 "	116 x 215	90	1.3	< 60	2710	DCHPS06710EU00
		780 "	116 x 230	90	1.2	< 60	2900	DCHPS06780E700
		890 "	116 x 255	90	1.2	< 60	3210	DCHPS06890EV00
		960 "	116 x 295	90	1.1	< 70	3720	DCHPS06960EW00
		1170 "	116 x 342	110	0.8	< 70	4350	DCHPS07117EX00

Contacts can handle: peak currents (isolated) \hat{I} up to 5 kA
surge currents (isolated cases) I_S up to 20 kA

Customer-specific capacitances or voltages on request

* General guide

female

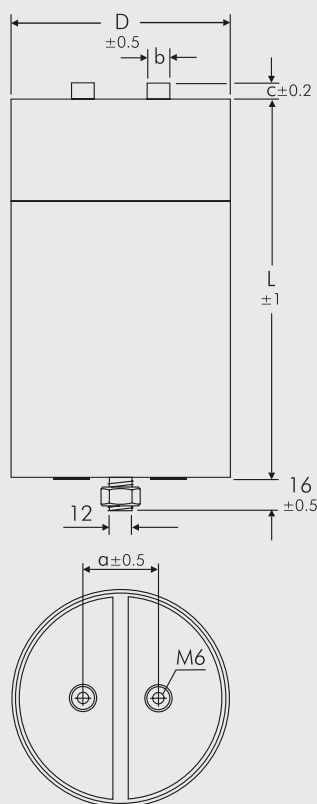

male

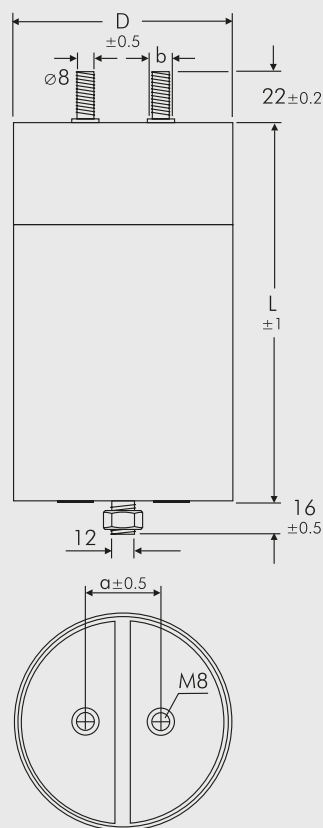

Part number completion:

Tolerance: 20 % = M
10 % = K
5 % = J
Packing: bulk = S
Connection: male = OM
female = OF

D	L	a	b	c
85	110	32	12	6
85	140	32	12	6
85	155	32	12	6
85	185	32	12	6
85	210	32	12	6
85	235	32	12	6
85	252	32	12	6
85	260	32	12	6
85	345	32	12	6
116	110	50	14	5
116	140	50	14	5
116	158	50	14	5
116	185	50	14	5
116	215	50	14	5
116	230	50	14	5
116	255	50	14	5
116	295	50	14	5
116	342	50	14	5

Dims. in mm.

Rights reserved to amend design data without prior notification.

Metallized Polypropylene (PP) - Capacitors for DC-Link Applications.
Capacitances from 140 μF to 8250 μF . Rated Voltages from 450 VDC to 1500 VDC.

Special Features

- Very high volume/capacitance ratio
- Self-healing, internal safety disconnecter
- Safe contact configurations by screwable plates
- Dry construction without electrolyte or oil
- Very low dissipation factor
- Negative capacitance change versus temperature
- Very low dielectric absorption
- According to RoHS 2015/863/EU
- Customer-specific tabs, capacitances or voltages on request
- 105° C version on request

Typical Applications

As intermediate circuit capacitor e. g. in high power converter technology

Construction

Dielectric:

Polypropylene (PP) film

Capacitor electrodes:

Vacuum-deposited

Internal construction:

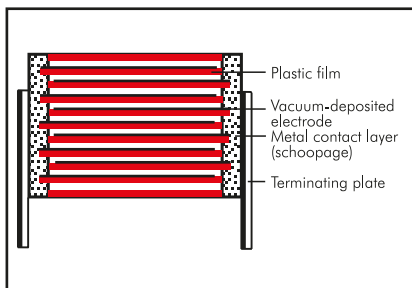

Encapsulation:

Solvent resistant, flame-retardant plastic case with PU seal

Terminations:

Tinned plates, customized plate configurations are possible.

Marking:

Colour: Black. Marking: Gold.

Electrical Data

Capacitance range: 140 μF to 8250 μF

Rated voltages:

450 VDC, 900 VDC, 1500 VDC

Capacitance tolerance: $\pm 10\%$

Operating temperature:

-55°C to $+85^\circ\text{C}$ ($+105^\circ\text{C}$ on request)

Insulation resistance at $+20^\circ\text{C}$:

$\geq 30\,000$ sec ($\text{M}\Omega \times \mu\text{F}$)

Measuring voltage: 100 V/1 min.

Self-inductance: ≤ 50 nH depending on tab configuration

ESR at $+20^\circ\text{C}$: See General Data.

Test voltage: $1.5 U_r$, 10 sec

Dielectric absorption: 0.05 %

Voltage derating:

A derating factor of 1.35% per K must be applied from $+70^\circ\text{C}$ for AC currents (I_{rms})

Reliability:

Operational life $> 100\,000$ hours at 70°C hot spot

Failure rate < 50 fit (hot spot $\leq 70^\circ\text{C}$)

Specific dissipation:

See General Data.

Standards: in accordance with IEC 61071

Mounting Recommendation

Excessive mechanical strain, e. g. pressure or shock onto the capacitor body, is to be avoided during mounting and usage of the capacitors. When fixing the capacitor the screw torque is to be limited to max. 5 Nm.

Packing

Transportation-safe packing in cardboard boxes.

For further details and graphs please refer to Technical Information.

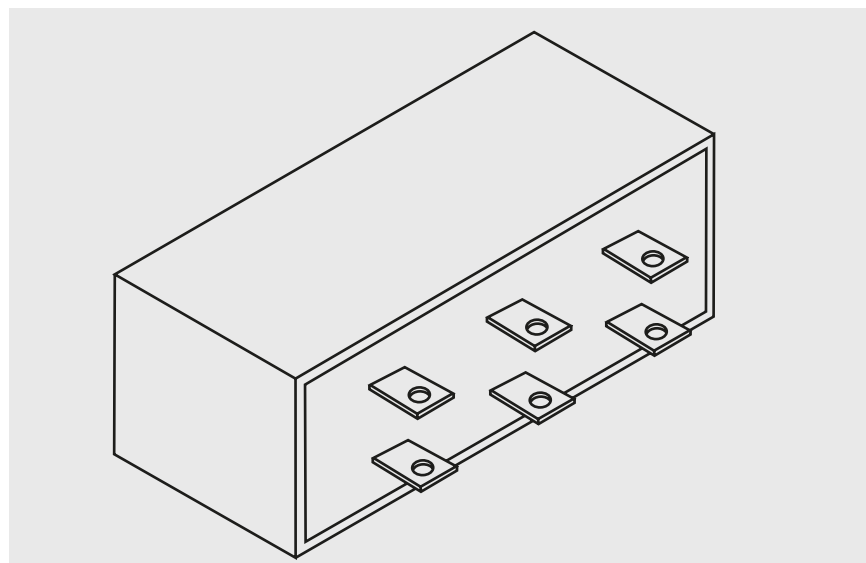

Continuation

General Data

U_R	C_N	E_N W_S	Size (mm)			I_{rms} (max.)* A	\hat{I}^* kA	I_S^* kA	ESR (1 kHz)* mΩ	R_{th}^* K/W	Approx. weight g	Part number
			W	H	L							
450 VDC	1440 μF	146	84	66	179	100	4.6	18.6	0.3	2.8	1220	DCHCH07144JB00KS00
	2400 "	243	84	66	291	170	7.7	30.9	0.2	1.8	1985	DCHCH07240JH00KS00
	3000 "	304	107	91	179	120	6.7	26.7	0.3	2.0	2145	DCHCH07300JC00KS00
	4950 "	501	130	114	179	140	8.7	34.9	0.3	1.5	3265	DCHCH07495JE00KS00
	5000 "	506	107	91	291	190	11.1	44.5	0.2	1.3	3485	DCHCH07500JI00KS00
	8250 "	835	130	114	291	210	14.5	58.1	0.2	1.1	5305	DCHCH07825JJ00KS00
900 VDC	450 μF	182	84	66	179	90	2.2	8.8	0.5	2.8	1220	DCHCN06450JB00KS00
	750 "	304	84	66	291	140	3.7	14.6	0.3	1.8	1985	DCHCN06750JH00KS00
	940 "	381	107	91	179	100	2.9	11.6	0.5	2.0	2145	DCHCN06940JC00KS00
	1500 "	608	130	114	179	110	3.5	14.1	0.5	1.5	3265	DCHCN07150JE00KS00
	1560 "	632	107	91	291	160	4.8	19.3	0.3	1.3	3485	DCHCN07156JI00KS00
	2600 "	1053	130	114	291	180	6.1	24.4	0.3	1.1	5305	DCHCN07260JJ00KS00
1500 VDC	140 μF	158	84	66	179	60	1.2	4.9	0.9	2.8	1220	DCHCS06140JB00KS00
	230 "	259	84	66	291	100	2.0	8.1	0.6	1.8	1985	DCHCS06230JH00KS00
	280 "	315	107	91	179	80	1.5	6.1	0.8	2.0	2145	DCHCS06280JC00KS00
	460 "	518	130	114	179	90	1.8	7.3	0.8	1.5	3265	DCHCS06460JE00KS00
	470 "	529	107	91	291	130	2.5	10.2	0.5	1.3	3485	DCHCS06470JI00KS00
	790 "	889	130	114	291	150	3.1	12.5	0.4	1.1	5305	DCHCS06790JJ00KS00

* General guide

Customer-specific tabs, capacitances or voltages on request

External wiring:

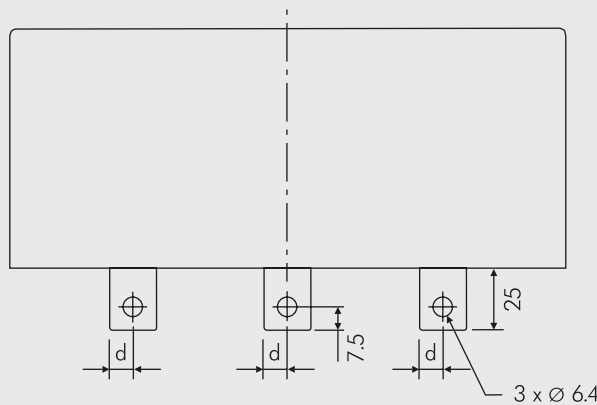
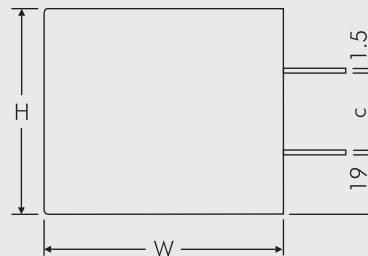
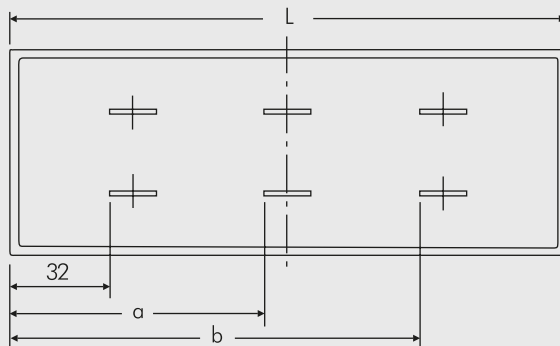
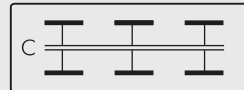

W	H	L	a	b	c	d
84	66	179	82	132	25	7.5
107	91	179	82	132	50	7.5
130	114	179	82	132	73	7.5
84	66	291	135.5	239	25	10
107	91	291	135.5	239	50	10
130	114	291	135.5	239	73	10

Dims. in mm. Case tolerances: general tolerances in accordance with ISO 2768-1 C (approximate)

Rights reserved to amend design data without prior notification.

DC-LINK Capacitors for SiC-Power Semiconductors

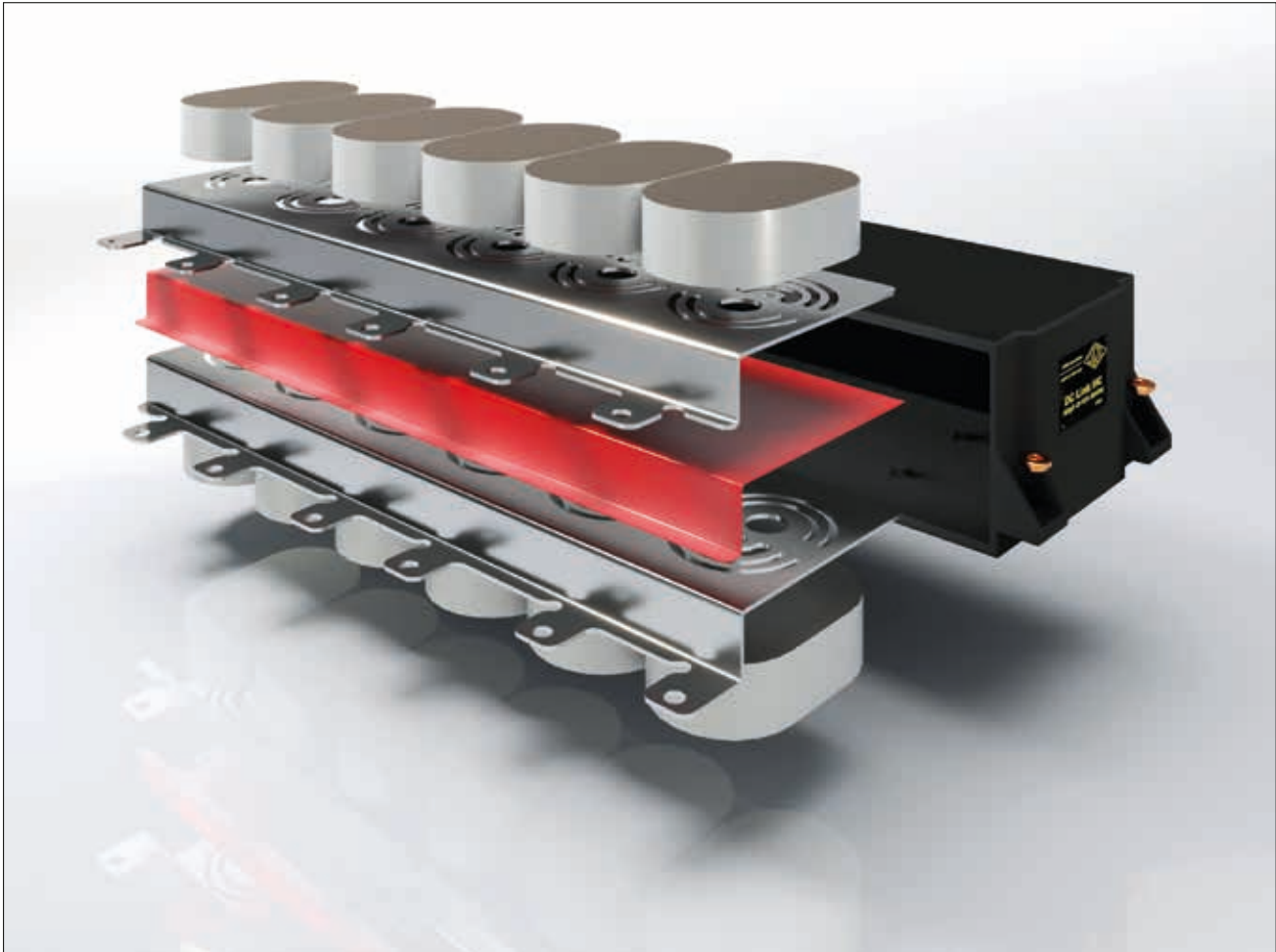

WIMA low-inductance (LI) DC-LINK capacitors are characterized by a flat, space-saving design with particularly low self-inductance. In addition to general applications, they are particularly suitable for applications in combination with silicon-based SiC power semiconductors.

Advantages

- The LI configuration with flat, space-saving design is available for all types and contact configurations
- Existing capacitor designs can easily be substituted with LI capacitors
- The LI design has no restrictions regarding the energy density per volume compared to previous DC-Link configurations
- The WIMA Single Side Cooling (SSC) achieves ideal heat dissipation with one-sided (water) cooling systems
- The LI design is available in 2- and 3-voltage level configurations.

Properties

- Low leakage inductance of ≤ 10 nH in almost any capacitor configuration
- Significant resonance point shift in high frequency ranges compared to conventional designs
- Optional: ESR optimized design and application temperatures up to $+125^{\circ}\text{C}$ on request.

Continuation

Impedance Change with Frequency

Reference Design

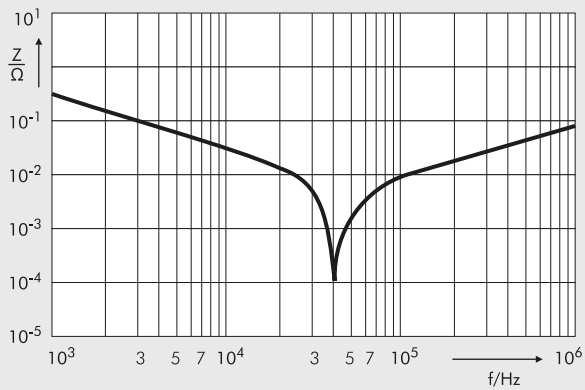

NEW: LI-Design

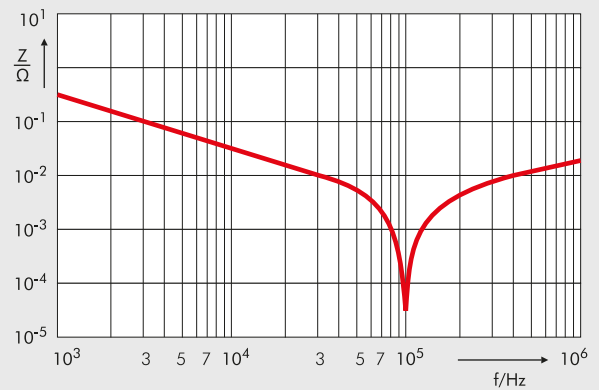

Examples

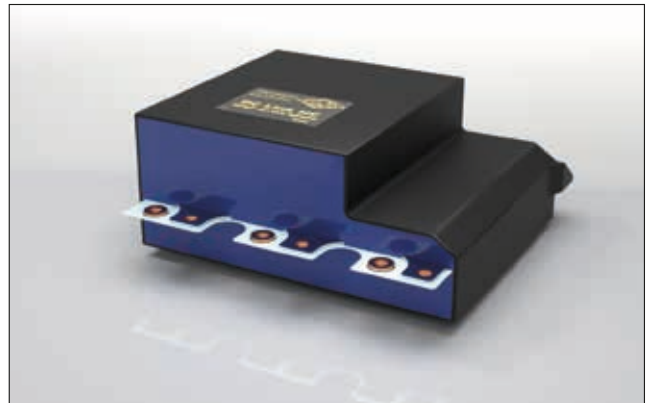

Double-Layer Capacitor (SuperCap) Modules with Very High Capacitances

Special Features

- Modules with very high capacitance values from 62 F to 500 F and rated voltages from 16 VDC to 125 VDC
- Discharge current up to 1900 A
- Maintenance-free
- Series connected
- Actively balanced
- According to RoHS 2015/863/EU

Construction

Encapsulation: Metal case IP65
Terminal tread size: M8 / M10
Marking: Colour: Black. Marking: Gold
Internal construction:

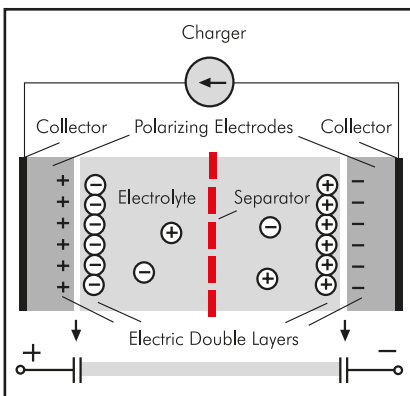

The WIMA PowerBlock range has a modular design. The configurations displayed are representative examples which at any time can be adapted in terms of capacitance, voltage or dimensions. Customized solutions can be realized on request.

Technical Options on Request

- Temperature monitoring
- Overvoltage signal
- Voltage monitoring
- Industrial connector/CAN-connector
- Application-adapted cooling
- Application-specific protection classes

General Data

U _R	C _N	Dimensions			Part number
		W	H	L	
16 V	105 F	157	69	250	MCPBA0B105MC00QV00
	500 F	157	156	250	MCPBA0B500MC00QV00
62.5 V	125 F	283	156	439	MCPBB4B125MC00QV00
125 V	62 F	409	156	575	MCPBDA620MC00QV00



Application:

WIMA PowerBlock modules store energy and release it within short time in e.g.:

- Motor start in construction, agriculture and earth moving machines, trucks, busses, vessels, generators
- Railway technology e.g. locomotives, electric tramway, metro etc.
- Hybrid and heavy transportation in e.g. construction, agricultural and forest machines, city busses, forklifts, cranes etc.
- Automated guided vehicles (AGV) in production facilities, in-plant logistic systems etc.
- Uninterruptible power supply (UPS) in hospitals, telecommunication systems, oil and gas extraction etc.
- Wind power systems e.g. in pitch control.

Advantages:

- Fast supply of several 100 - 1000 A in direct current operation
- Operating temperature range from -40° C to +65° C
- Maintenance-free operation with up to 1 million charge/discharge cycles
- Life expectancy > 10 years
- Low weight against batteries or secondary batteries
- Environmentally friendly materials
- No risk of damage due to complete discharge of the component
- Very fast recharge of the PowerBlock.

Conclusion:

The use of PowerBlocks as energy storage increases efficiency and life time of the applications, saves weight and cost for maintenance, and is environmentally friendly.

Continuation

Technical Data

Rated capacitance:	C _N [F]	105	500	125	62
Capacitance tolerance:	[%]	0%/+20%			
Rated voltage:	U _R [V]	16		62.5	125
Max. continuous current¹⁾:	I _C [A, rms]	54	130	130	130
Current, peak (1 sec):	I _P [A]	up to 680	up to 1900	up to 1900	up to 1900
Max. ESR, initial:	R _{DC} [mΩ]	5.2	2.1	8.3	16.4
Max. stored energy: ±20%	E _{max.} [Wh]	3.7	17.8	67.8	134.5
Operating temperature:	T _{op} [°C]	-45° C ... +65° C			
Storage temperature:	T _{st} [°C]	-45° C ... +75° C			
Weight:	m [kg]	2.3	4.4	16	31.9
Volume:	V [l]	2.7	6.1	19.4	36.7

Additional Data

Case:	-	AlMg3
Lug terminals:	-	M8 / M10

Comparative Data

Lifetime:					
in hours ²⁾	[h]	90 000, rated voltage, 25° C			
in cycles ³⁾	cycles	>1 million, rated voltage, 25° C			
Energy density:					
gravimetric	E _d [Wh/kg]	1.62	4.03	4.24	4.21
volumetric	E _v [Wh/l]	1.38	2.9	3.5	3.67

M10 x 1.5 negative terminal
tread depth: 20 - 22 mm
max. torque 15 Nm

M8 x 1.25 positive terminal
tread depth: 20 - 22 mm
max. torque 15 Nm

Dims. in mm.

C _N	W ±1	H ±1	L ±1	W1 ±1	L1 ±1	a ±1	b ±1
62 F	409	156	575	376	555	97.1	189
105 F	157	69	250	695	230	47	63
125 F	283	156	439	250	419	46.6	189
500 F	157	156	250	124	230	47	63

1) ΔT = 40° C
 2) Requirements: ΔC < 20% decrease, ESR < 100% increase.
 3) Requirements: ΔC < 20% decrease, ESR < 100% increase.

Rights reserved to amend design data without prior notification.

Fields of Application for WIMA PowerBlock Modules

Motor Start

WIMA PowerBlock Modules replace, protect or support conventional batteries to reliably crank big diesel engines in e.g.:

- Trucks
- Construction, agricultural and earth moving machines
- Busses and trains
- Vessels
- Generators
- etc.

During start-up of a big diesel engine the energy requirement is quite high. By using WIMA PowerBlock modules the battery layout can be designed smaller and thus lower in weight which leads to a significant reduction of fuel cost and emission of harmful substances.

Railway Technology

WIMA PowerBlock modules store braking energy and immediately release it for engine starting, acceleration or peak-load levelling in e.g.:

- Locomotives
- Electric tramway
- etc.

The use of PowerBlock modules as energy storage increases efficiency and life time of transportation systems, saves weight and cost for maintenance, and is environmentally friendly.

Hybrid/Heavy Transportation

WIMA PowerBlock modules in hybrid drives support diesel engines with fast and frequent dynamic loads in e.g.:

- City busses
- Construction machines, agricultural machines and forestry equipment
- Forklifts, cranes
- etc.

The use of WIMA PowerBlock modules as energy storage leads to significant saving in terms of fuel consumption and considerably reduces exhaust and noise emission.

Automated Guided Vehicles (AGV)

WIMA PowerBlock modules serve as rechargeable or exchangeable energy storage in independent, automated guided vehicles (AGV) in e.g.:

- Warehouse and distribution environments
- Production facilities
- In-plant logistic systems
- etc.

The use of PowerBlock modules as energy storage saves weight, reduces cost for maintenance and increases efficiency and life time of the transportation system.

Uninterruptible Power Supply (UPS)

Cascaded WIMA PowerBlock modules are used as emergency power supply in e.g.:

- Hospitals
- Telecommunication systems
- Oil production plants
- Gas extraction
- etc.

By reliably bridging short-term power outages cost-intensive system crashes can be avoided.

WIMA Competence

WIMA has many years of experience in construction of customized energy storage modules based on double layer capacitors. Design and construction of individual solutions is coordinated with the user. Customer's advantages are:

- High expertise due to many years of manufacturing and field experience
- Individual design related to
 - environment
 - space requirements
 - fixing
 - connecting options
- Flexible capacitance or voltage due to serial or parallel cascading of single cells with 350 F to 3,000 F
- Laser-based, reliable welding of the single cells
- Robust, vibration resistant construction according to IP-25 - IP-69 K on demand
- Various technical options, e.g.:
 - temperature monitoring
 - overvoltage signal
 - voltage monitoring
 - industrial connector/CAN-connector
 - application-adapted cooling
 - custom-specific protection class
- Pulse current, endurance and voltage tests according to IEC 62576 or DIN EN 62391-1
- Prototype and small series production
- Ready for connection supply.

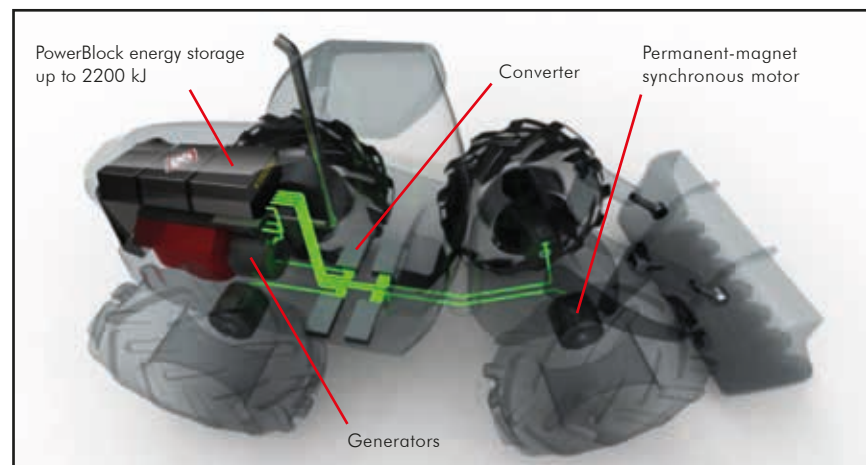

VISED0 electrified wheel-loader using WIMA PowerBlock energy storage modules.



A WIMA part number consists of 18 digits and is composed as follows:

- Field 1 - 4: Type description
- Field 5 - 6: Rated voltage
- Field 7 - 10: Capacitance
- Field 11 - 12: Size and PCM
- Field 13 - 14: Version code (e.g. Snubber versions)
- Field 15: Capacitance tolerance
- Field 16: Packing
- Field 17 - 18: Pin length (untaped)

1	2	3	4	5	6	7	8	9	10	11	12	13	14	15	16	17	18
M	K	S	2	C	0	2	1	0	0	1	A	0	0	M	S	S	D
MKS 2				63 VDC		0.01 µF			2.5x6.5x7.2			-		20%	bulk	6 -2	

<p>Type description:</p> <p>SMD-PET = SMDT SMD-PEN = SMDN SMD-PPS = SMDI FKP 02 = FKPO MKS 02 = MKSO FKS 2 = FKS2 FKP 2 = FKP2 FKS 3 = FKS3 FKP 3 = FKP 3 MKS 2 = MKS2 MKP 2 = MKP2 MKS 4 = MKS4 MKP 4 = MKP4 MKP 10 = MKP1 FKP 4 = FKP4 FKP 1 = FKP1 MKP-X2 = MKX2 MKP-X1 R = MKX1 MKP-Y2 = MKY2 MKP 4F = MKPF Snubber MKP = SNMP Snubber FKP = SNFP GTO MKP = GTOM DC-LINK MKP 4 = DCP4 DC-LINK MKP 6 = DCP6 DC-LINK HC = DCHC</p>	<p>Rated voltage:</p> <p>50 VDC = B0 63 VDC = C0 100 VDC = D0 250 VDC = F0 400 VDC = G0 450 VDC = H0 520 VDC = H2 600 VDC = I0 630 VDC = J0 700 VDC = K0 800 VDC = L0 850 VDC = M0 900 VDC = N0 1000 VDC = O1 1100 VDC = P0 1200 VDC = Q0 1250 VDC = R0 1500 VDC = S0 1600 VDC = T0 1700 VDC = TA 2000 VDC = U0 2500 VDC = V0 3000 VDC = W0 4000 VDC = X0 6000 VDC = Y0 230 VAC = 3Y 275 VAC = 1W 300 VAC = 2W 305 VAC = AW 350 VAC = BW 440 VAC = 4W ...</p>	<p>Capacitance:</p> <p>22 pF = 0022 47 pF = 0047 100 pF = 0100 150 pF = 0150 220 pF = 0220 330 pF = 0330 470 pF = 0470 680 pF = 0680 1000 pF = 1100 1500 pF = 1150 2200 pF = 1220 3300 pF = 1330 4700 pF = 1470 6800 pF = 1680 0.01 µF = 2100 0.022 µF = 2220 0.047 µF = 2470 0.1 µF = 3100 0.22 µF = 3220 0.47 µF = 3470 1 µF = 4100 2.2 µF = 4220 4.7 µF = 4470 10 µF = 5100 22 µF = 5220 47 µF = 5470 100 µF = 6100 220 µF = 6220 1000 µF = 7100 1500 µF = 7150 ...</p>	<p>Size:</p> <p>4.8x3.3x3 Size 1812 = KA 4.8x3.3x4 Size 1812 = KB 5.7x5.1x3.5 Size 2220 = QA 5.7x5.1x4.5 Size 2220 = QB 7.2x6.1x3 Size 2824 = TA 7.2x6.1x5 Size 2824 = TB 10.2x7.6x5 Size 4030 = VA 12.7x10.2x6 Size 5040 = YA 15.3x13.7x7 Size 6054 = YA 2.5x7x4.6 PCM2.5 = 0B 3x7.5x4.6 PCM2.5 = 0C 2.5x6.5x7.2 PCM5 = 1A 3x7.5x7.2 PCM5 = 1B 2.5x7x10 PCM7.5 = 2A 3x8.5x10 PCM7.5 = 2B 3x9x13 PCM10 = 3A 4x9x13 PCM10 = 3C 5x11x18 PCM15 = 4B 6x12.5x18 PCM15 = 4C 5x14x26.5 PCM22.5 = 5A 6x15x26.5 PCM22.5 = 5B 9x19x31.5 PCM27.5 = 6A 11x21x31.5 PCM27.5 = 6B 9x19x41.5 PCM37.5 = 7A 11x22x41.5 PCM37.5 = 7B 19x31x56 PCM 48.5 = 8D 25x45x57 PCM 52.5 = 9D ...</p> <p>Version code:</p> <p>Standard = 00 Version A1 = 1A Version A1.1.1 = 1B Version A2 = 2A ...</p>	<p>Tolerance:</p> <p>±20% = M ±10% = K ±5% = J ±2.5% = H ±1% = E ...</p> <p>Packing:</p> <p>AMMO H16.5 340x340 = A AMMO H16.5 490x370 = B AMMO H18.5 340x340 = C AMMO H18.5 490x370 = D REEL H16.5 360 = F REEL H16.5 500 = H REEL H18.5 360 = I REEL H18.5 500 = J ROLL H16.5 = N ROLL H18.5 = O BLISTER W12 180 = P BLISTER W12 330 = Q BLISTER W16 330 = R BLISTER W24 330 = T Bulk/TPS Standard = S ...</p> <p>Pin length (untaped)</p> <p>3.5 ±0.5 = C9 6 -2 = SD 16 ±1 = P1 ...</p> <p>Pin length (taped)</p> <p>none = 00</p>
--	---	---	--	---

The data on this page is not complete and serves only to explain the part number system. Part number information is listed on the pages of the respective WIMA range.



Blister Tape Packaging and Packing Units of the WIMA SMD Capacitors

Tape reel:

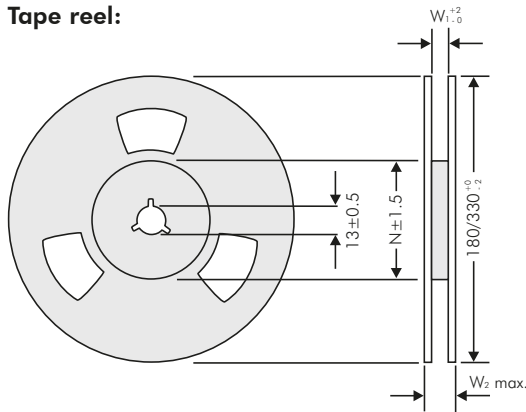

Tape advance and return:

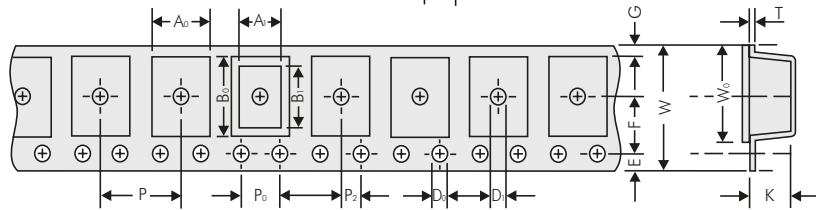
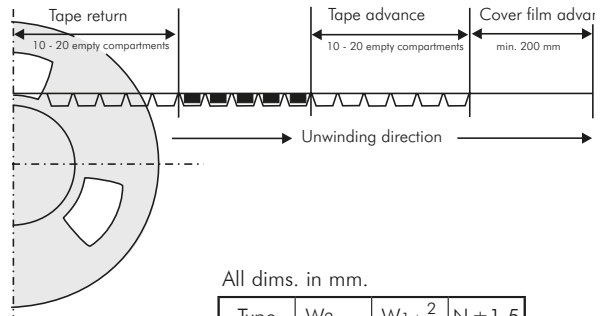

All dims. in mm.

Type	W _{2max}	W ₁ ± 0.2	N ± 1.5
1812	19	12.4	62
2220	19	12.4	62
2824	19	12.4	62
4030	22.4	16.4	60
5040	30.4	24.4	90
6054	30.4	24.4	90

Packing units

Size Code 1812		A ₀ ± 0.1	A ₁	B ₀ ± 0.1	B ₁	D ₀ +0.1 -0	D ₁ +0.1 -0	P ± 0.1	P ₀ * ± 0.1	P ₂ ± 0.05	E ± 0.1	F ± 0.05	G	W ± 0.3	W ₀ ± 0.2	K ± 0.1	T ± 0.1
Box size	Code																
4.8x3.3x3	KA	3.55	3.3	5.1	4.8	P1.5	P1.5	8	4	2	1.75	5.5	2.2	12	9.5	3.4	0.3
4.8x3.3x4	KB	3.55	3.3	5.1	4.8	P1.5	P1.5	8	4	2	1.75	5.5	2.2	12	9.5	4.4	0.3

taped Reel	taped Reel	bulk
180 mm Ø	330 mm Ø	Standard
700	2500	3000
500	2000	3000

Size Code 2220		A ₀ ± 0.1	A ₁	B ₀ ± 0.1	B ₁	D ₀ +0.1 -0	D ₁ +0.1 -0	P ± 0.1	P ₀ * ± 0.1	P ₂ ± 0.05	E ± 0.1	F ± 0.05	G	W ± 0.3	W ₀ ± 0.2	K ± 0.1	T ± 0.1
Box size	Code																
5.7x5.1x3.5	QA	6.3	5.7	5.6	5.1	P1.5	P1.5	8	4	2	1.75	5.5	1.95	12	9.5	3.7	0.3
5.7x5.1x4.5	QB	6.3	5.7	5.6	5.1	P1.5	P1.5	8	4	2	1.75	5.5	1.95	12	9.5	4.7	0.3

taped Reel	taped Reel	bulk
180 mm Ø	330 mm Ø	Standard
500	1800	3000
400	1500	3000

Size Code 2824		A ₀ ± 0.1	A ₁	B ₀ ± 0.1	B ₁	D ₀ +0.1 -0	D ₁ +0.1 -0	P ± 0.1	P ₀ * ± 0.1	P ₂ ± 0.05	E ± 0.1	F ± 0.05	G	W ± 0.3	W ₀ ± 0.2	K ± 0.1	T ± 0.1
Box size	Code																
7.2x6.1x3	TA	6.6	6.1	7.7	7.2	P1.5	P1.5	12	4	2	1.75	5.5	0.9	12	9.5	3.4	0.3
7.2x6.1x5	TB	6.6	6.1	7.7	7.2	P1.5	P1.5	12	4	2	1.75	5.5	0.9	12	9.5	5.4	0.4

taped Reel	bulk
330 mm Ø	Standard
1500	2000
750	2000

Code	A ₀ ± 0.1	A ₁	B ₀ ± 0.1	B ₁	D ₀ +0.1 -0	D ₁ +0.1 -0	P ± 0.1	P ₀ * ± 0.1	P ₂ ± 0.05	E ± 0.1	F ± 0.05	G	W ± 0.3	W ₀ ± 0.2	K ± 0.1	T ± 0.1	
Size Code 4030	VA	10.7	10.2	8.1	9.1	P1.5	P1.5	16	4	2	1.75	7.5	1.9	16	13.3	5.5	0.3
Size Code 5040	XA	13.5	12.7	11	11.5	P1.5	P1.5	16	4	2	1.75	11.5	4.7	24	21.3	6.5	0.3
Size Code 6054	YA	17.0	16.5	15.6	15.0	P1.5	P1.5	20	4	2	1.75	11.5	2.95	24	21.3	7.5	0.3

taped Reel	bulk
330 mm Ø	Standard
775	2000
600	1000
450	500

* cumulative after 10 steps p 0.2 mm max.
Samples and pre-production needs on request or 1 Reel minimum.

Part number codes for SMD packing

W (Blister)	Ø in mm	Code
12	180	P
12	330	Q
16	330	R
24	330	T

Bulk Standard	S
---------------	----------

Typical Dimensions for Taping Configuration

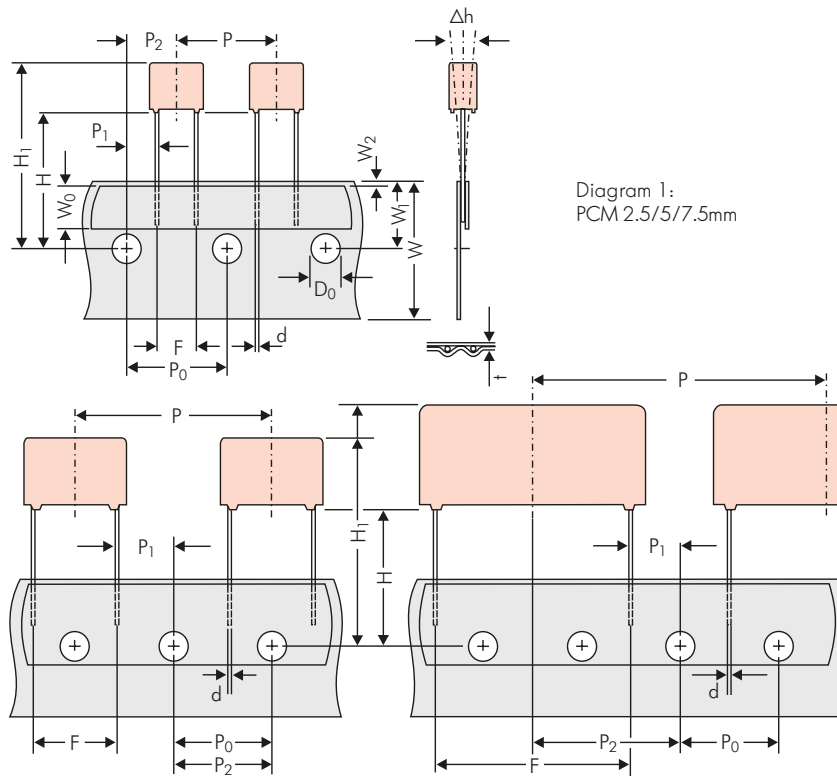

Diagram 1:
PCM 2.5/5/7.5mm

Diagram 2: PCM 10/15 mm

Diagram 3: PCM 22.5 and 27.5*mm

*PCM 27.5 tapping possible with two feed holes between components

Designation	Symbol	Dimensions for Radial Taping						
		PCM 2.5 tapping	PCM 5 tapping	PCM 7.5 tapping	PCM 10 tapping*	PCM 15 tapping*	PCM 22.5 tapping	PCM 27.5 tapping
Carrier tape width	W	18.0 ±0.5	18.0 ±0.5	18.0 ±0.5	18.0 ±0.5	18.0 ±0.5	18.0 ±0.5	18.0 ±0.5
Hold-down tape width	W ₀	6.0 for hot-sealing adhesive tape	6.0 for hot-sealing adhesive tape	12.0 for hot-sealing adhesive tape	12.0 for hot-sealing adhesive tape	12.0 for hot-sealing adhesive tape	12.0 for hot-sealing adhesive tape	12.0 for hot-sealing adhesive tape
Hole position	W ₁	9.0 ±0.5	9.0 ±0.5	9.0 ±0.5	9.0 ±0.5	9.0 ±0.5	9.0 ±0.5	9.0 ±0.5
Hold-down tape position	W ₂	0.5 to 3.0 max.	0.5 to 3.0 max.	0.5 to 3.0 max.	0.5 to 3.0 max.	0.5 to 3.0 max.	0.5 to 3.0 max.	0.5 to 3.0 max.
Feed hole diameter	D ₀	4.0 ±0.2	4.0 ±0.2	4.0 ±0.2	4.0 ±0.2	4.0 ±0.2	4.0 ±0.2	4.0 ±0.2
Pitch of component	P	12.7 ±1.0	12.7 ±1.0	12.7 ±1.0	25.4 ±1.0	25.4 ±1.0	38.1 ±1.5	*38.1 ±1.5 or 50.8 ±1.5
Feed hole pitch	P ₀	12.7 ±0.3 error max. 1.0 mm/20 pitch	12.7 ±0.3 error max. 1.0 mm/20 pitch	12.7 ±0.3 error max. 1.0 mm/20 pitch	12.7 ±0.3 error max. 1.0 mm/20 pitch	12.7 ±0.3 error max. 1.0 mm/20 pitch	12.7 ±0.3 error max. 1.0 mm/20 pitch	12.7 ±0.3 error max. 1.0 mm/20 pitch
Feed hole centre to pin	P ₁	5.1 ±0.5	3.85 ±0.7	2.6 ±0.7	7.7 ±0.7	5.2 ±0.7	7.8 ±0.7	5.3 ±0.7
Hole centre to component centre	P ₂	6.35 ±1.3	6.35 ±1.3	6.35 ±1.3	12.7 ±1.3	12.7 ±1.3	19.05 ±1.3	19.05 ±1.3
Feed hole centre to bottom edge of the component	H _▲	16.5 ±0.3 18.5 ±0.5	16.5 ±0.3 18.5 ±0.5	16.5 ±0.5 18.5 ±0.5	16.5 ±0.5 18.5 ±0.5	16.5 ±0.5 18.5 ±0.5	16.5 ±0.5 18.5 ±0.5	16.5 ±0.5 18.5 ±0.5
Feed hole centre to top edge of the component	H ₁	H+H _{component} < H ₁ 32.25 max.	H+H _{component} < H ₁ 32.25 max.	H+H _{component} < H ₁ 24.5 to 31.5	H+H _{component} < H ₁ 25.0 to 31.5	H+H _{component} < H ₁ 26.0 to 37.0	H+H _{component} < H ₁ 30.0 to 43.0	H+H _{component} < H ₁ 35.0 to 45.0
Pin spacing at upper edge of carrier tape	F	2.5 ±0.5	5.0 ^{+0.8} _{-0.2}	7.5 ±0.8	10.0 ±0.8	15 ±0.8	22.5 ±0.8	27.5 ±0.8
Pin diameter	d	0.4 ±0.05	0.5 ±0.05	•0.5 ±0.05 or 0.6 ^{+0.06} _{-0.05}	•0.5 ±0.05 or 0.6 ^{+0.06} _{-0.05}	0.8 ^{+0.08} _{-0.05}	0.8 ^{+0.08} _{-0.05}	0.8 ^{+0.08} _{-0.05}
Component alignment	Δh	± 2.0 max.	± 2.0 max.	± 3.0 max.	± 3.0 max.	± 3.0 max.	± 3.0 max.	± 3.0 max.
Total tape thickness	t	0.6 ±0.2	0.6 ±0.2	0.6 ±0.2	0.6 ±0.2	0.6 ±0.2	0.6 ±0.2	0.6 ±0.2
Package (see also page 158)	▲	ROLL/AMMO			AMMO			
		REEL Ø 360 max. Ø 30 ±1	B 52 ±2 58 ±2	depending on comp. dimensions	REEL Ø 360 max. Ø 30 ±1	B 52 ±2 58 ±2 66 ±2	or REEL Ø 500 max. Ø 25 ±1	B 54 ±2 60 ±2 68 ±2
Unit		see details page 159.						

▲ When ordering please specify dimension H and required packaging type.

Dims in mm.

• Diameter of pins see General Data.

Please clarify customer-specific deviations with the manufacturer.

* PCM 10 and PCM 15 can be crimped to PCM 7.5.

Position of components according to PCM 7.5 (sketch 1). P₀ = 12.7 or 15.0 is possible

Types of Tape Packaging of Capacitors for Automatic Radial Insertion

■ ROLL Packaging

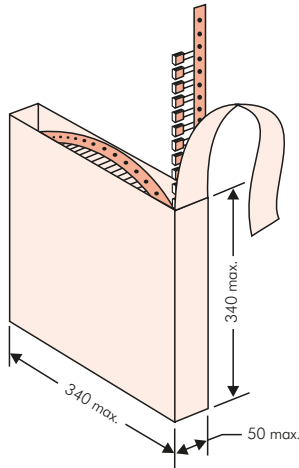

■ AMMO Packaging

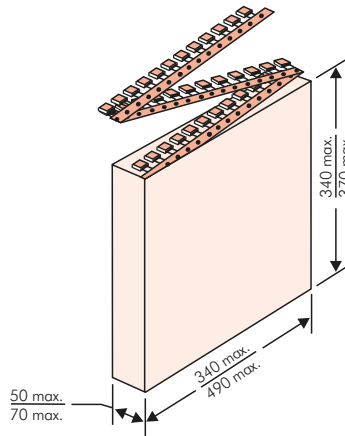

■ REEL Packaging

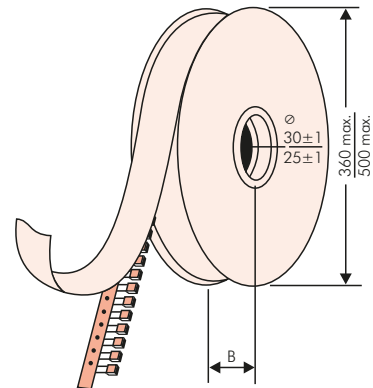

BAR CODE (Labelling)

Labelling of package units in plain text and with alphanumeric Bar Code

- WIMA supplier number
- Date code
- Customer's P/O number
- P/O line
- Customer's part number
- WIMA part number
- Quantity
- WIMA confirmation number
- Country of origin
- Customer name
- Handling unit number
- Week of delivery.

In addition part description of

- article
- capacitance value
- rated voltage
- dimensions
- technical note
- capacitance tolerance
- packing
- connecting information

WIMA Best Capacitors Made in Germany
Werk Aurich

Supplier-ID: LIEF.NR. Date Code: 20210419

Purchase Order No. (P/O): Bestellung xyz P/O line: 100

Customer Part No.: KUNDENTEILENUMMER

WIMA Part No.: MKP1F041006B00KSSD Quantity: 459

WIMA Confirmation No.: 0001105072000100 RoHS
2011/65/EU

Customer No.: 0000100002 COO: DE

Gross Weight [g]: 4557

WIMA – MKP 10 WIMA Part No.: MKP1F041006B00KSSD

MKP 10 1.0 µF 250 VDC 11x21x31.5 RM27.5

Standard 10% Lose – Standard Drähte 6–2

Vorlage Debitor Inland

0001105072000100

1002021443 QTY: 459 Week 19/2021

BARCODE PDF417
BARCODE 2D Datamatrix

Packing Quantities for Capacitors with Radial Pins in PCM 2.5 mm to 27.5 mm



PCM	Size				bulk	pcs. per packing unit											
						ROLL		REEL				AMMO					
	W	H	L	Codes		S	N	O	Ø 360		Ø 500		340 x 340		490 x 370		
								H16.5	H18.5	H16.5	H18.5	H16.5	H18.5	H16.5	H18.5	H16.5	H18.5
2.5 mm	2.5	7	4.6	0B	5000			2200			2500			2800			
	3	7.5	4.6	0C	5000			2000			2300			2300			
	3.8	8.5	4.6	0D	5000			1500			1800			1800			
	4.6	9	4.6	0E	5000			1200			1500			1500			
	5.5	10	4.6	0F	5000			900			1200			1200			
5 mm	2.5	6.5	7.2	1A	5000			2200			2500			2800			
	3	7.5	7.2	1B	5000			2000			2300			2300			
	3.5	8.5	7.2	1C	5000			1600			2000			2000			
	4.5	6	7.2	1D	6000			1300			1500			1500			
	4.5	9.5	7.2	1E	4000			1300			1500			1500			
	5	10	7.2	1F	3500			1100			1400			1400			
	5.5	7	7.2	1G	4000			1000			1200			1200			
	5.5	11.5	7.2	1H	2500			1000			1200			1200			
	6.5	8	7.2	1I	2500			800			1000			1000			
	7.2	8.5	7.2	1J	2500			700			1000			1000			
	7.2	13	7.2	1K	2000			700			950			1000			
	8.5	10	7.2	1L	2000			600			800			800			
	8.5	14	7.2	1M	1500			600			800			800			
11	16	7.2	1N	1000			500			600			640				
7.5 mm	2.5	7	10	2A	5000					2500		4400	2500				
	3	8.5	10	2B	5000					2200		4300	2300			4150	
	4	9	10	2C	4000					1700		3200	1700			3000	
	4.5	9.5	10.3	2D	3500					1500		2900	1400			2700	
	5	10.5	10.3	2E	3000					1300		2500	1300				
	5.7	12.5	10.3	2F	2000					1000		2200	1100				
	7.2	12.5	10.3	2G	1500					900		1800	1000				
10 mm	3	9	13	3A	3000					1100		2200				1900	
	4	9	13	3C	3000					900		1600				1450	
	4	9.5	13	3D	3000					900		1600				1400	
	5	11	13	3F	3000					700		1300				1100	
	6	12	13	3G	2400						550		1100				1000
	6	12.5	13	3H	2400						550		1100				1000
	8	12	13	3I	2000						400		800				740
15 mm	5	11	18	4B	2400					600		1200				1150	
	6	12.5	18	4C	2000					500		1000				1000	
	7	14	18	4D	1600					450		900				850	
	8	15	18	4F	1200					400		800				740	
	9	14	18	4H	1200					350		700				650	
	9	16	18	4J	900					350		700				650	
	11	14	18	4M	1000					300		600				540	
22.5 mm	5	14	26.5	5A	1200							800				770	
	6	15	26.5	5B	1000							700				640	
	7	16.5	26.5	5D	760							600				550	
	8.5	18.5	26.5	5F	500							480				450	
	10.5	19	26.5	5G	594*							400				360	
	10.5	20.5	26.5	5H	594*							400				360	
11	21	26.5	5I	561*							380				350		
27.5 mm	9	19	31.5	6A	567*							460/340*					
	11	21	31.5	6B	459*							380/280*					
	13	24	31.5	6D	378*							300					
	15	26	31.5	6F	324*							270					
	17	29	31.5	6G	198*												
	17	34.5	31.5	6I	198*												
	20	39.5	31.5	6J	162*												

* for 2-inch transport pitches.

* TPS (Tray-Packing-System). Plate versions may have different packing units. Samples and pre-production needs on request.

Rights reserved to amend design data without prior notification.



Packing Quantities for Capacitors with Radial Pins in PCM 37.5 mm to 52.5 mm

PCM	Size				bulk	pcs. per packing unit											
						ROLL		REEL				AMMO					
	W	H	L	Codes		S	N	O	Ø 360		Ø 500		340 x 340		490 x 370		
								H16.5	H18.5	H16.5	H18.5	H16.5	H18.5	H16.5	H18.5	H16.5	H18.5
								F	I	H	J	A	C	B	D		
37.5 mm**	9	19	41.5	7A	441*	-	-	-	-	-	-	-	-	-	-	-	-
	11	22	41.5	7B	357*	-	-	-	-	-	-	-	-	-	-	-	-
	13	24	41.5	7C	294*	-	-	-	-	-	-	-	-	-	-	-	-
	15	26	41.5	7D	252*	-	-	-	-	-	-	-	-	-	-	-	-
	17	29	41.5	7E	154*	-	-	-	-	-	-	-	-	-	-	-	-
	19	32	41.5	7F	140*	-	-	-	-	-	-	-	-	-	-	-	-
	20	39.5	41.5	7G	126*	-	-	-	-	-	-	-	-	-	-	-	-
	24	45.5	41.5	7H	112*	-	-	-	-	-	-	-	-	-	-	-	-
	28	38	41.5	7L	84*	-	-	-	-	-	-	-	-	-	-	-	-
	31	46	41.5	7I	84*	-	-	-	-	-	-	-	-	-	-	-	-
	35	50	41.5	7J	35*	-	-	-	-	-	-	-	-	-	-	-	-
	40	55	41.5	7K	28*	-	-	-	-	-	-	-	-	-	-	-	-
48.5 mm**	19	31	56	8D	120*	-	-	-	-	-	-	-	-	-	-	-	
	23	34	56	8E	80*	-	-	-	-	-	-	-	-	-	-	-	
	27	37.5	56	8H	84*	-	-	-	-	-	-	-	-	-	-	-	
	33	48	56	8J	25*	-	-	-	-	-	-	-	-	-	-	-	
	37	54	56	8L	25*	-	-	-	-	-	-	-	-	-	-	-	
52.5 mm	25	45	57	9D	70*	-	-	-	-	-	-	-	-	-	-	-	
	30	45	57	9E	60*	-	-	-	-	-	-	-	-	-	-	-	
	35	50	57	9F	25*	-	-	-	-	-	-	-	-	-	-	-	
	45	55	57	9H	20*	-	-	-	-	-	-	-	-	-	-	-	
	45	65	57	9J	20*	-	-	-	-	-	-	-	-	-	-	-	

* TPS (Tray-Packing-System). Plate versions may have different packing units.

**For Snubber capacitors in 2-pin version the PCM is changing to 38.5 respective 49.5 mm. Samples and pre-production needs on request.

Rights reserved to amend design data without prior notification.

Updated data on www.wima.com



09618 Brand-Erbisdorf

WITTIG ELECTRONIC GMBH
Tel.: +49-37322/5280-0
info@wittig-electronic.de
www.wittig-electronic.de

59439 Holzwickede

SE SPEZIAL ELECTRONIC AG
Tel.: +49-2301/18480-0
dortmund@spezial.com
www.spezial.com

82178 Puchheim

TTI INC.
Tel.: +49-8142/6680-110
sales.munich@de.ttiinc.com
www.ttiinc.com

28359 Bremen

DISTRELEC GMBH
Tel.: +49-180/5223435
scc@distrelec.de
www.distrelec.de

12159 Berlin

WAIT ELECTRONIC GMBH
Tel.: +49-30/8512028
info@wait-electronic.de
www.waitelectronic.de

63263 Neu-Isenburg

ARROW CENTRAL EUROPE
Tel.: +49-6102/5030-0
vertrieb.frankfurt@arroweurope.com
www.arroweurope.com

85232 Günding

BECKMANN ELEKTRONIK
Tel.: +49-8131/3118-0
info@beckmann-elektronik.de
www.beckmann-elektronik.de

40789 Monheim am Rhein

SCHUKAT GMBH
Tel.: +49-2173/950960
info@schukat.com
www.schukat.com

30900 Wedemark

WTS//ELECTR. COMP. GMBH
Tel.: +49-5130/58450
info@wts-electronic.de
www.wts-electronic.de

72202 Nagold

NOVITRONIC GMBH
Tel.: +49-7452/8878020
info@novitronic.de
www.novitronic.com

85586 Poing

AVNET ABACUS
Tel.: +49-8121-77703
wima@avnet-abacus.eu
www.avnet-abacus.eu

80687 München

MOUSER
Tel.: +49-89/5204621-10
munich@mouser.com
www.mouser.com/wima

38112 Braunschweig

AL-ELEKTRONIK GMBH
Tel.: +49-531/256690
sales@al-elektronik.de
www.al-elektronik.de

75228 Ispringen

RUTRONIK GMBH
Tel.: +49-7231/801-0
rutronik@rutronik.com
www.rutronik.com

26452 Sande

REICHELT ELEKTRONIK
Tel.: +49-4422/955333
shop@reichelt.de
www.reichelt.de

Katalogdistribution

82041 Oberhaching

BÜRKLIN GMBH & CO.KG
Tel.: +49-89/55875-0
info@buerklin.de
www.buerklin.com

USA

DIGI-KEY
Tel.: +1-800 180 0125
eu.support@digikey.com
www.digikey.de

WIMA Sales Network Europe

Austria:

ARROW CENTRAL EUROPE
Wien
Tel.: +43-13604610
vertrieb.wien@arroweurope.com
www.arroweurope.com

Belgium/Luxembourg:

ACAL Bfi
Zaventem
Tel.: +32-27205983
sales-be@acalbfi.be
www.acalbfi.be

RUTRONIK GMBH

Sofia
Tel.: +359-29748646
rutronik_bg@rutronik.com
www.rutronik.com

TME CZECH REPUBLIC S.R.O.

Ostrava - Mariánské Hory
Tel.: +420-596633105
tme@tme.cz
www.tme.cz

AVNET ABACUS

Wien
Tel.: +43-186642-0
wien@avnet-abacus.eu
www.avnet-abacus.eu

ARROW CENTRAL EUROPE

Zaventem
Tel.: +32-27254660
salesoffice.brussels@arroweurope.com
www.arroweurope.com

Czech Republic:

ARROW ELECTRONICS
Praha
Tel.: +420-222755426
salesoffice.prague@arroweurope.com
www.arroweurope.com

TTI CZECH S.R.O.

Brno- Styrice
Tel.: +420-541126714
sales.brno@cz.ttiinc.com
www.ttiinc.com

RUTRONIK GMBH

Wels
Tel.: +43-724244901
rutronik_a@rutronik.com
www.rutronik.com

RUTRONIK GMBH

Erembodegem-Aalst
Tel.: +32-53739971
rutronik_b@rutronik.com
www.rutronik.com

ECOM S.R.O

Ceske Mezirici
Tel.: +420-494661188
sales@ecom.cz
www.ecom.cz

VIENNA COMP. TRADING S.R.O.

Senec u. Plzne
Tel.: +420-377824986
info@vicomtrade.cz
www.vicomtrade.cz

TTI GMBH

Wien
Tel.: +43-18798590
sales.vienna@at.ttiinc.com
www.ttiinc.com

Bulgaria:

COMET ELECTRONICS

Sofia
Tel.: +359-29155800
office@comet.bg
www.comet.bg

RUTRONIK CZ S.R.O.

Praha
Tel.: +420-233343120
rutronik_cz@rutronik.com
www.rutronik.com

WITTIG ELECTRONIC

Boskovice
Tel.: +420-515550805
wittig@wittig-electronic.cz
www.wittig-electronic.cz

**Denmark:****RUTRONIK GMBH**

Albertslund
Tel.: +45-70 20 19 63
rutronik_dk@rutronik.com
www.rutronik.com

TTI INC.

Brøndby
Tel.: +45-43 29 35 35
sales.copenhagen@dk.ttiinc.com
www.ttiinc.com

Estonia:**ARROW ESTONIA**

Tallinn
Tel.: +372-6 77 42 50
estonia@arroweurope.com
www.arrow.com

Finland:**ARROW NORDIC**

Espoo
Tel.: +358-9 47 66 60
finland@arrownordic.com
www.arrow.com

RUTRONIK GMBH

Helsinki
Tel.: +358-9 32 91 22 00
sales_finland@rutronik.com
www.rutronik.com

TTI FINLAND

Espoo
Tel.: +358-9 89 46 52 00
sales.finland@fi.ttiinc.com
www.ttiinc.com

YLEISELEKTRONIIKKA

Vantaa
Tel.: +358-1 02 89 12 20
sales@yeint.fi
www.yeint.fi

France:**ACTIPASS**

Toussus-le-Noble
Tel.: +33-1 69 81 61 10
sebastien.hennebert@actipass.fr

RUTRONIK SA

La Celle St. Cloud
Tel.: +33-1 30 08 33 00
rutronik_sas@rutronik.com
www.rutronik.com

TTI FRANCE

Brive-la-Gaillarde
Tel.: +33-5 55 92 92 93
sales.france@fr.ttiinc.com
www.ttiinc.com

Hungary:**ARROW ELECTRONICS**

Budapest
Tel.: +36-1 28 87 30 0
salesoffice.budapest@arroweurope.com
www.arrow.com

LOMEX

Budapest
Tel.: +36-2 75 42 02 0
info@lomex.hu
www.lomex.hu

RUTRONIK MAGYAROSZÁG

Budapest
Tel.: +36-1 23 13 34 9
rutronik_h@rutronik.com
www.rutronik.com

TME HUNGARY KFT.

Budapest
Tel.: +36-1 22 06 75 6
tme@tme.hu
www.tme.hu

TTI HUNGARY LTD.

Budapest
Tel.: +36-1 40 22 11 1
sales.budapest@hu.ttiinc.com
www.ttiinc.com

Ireland:**RUTRONIK LTD.**

Bolton
Tel.: +44-12 04 36 33 11
sales_uk@rutronik.com
www.rutronik.com

Italy:**RUTRONIK ITALIA**

Milano
Tel.: +39-02 40 95 11
italia_mi@rutronik.com
www.rutronik.com

S.G.E.-SYSCOM SPA.

Cinisello-Balsamo (MI)
Tel.: +39-02 61 79 01
info@sge-syscom.com
www.sge-syscom.com

TTI ITALIA

Milano
Tel.: +39-02 82 25 21
sales.milan@it.ttiinc.com
www.ttiinc.com

Lithuania:**RUTRONIK GMBH**

Kaunas
Tel.: +370 37 26 17 80
rutronik_lt@rutronik.com
www.rutronik.com

Netherlands:**ACAL BFI NEDERLAND**

Eindhoven
Tel.: +31-40 25 07 40 0
sales-nl@acalbfi.nl
www.acalbfi.nl

ARROW NL

Houten
Tel.: +31-30 63 91 23 4
salesoffice.utrecht@arroweurope.com
www.arrow.com

RUTRONIK GMBH

Breda
Tel.: +31-76 57 23 00 0
rutronik_nl@rutronik.com
www.rutronik.com

TTI OFFICE BENELUX

Eindhoven
Tel.: +31-40 29 01 61 6
sales.benelux@nl.ttiinc.com
www.ttiinc.com

Norway:**ACTE NORWAY AS**

Skedsmokorset
Tel.: +47-63 89 89 00
info@acte.no
www.acte.no

RUTRONIK GMBH

Oslo
Tel.: +47-22 76 79 20
sales_norway@rutronik.com
www.rutronik.com

Poland:**ARROW ELECTRONICS**

Warszawa
Tel.: +48-22 55 88 28 2
salesoffice.warsaw@arroweurope.com
www.arrow.com

MARITEX PHP SP. Z.O.O. SPK.

Gdynia
Tel.: +48-58 78 13 37 8
passive@maritex.com.pl
www.maritex.com.pl

RUTRONIK POLSKA

Gdynia
Tel.: +48-58 78 32 02 0
rutronik_pl@rutronik.com
www.rutronik.com

TME ELEKTRONIK

Lodz
Tel.: +48-42 64 55 45 4
wima@tme.pl
www.tme.pl

TTI POLAND

Kwidzyn
Tel.: +48-52 79 67 57
sales.poland@pl.ttiinc.com
www.ttiinc.com

Romania:**COMET ELECTRONICS S.R.L.**

Bucuresti
Tel.: +40-21 24 32 09 0
office@comet.srl.ro
www.comet.srl.ro

RUTRONIK GMBH

Timisoara
Tel.: +40-25 64 01 24 0
rutronik_ro@rutronik.com
www.rutronik.com

TME S.R.L.

Timisoara
Tel.: +40-35 64 67 40 1
tme@tme.ro
www.tme.eu/ro

Russia:**ARROW ELECTRONICS RUSSIA**

Moscow
Tel.: +7-495-62 65 59 7
salesoffice.moscow@arroweurope.com
www.arrow.com

GOLD GLOBE

Moscow
Tel.: +7-234 01 10
filsv@zolshar.ru
www.zolshar.ru

PT ELECTRONICS

Sankt-Petersburg
Tel.: +7-812 32 46 35 0
office@ptelectronics.ru
www.ptelectronics.ru

RUTRONIK GMBH

Moscow
Tel.: +7-499 96 33 18 4
rutronik_ru@rutronik.com
www.rutronik.com

TTI RUSSIA, ORION LLC

Sankt-Petersburg
Tel.: +7-812 49 62 05 3
sales.russia@ru.ttiinc.com
www.ttiinc.com

Slovakia:**ARROW ELECTRONICS**

Bratislava
Tel.: +421-23 26 04 3-00
salesoffice.bratislava@arroweurope.com
www.arrow.com

**RUTRONIK GMBH**

Banská Bystrica
Tel.: +421-48 47 223-00
rutronik_sk@rutronik.com
www.rutronik.com

WITTIG ELECTRONIC

Boskovice
Tel.: +420-51 55 50 805
wittig@wittig-electronic.cz
www.wittig-electronic.cz

Slovenia:**RUTRONIK GMBH**

Trzin
Tel.: +386 1 56 10 980
rutronik_si@rutronik.com
www.rutronik.com

Spain:**FACTRON S.A.**

Madrid
Tel.: +34-91 7 66 15 77
factron@factron.es
www.factron.es

RUTRONIK GMBH

Madrid
Tel.: +34-91 3005 528
rutronik_madrid@rutronik.com
www.rutronik.com

TTI SPAIN

Castelldefels/Barcelona
Tel.: +34 93 6452575
sales.barcelona@es.ttiinc.com
www.ttiinc.com

Sweden:**RUTRONIK NORDIC AB**

Kista
Tel.: +46-8 50 55 49 00
sales_sweden@rutronik.com
www.rutronik.com

TTI NORDIC AB

Upplands-Väsby
Tel.: +46-8 59 41 18 00
sales.stockholm@se.ttiinc.com
www.ttiinc.com

VANPEE AB

Bromma
Tel.: +46-8 44 52 80 0
info@vanpee.se
www.vanpee.se

Switzerland:**ARROW CENTRAL EUROPE**

Rümlang
Tel.: +41-44 81 76 26 2
vertrieb.zuerich@arroweurope.com
www.arroweurope.com

AVNET ABACUS

Dietikon
Tel.: +41-43 32 24 99 0
zurich@avnet-abacus.eu
www.avnet-abacus.eu

COMPONENTA

Schaffhausen
Tel.: +41-52 55 83 57 0
info@componenta.ch
www.componenta.ch

RUTRONIK AG

Volketswil
Tel.: +41-44 94 73 73 7
rutronik_ch@rutronik.com
www.rutronik.com

TTI INC.

Baar
Tel.: +41-41 76 74 19 0
sales.swiss@ch.ttiinc.com
www.ttiinc.com

Turkey:**ARROW ELECTRONICS**

Istanbul
Tel.: +90-216 53 81 20 0
www.arrow.com

RUTRONIK GMBH

Istanbul
rutronik_tr@rutronik.com
www.rutronik.com

TTI TURKEY

Istanbul
Tel.: +90-216 68 89 17 57 6
sales.turkey@tr.ttiinc.com
www.ttiinc.com

United Kingdom:**ANGLIA COMPONENTS LTD.**

Wisbech/Cambridgeshire
Tel.: +44-19 45-47 47 47
sales@anglia.com
www.anglia.com

ARROW ELECTRONICS

Harlow/Essex
Tel.: +44-12 79-44 11 44
salesoffice.london@arroweurope.com
www.arrow.com

DMTL

Sandhurst/Berkshire
Tel.: +44-12 76-33 39 1
info@dmrtl.co.uk
www.dmtl.co.uk

FUTURE EUROPE

Egham/Surrey
Tel.: +44-17 89-27 50 00
www.futureelectronics.com

TTI, INC.

Buckshire, High Wycombe
Tel.: +44-14 94-46 00 00
sales.london@uk.ttiinc.com
www.ttiinc.com

Ukraine:**ARROW ELECTRONICS**

Kiev
Tel.: +38-044-45 64 72 6
salesoffice.kiev@arroweurope.com
www.arrow.com

PT ELECTRONICS

Kiev
Tel.: +38-044-23 00 18 1
office@i-p.com.ua
www.ptelectronics.ru

WIMA Sales Network International**Australia:****ARROW ELECTRONICS**

North Bayswater, Victoria
Tel.: +61-3-97 37-49 00
www.arrowasia.com

Brasil:**FUTURE ELECTRONICS**

São Paulo
Tel.: +55 19 37 37 41 00
www.futureelectronics.com

Canada:**FUTURE ELECTRONICS**

Quebec
Tel.: +1-514-694-77 10
www.futureelectronics.com

TTI INC.

Toronto
Tel.: +1-905-850-3003
information@ttiinc.com
www.ttiinc.com

China:**HUBEI BLUESKY CO. LTD.**

Wuhan
Tel.: +86-27-83 64 06 06
bluesky0@public.wh.hb.cn
www.webluesky.com

NANCO LTD.

Hong Kong
Tel.: +852-27 65-30 80
info@nanco.com
www.nanco.com

Shanghai

Tel.: +86-21-64 66-38 58
nnsh@sh163.net
www.nanco.com

SEKORM

Shenzhen
Tel.: 400 887 32 66
service@sekorm.com
www.sekorm.com

SUFFICE LTD.

Beijing
Tel.: +86 10 6594-9269
beijing@suffice.com.cn
www.suffice-group.com

Guangzhou

Tel.: +86-20- 8363 3545
guangzhou@suffice.com.cn

Hong Kong

Tel.: +852-23 43-75 63
mail@suffice.com.hk

Shanghai

Tel.: +86-21-64 68 20 12
shanghai@suffice.com.cn

Shenzhen

Tel.: +86 755 8359-3381
shenzhen@suffice.com.cn

TTI INC.

Hong Kong
Tel.: +852-36 58-47 00
feedbacktiasia@ttiinc.com
www.tiasia.com

Shanghai

Tel.: +86-21-51 74-20 88
feedbacktiasia@ttiinc.com

Shenzhen

Tel.: +86 755 8386-5857
feedbacktiasia@ttiinc.com

Suzhou

Telefon: +86 512 8885-9626
feedbacktiasia@ttiinc.com

**India:****ARIHANT ELECTRICALS**

New Delhi
Tel.: +91-11-23262176
info@arihantelectricals.com
www.arihantelectricals.com

ARROW ELECTRONICS

Bangalore
Tel.: +91-80-41353800
www.arrowasia.com

SUPREME COMP. INT. PTE. LTD.

Bangalore
Tel.: +91-8028482650
sales@supremecomponents.com
www.supremecomponents.com

Israel:**M.G.R. TECHNOLOGIES LTD.**

Rehovot
Tel.: +972-8-9477577
mgr@mgr.co.il
www.mgr.co.il

TTI, Inc.

Raanana
Tel.: +972-9-7783010
sales.israel@il.ttiinc.com
www.ttiinc.com

Japan:**AVNET K.K.**

Tokyo
Tel.: +81-357929700
sales@avnet.co.jp
www.avnet.co.jp

FUJI ELECTRIC IND. CO., LTD.

Osaka
Tel.: +81-6-64455807
www.fujidensan.co.jp

Malaysia:**SUPREME COMP. INT. PTE. LTD.**

Selangor
Tel.: +60123799519
sales@supremecomponents.com
www.supremecomponents.com

TRENDTRONICS (S) PTE. LTD.

Singapore
Tel.: +65-62762633
trend@asiainmail.com
www.trendtronics.com.sg

Mexico:**FUTURE ELECTRONICS**

Col. El Yaqui, Del. Cuajimalpa
Tel.: +52-5540400002
www.futureelectronics.com

TTI, INC.

Tlaquepaque, Jalisco
Tel.: +1-800-225-5884
www.ttiinc.com

New Zealand:**ACTIVE COMPONENTS**

Auckland
Tel.: +64-9-443-9500
sales@activecomponents.com
www.activecomponents.com

ARROW COMPONENTS (NZ)

Christchurch
Tel.: +64-3-366-2000
www.arrowasia.com

Philippines:**SUPREME COMP. INT. PTE. LTD.**

Singapore
Tel.: +65-68481178
sales@supremecomponents.com
www.supremecomponents.com

TTI ELECTRONICS ASIA

Pasig
Tel.: +63-26545599
feedbacktiasia@ttiinc.com
www.ttiasia.com

Singapore:**FUTURE ASIA**

Singapore
Tel.: +65-68083888
www.futureelectronics.com

SUPREME COMP. INT. PTE. LTD.

Singapore
Tel.: +65-68481178
sales@supremecomponents.com
www.supremecomponents.com

TRENDTRONICS (S) PTE. LTD.

Singapore
Tel.: +65-62762633
trend@asiainmail.com
www.trendtronics.com.sg

TTI ELECTRONICS ASIA

Singapore
Tel.: +65-6788-9200
feedbacktiasia@ttiinc.com
www.ttiasia.com

South Africa:**AVNET KOPP (PTY.) LTD.**

Woodmead
Tel.: +27-11-319-8600
sales@avnet.co.za
www.avnet.co.za

South Korea:**YONG JUN ELECTRONIC CO.**

Seoul
Tel.: +82-2-536-5121
yc97@yongjun.co.kr
www.yongjun.co.kr

Taiwan:**DESCARTES LTD.**

Taipei
Tel.: +886-2-2393-9677
sales@descartes.com.tw
www.descartes.com.tw

NANCO LTD.

Taipei
Tel.: +886-2-2545-6058
nntw@nanco.com.tw
www.nanco.com

SOLOMON TECHNOLOGY

Taipei
Tel.: +886-2-8791-8989
sales@solomon.com.tw
www.solomon.com.tw

SUFFICE TAIWAN

Taipei
Tel.: +886-2-2792-4360
mail@suffice.com.hk
www.suffice-group.com

TTI ELECTRONICS ASIA

Taipei
Tel.: +886-2-27968305
feedbacktiasia@ttiinc.com
www.ttiasia.com

Thailand:**NATTHAPONG CO. LTD.**

Bangkok
Tel.: +66-2-2250094
npe@npe.co.th
www.mynpe.com

SUPREME COMP. INT. PTE. LTD.

Bangkok
Tel.: +66-6-15454625
sales@supremecomponents.com
www.supremecomponents.com

TRENDTRONICS (S) PTE. LTD.

Singapore
Tel.: +65-62762633
trend@asiainmail.com
www.trendtronics.com.sg

TTI ELECTRONICS ASIA

Bangkok
Tel.: +66-2-6942277
feedbacktiasia@ttiinc.com
www.ttiasia.com

USA:**DIGI-KEY**

Thief River Falls, MN
Tel.: +1-800-344-4539
sales@digikey.com
www.digikey.com

FUTURE ELECTRONICS

Quebec, Canada
Tel.: +1-514-694-7710
www.futureelectronics.com

MOUSER ELECTRONICS, INC.

Mansfield, TX
Tel.: +1-800-346-6873
sales@mouser.com
www.mouser.com

TAW ELECTRONICS, INC.

Los Angeles, CA
Tel.: +1-818-846-3911
sales@tawelectronics.com
www.tawelectronics.com

TLC ELECTRONICS

St. Paul, MN
Tel.: +1-833-600-0364
customerservice@tlcelectronics.com
www.tlcelectronics.com

TTI INC.

Fort Worth, TX
Tel.: +1-800-275-4884
information@ttiinc.com
www.ttiinc.com